

LDO Regulator

Features

- Output Current 300mA or more
- Ultra-Low-Noise for RF Application:
- 30μVRMS @1.2V
- Quick Start-Up (Typically 50μs)
- Dropout Voltage: 270mV@300mA for 3.3V
- Wide Operating Voltage Range: 1.8V to 5.5V
- Output Voltage Range: 1.2V to 3.3V(100 mV Step)
- Standby Current: 0.1μA
- High Ripple Rejection: 80dB@1kHz
- Output Current-Limit Protection
- Thermal Shutdown Protection
- Operating Temperature Range: -40 ~+85
- Low ESR Capacitor compatible: Ceramic capacitor
- Lead Free and Green Package: SOT23-5L, SC70-5L, TDFN-6L 1.8×2

Pin Configuration

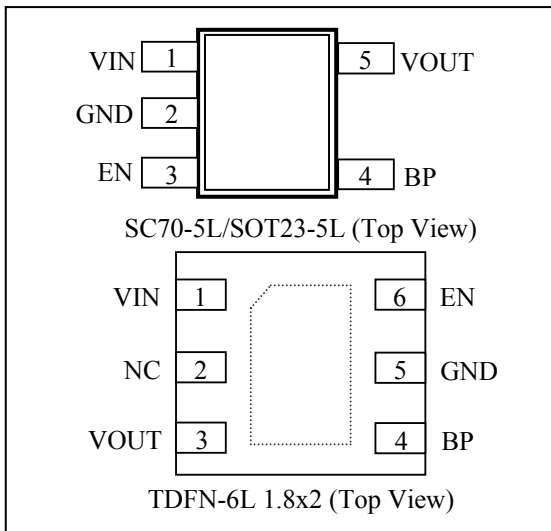

Description

The PT7M8202 series are highly accurate, low dropout voltage regulators with low noise, high ripple rejection and low current consumption for portable RF and wireless applications.

The PT7M8202 includes a reference voltage source, an error amplifier, a driver transistor, a current limit protection, a thermal protection and an internal phase compensator.

A noise bypass pin is available for further reduction of output noise.

The output voltage for the regulator is set by factory trimming within a range of 1.2V to 3.3V in 100mV step includes 2.85V. The PT7M8202 series are stable with low ESR ceramic capacitors.

Applications

- Mobile phones (PDC, GSM, CDMA, IMT2000 etc.)
- Cordless phones and radio communication
- Digital still cameras and video cameras
- PDAs
- MP3 players
- Portable devices

Pin Description

Pin No. for SOT23-5L/SC70-5L	TDFN-6L	I/O	Name	Descriptions
1	1	I	VIN	Regulator Supply Input. Supply voltage can range from 1.8V to 5.5V. Bypass with a 1μF ceramic capacitor (X5R/X7R) to GND.
2	5	P	GND	Ground.
3	6	I	EN	ON/OFF Control of Regulator.
4	4	-	BP	Reference Noise Bypass.
5	3	O	VOUT	Output of Regulator. Bypass with a 1μF ceramic capacitor (X5R/X7R) to GND.
-	2	-	NC	No Connection.

Maximum Ratings

Storage Temperature.....	-55 to +125
Ambient Temperature with Power Applied.....	-40 to +85
Input Voltage.....	+6.0V
Output Voltage	-0.3 to V _{CC} +0.3V
EN pin Voltage.....	+6.0V
DC Input/Output Current	700mA
Power Dissipation.....	SOT23/400mW SC70/300mW TDFN/600mW

Note:

Stresses greater than those listed under MAXIMUM RATINGS may cause permanent damage to the device. This is a stress rating only and functional operation of the device at these or any other conditions above those indicated in the operational sections of this specification is not implied. Exposure to absolute maximum rating conditions for extended periods may affect reliability.

Recommended Operating Conditions

Symbol	Parameter	Min.	Typ.	Max.	Unit
V _{CC}	Operating Voltage	1.8	-	5.5	V
T _A	Operating temperature	-40	25	85	°C

Electrical Characteristics (T_A=25 °C, Bypass capacitor=22nF)

Parameter	Symbol	Conditions	Min.	Typ.	Max.	Unit	
Output Voltage	V _{OUT(E)} *2	V _{IN} =V _{OUT(S)} *1+1.0V, I _{OUT} =30mA	V _{OUT(S)} *0.98	V _{OUT(S)}	V _{OUT(S)} *1.02	V	
Maximum Output Current	I _{OUTMAX}	V _{IN} =V _{OUT(S)} +1.0V	300	-	-	mA	
Dropout Voltage	V _{dif} *3	I _{OUT} = 300mA	1.7V ≤ V _{OUT(S)} ≤ 1.8V	-	0.39	0.51	V
			1.9V ≤ V _{OUT(S)} ≤ 2.3V	-	0.33	0.43	
			2.4V ≤ V _{OUT(S)} ≤ 2.7V	-	0.30	0.39	
			2.8V ≤ V _{OUT(S)} ≤ 3.3V	-	0.27	0.35	
Supply Current	I _{SS}	V _{IN} = V _{OUT(S)} + 1.0V, no load	-	70	100	μA	
Standby Current	I _{SB}	V _{IN} = V _{OUT(S)} +1.0V EN=OFF	-	0.1	1	μA	
Line Regulation	$\frac{\Delta V_{OUT}}{\Delta V_{IN}} * V_{OUT}$	V _{OUT(S)} +1.0V ≤ V _{IN} ≤ 5.5V I _{OUT} =30 mA	-	0.05	0.2	%/V	
Load Regulation	ΔV _{OUT2}	V _{IN} = V _{OUT(S)} +1.0V, 1.0mA ≤ I _{OUT} ≤ 300mA	-	-	0.6	%	
Input Voltage	V _{IN}	-	1.8	-	5.5	V	
Output Voltage Temperature Characteristic	$\frac{\Delta V_{OUT}}{\Delta T_{opr}} * V_{OUT}$	I _{OUT} =30 mA -40 ≤ T _{opr} ≤ 85	-	+/-100	-	ppm/	
Ripple Rejection	PSRR	V _{IN} =[V _{OUT(S)} +1.0]V _{DC} +1V _{p-p} AC V _{OUT} =1.5V, I _{OUT} =30mA, f=1kHz	-	80	-	dB	
Current Limit	I _{LIM}	V _{OUT} = V _{OUT(S)} *0.9	-	450	-	mA	
Thermal Shutdown	T _{SD}			170			
Thermal Shutdown Hysteresis	ΔT _{SD}			40			
EN"High" Voltage	V _{ENH}	-	1.5	-	-	V	
EN"Low" Voltage	V _{ENL}	-	-	-	0.3		
EN"High" Current	I _{ENH}	V _{IN} =V _{OUT(S)} +1.0V	-0.10	-	0.10	μA	
EN"Low" Current	I _{ENL}	V _{IN} = V _{OUT(S)} +1.0V, EN=OFF	-0.10	-	0.10		
Output Discharge Resistance	R _{dis}	V _{IN} = V _{OUT(S)} +1.0V EN=OFF	-	200	-	Ω	
Output Noise Voltage	e _{ON}	V _{OUT} =1.2V , 10Hz to 100kHz, I _{OUT} =30mA, C _{OUT} =1μF	-	30	-	μV _{RMS}	

- Note:**
- *1: V_{OUT(S)}=Specified output voltage.
 - *2: V_{OUT(E)}=Effective output voltage.
 - (I.e. the output voltage when "V_{OUT(S)}+1.0V" is provided at the VIN pin while maintaining a certain I_{OUT} value).
 - *3: V_{dif}={V_{IN}^(*)-V_{OUT1}^(*)}.
 - *4: V_{OUT1}=A voltage equal to 98% of the output voltage whenever an amply stabilized I_{OUT} {V_{OUT(S)} + 1.0V} is input.
 - *5: V_{IN1}=The input voltage when V_{OUT1} appears as input voltage is gradually decreased.
 - *6: Unless otherwise stated, V_{IN}=V_{OUT(S)}+1.0V

Typical Performance and Characteristics

1. Output Voltage vs. Output Current

PT7M8202 (1.2V)

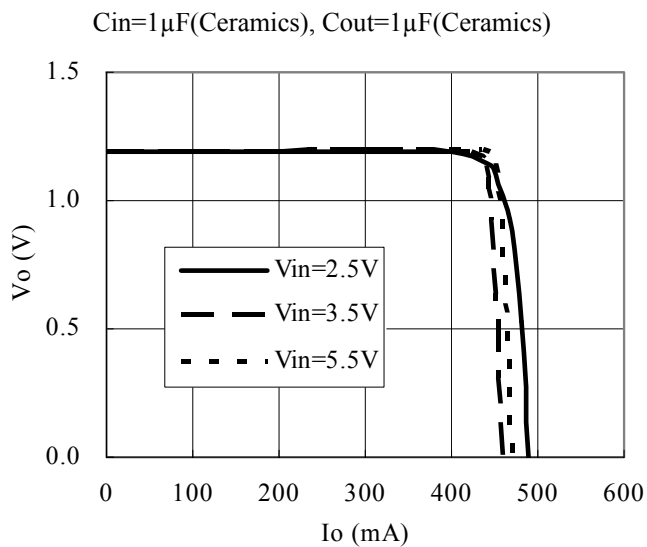

PT7M8202 (3.3V)

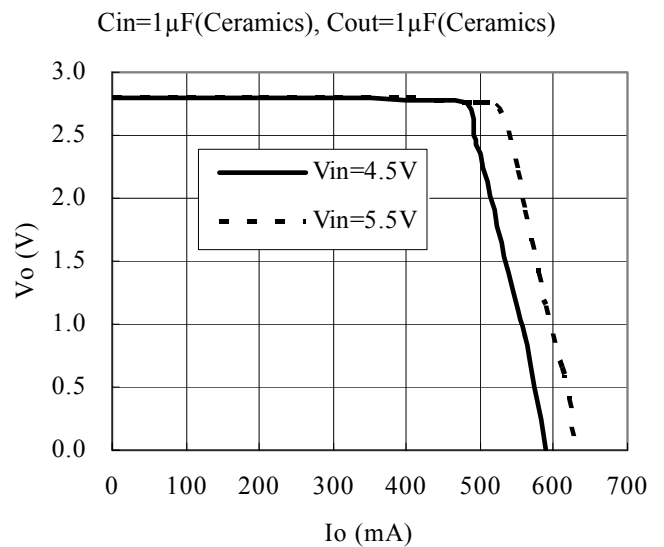

2. Output Voltage vs. Input Voltage

PT7M8202 (1.2V)

Topr=25

Cin=1 μ F(Ceramics), Cout=1 μ F(Ceramics)

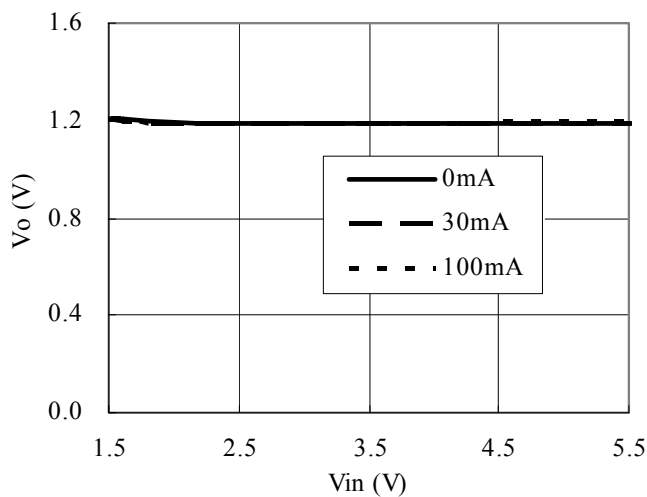

PT7M8202 (3.3V)

Topr=25

Cin=1 μ F(Ceramics), Cout=1 μ F(Ceramics)

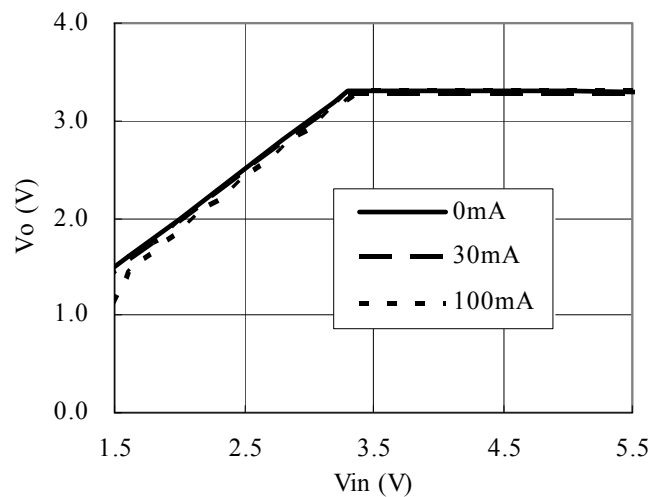

3. Supply Current vs. Input Voltage

PT7M8202 (1.2V)

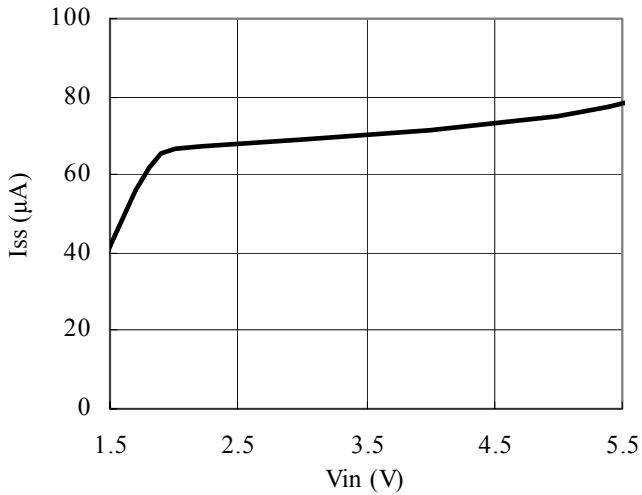

PT7M8202 (3.3V)

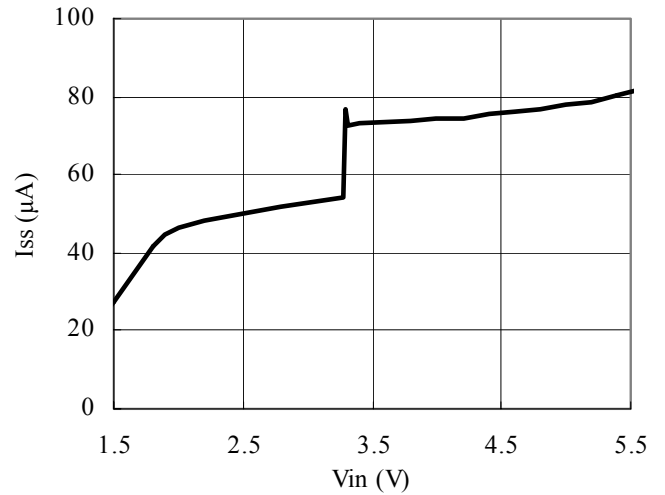

4. Dropout Voltage vs. Output Current

PT7M8202 (3.3V)

Cin=1µF(Ceramics), Cout=1µF(Ceramics)

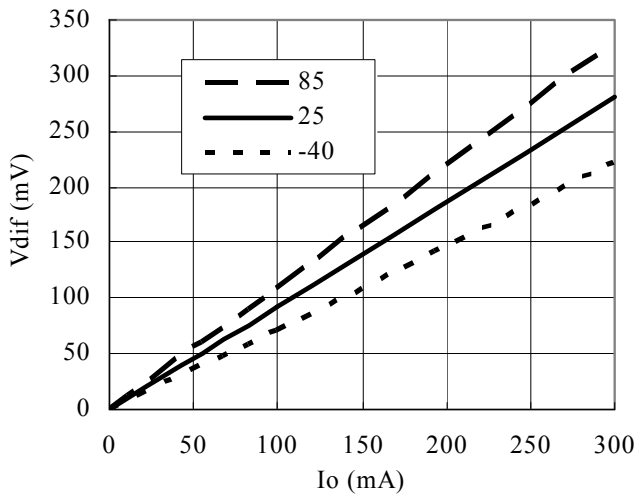

5. Line Transient Response

PT7M8202 (3.3V)

Cin=Cout=1µF(Ceramics), Iout=100mA
Time (50µs/Div)

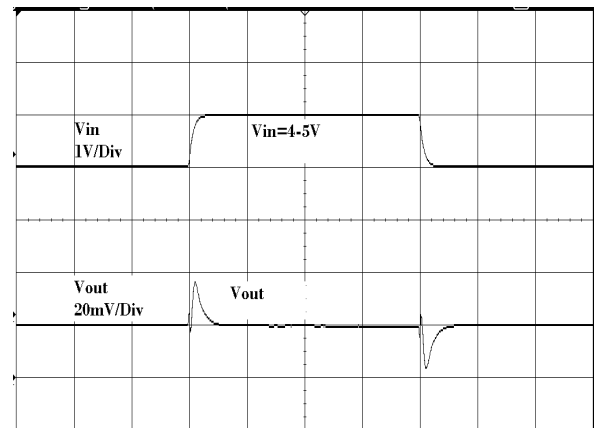

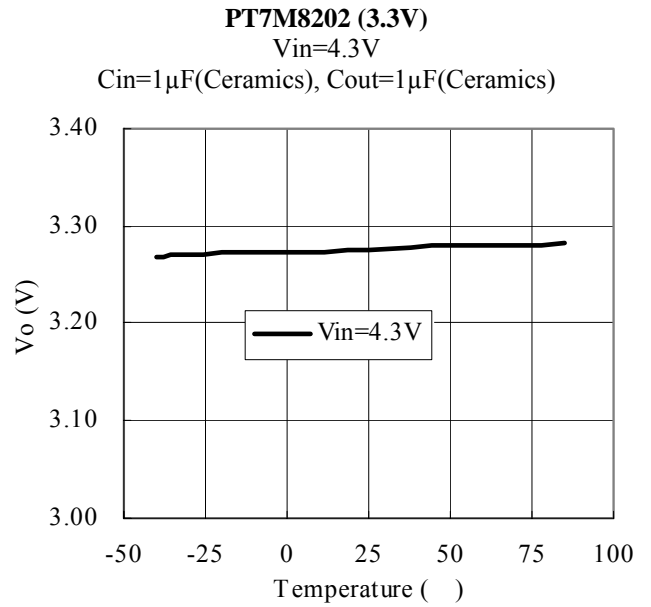
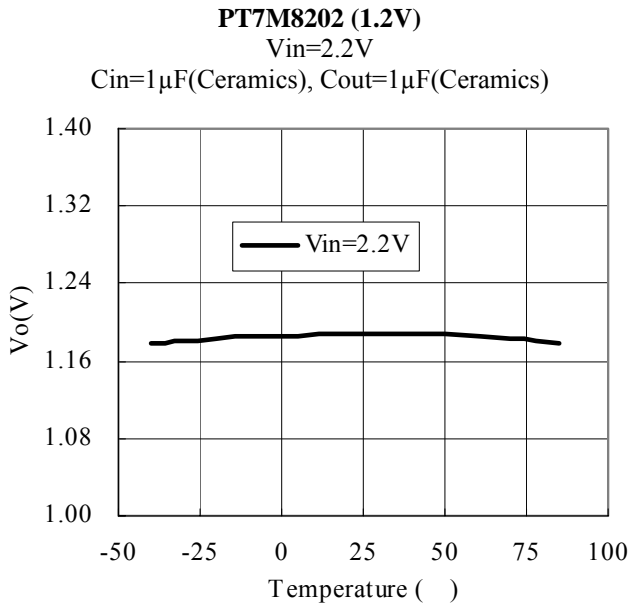
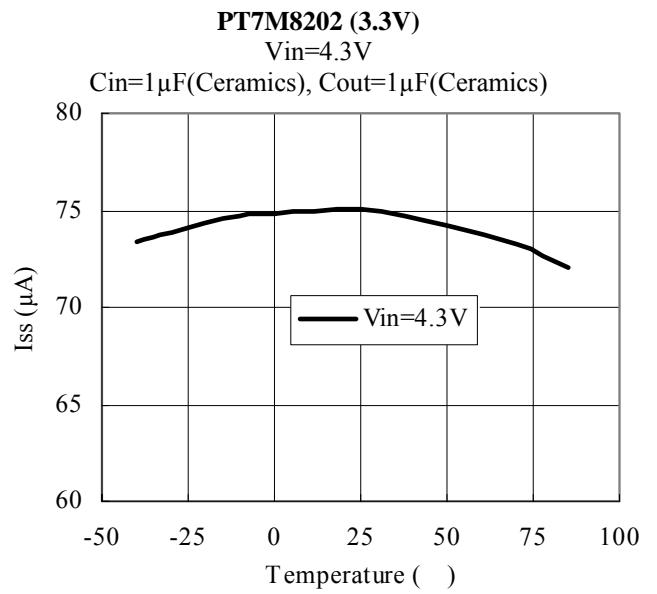
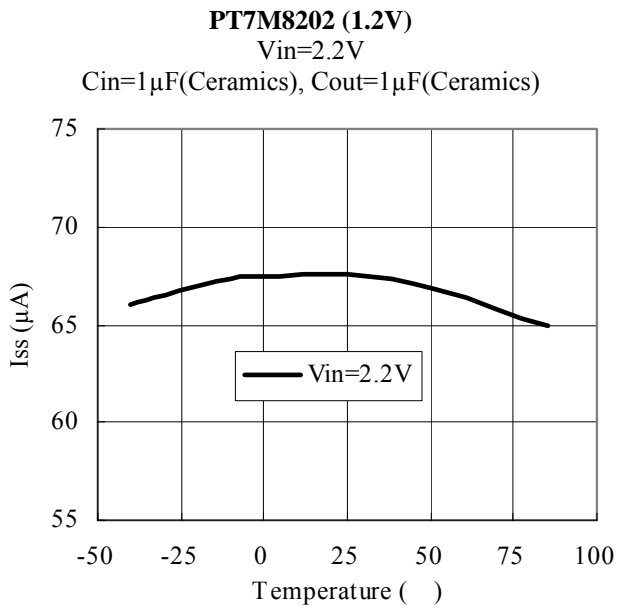
6. Output Voltage vs. Ambient Temperature

7. Supply Current vs. Ambient Temperature

8. Load Transient Response

PT7M8202 (3.3V)

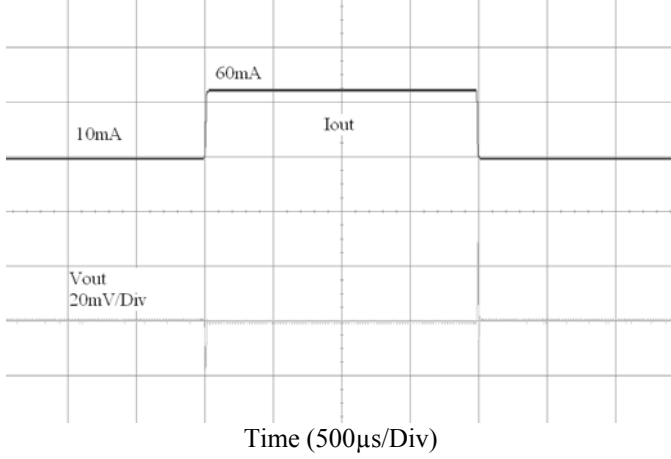
Cin= Cout=1 μ F(Ceramics), Vin=4.3V



PT7M8202 (3.3V)

Cin= Cout=1 μ F(Ceramics), Vin=4.3V

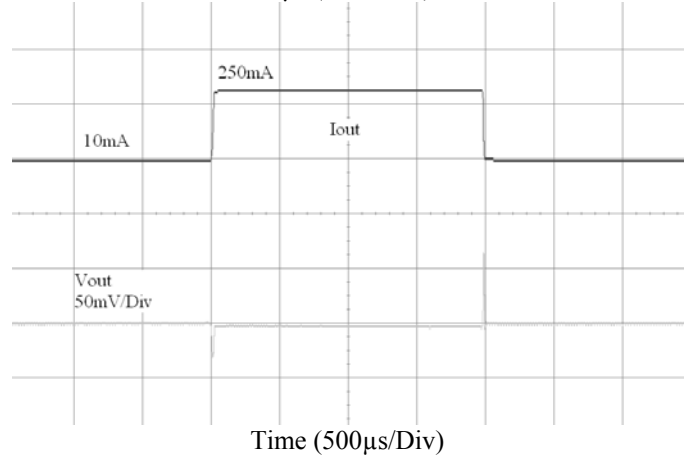

9. PSRR

PT7M8202 (1.2V)

Vin=2.2V DC+1Vp-pAC
Cout=1 μ F(Ceramics), Iout=30mA

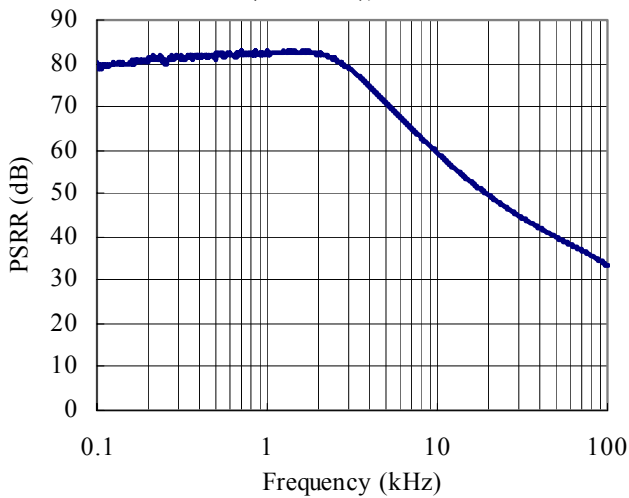

Function block diagram

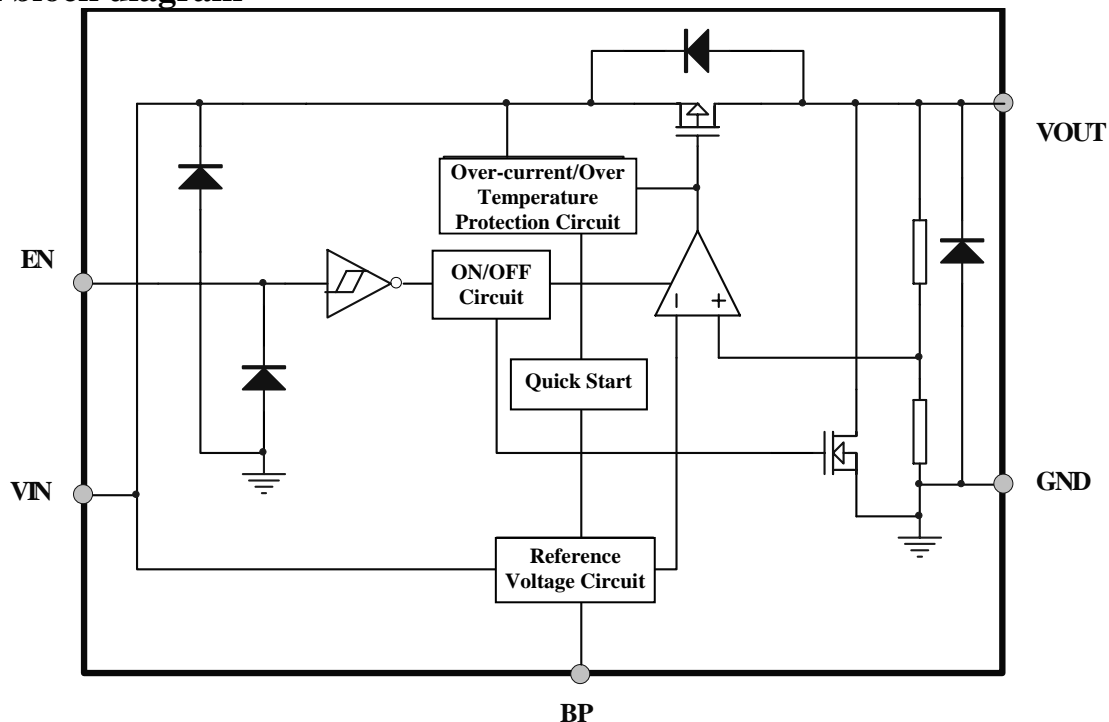

Functional Description *(Refer to Function Block Diagram)*

Output Voltage

The divided output voltage is compared with the internal reference voltage by the error amplifier with internal phase compensator. The output of the error amplifier then drives the P-channel MOSFET to maintain a stable and constant output voltage.

Low ESR Capacitors

The internal phase compensator maintains the stable output voltage with low ESR ceramic input and output capacitors. 1 μ F low ESR (X5R/X7R) ceramic capacitor located as close as possible to the IC's pins is recommended.

Current Limit and Thermal Shutdown Protections

Current limit protection is used to limit the output current when an overload condition occurs. As a result, the output voltage will drop. Thermal shutdown protection will turn off the output to reduce the power dissipation when the operation junction temperature exceeds 170°C.

Bypass Capacitor and Low Noise

A 22nF between the BP pin and GND pin significantly reduces noise on the regulator output, it is critical that the capacitor connection between the BP pin and GND pin be direct and PCB traces should be as short as possible. There is a relationship between the bypass capacitor value and the LDO regulator turn on time. DC leakage on this pin can affect the LDO regulator output noise and voltage regulation performance.

EN Pin

The output of the regulator in PT7M8202A/B can be controlled with EN pin. The EN pin should be connected to a "VIN" or a "GND" voltage as a floating input applied to inverter input of the enable circuitry will increase the current consumption.

■ NOTE ON USE

1. Please use this IC within the stated absolute maximum ratings.
2. Where wiring impedance is high, operations may become unstable due to noise and/or phase lag depending on output current. Please keep the resistance low between VIN and GND wiring in particular.
3. Please wire the input capacitor (C_{in}) and the output capacitor (C_{out}) as close to the IC as possible.

Application Circuit

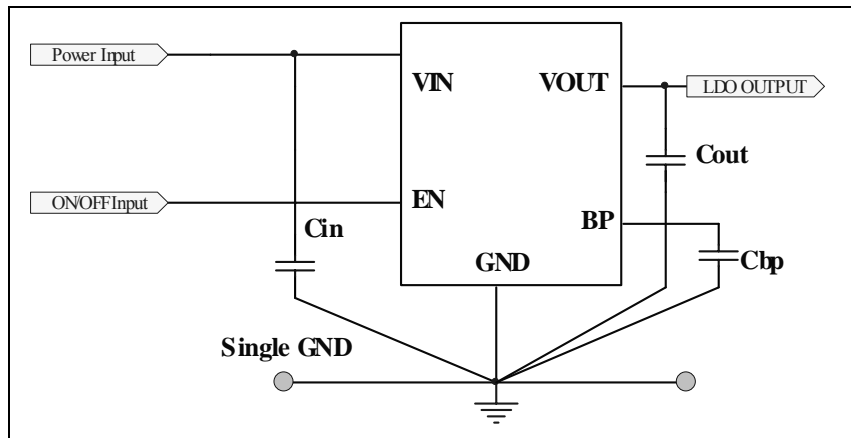

Note: $C_{in}=C_{out}=1\mu F$, $C_{bp}=22nF$

Mechanical Information
TA5 (SOT23-5L)

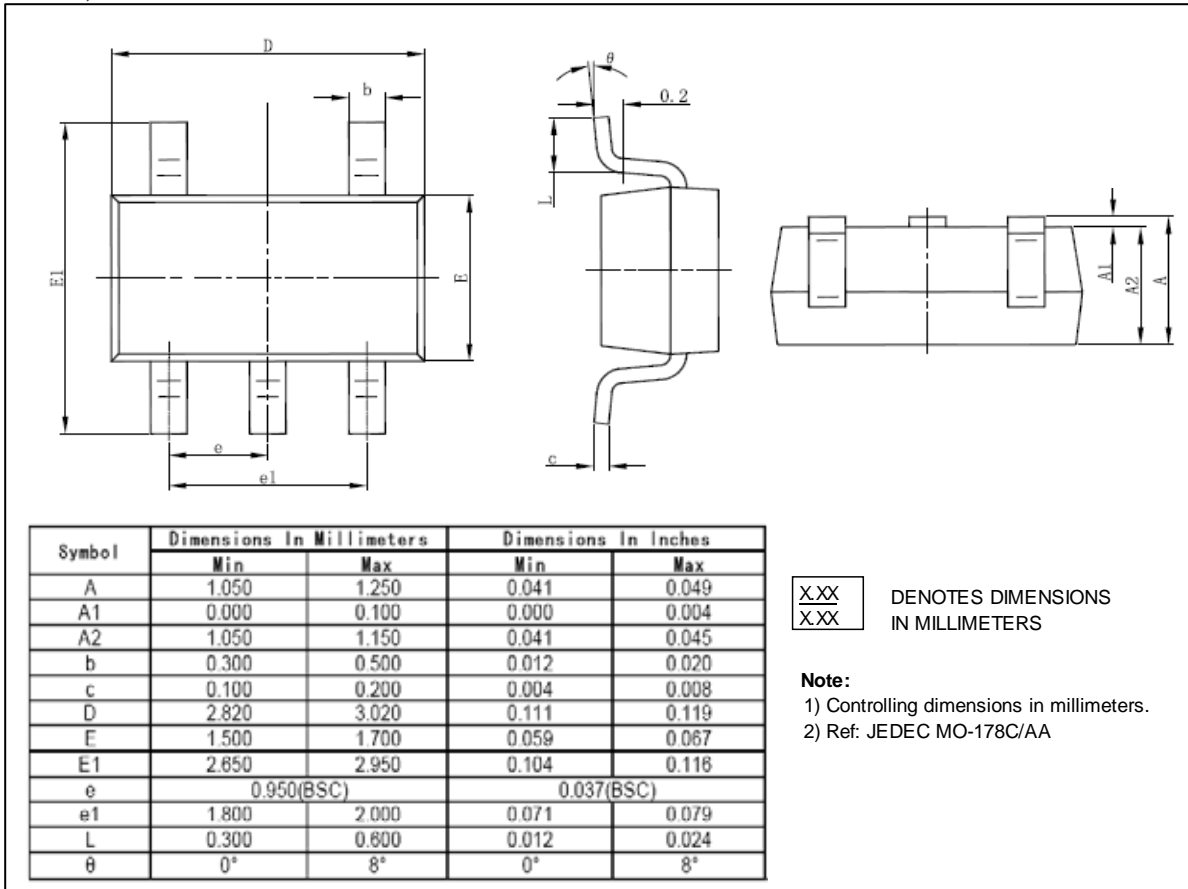

C5 (SC70-5L)

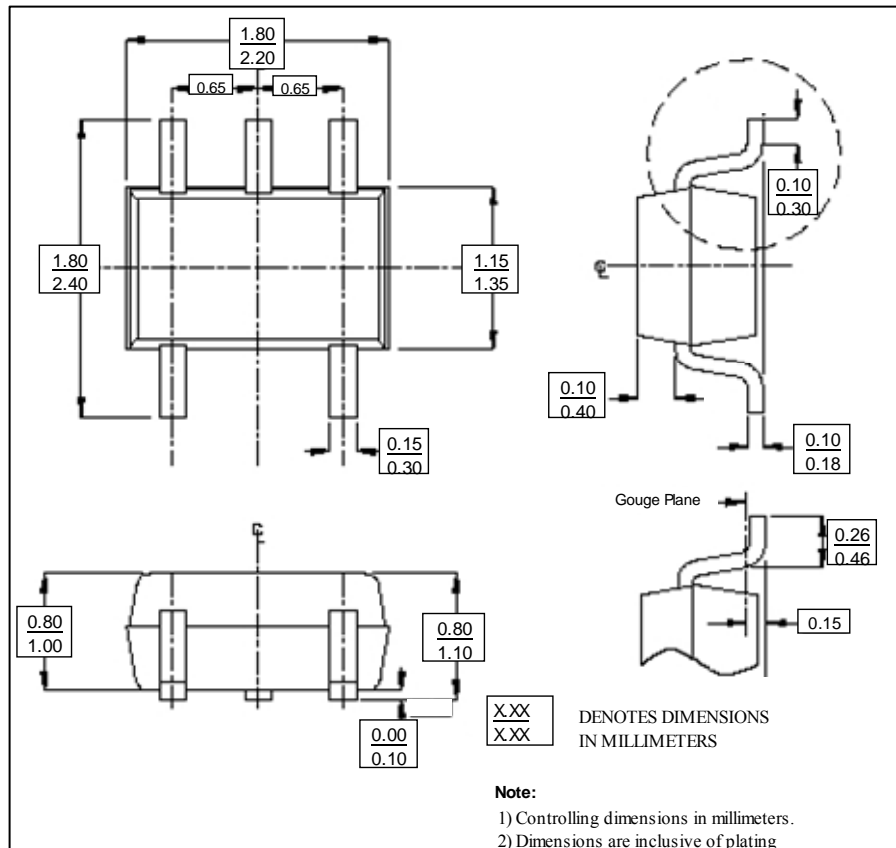

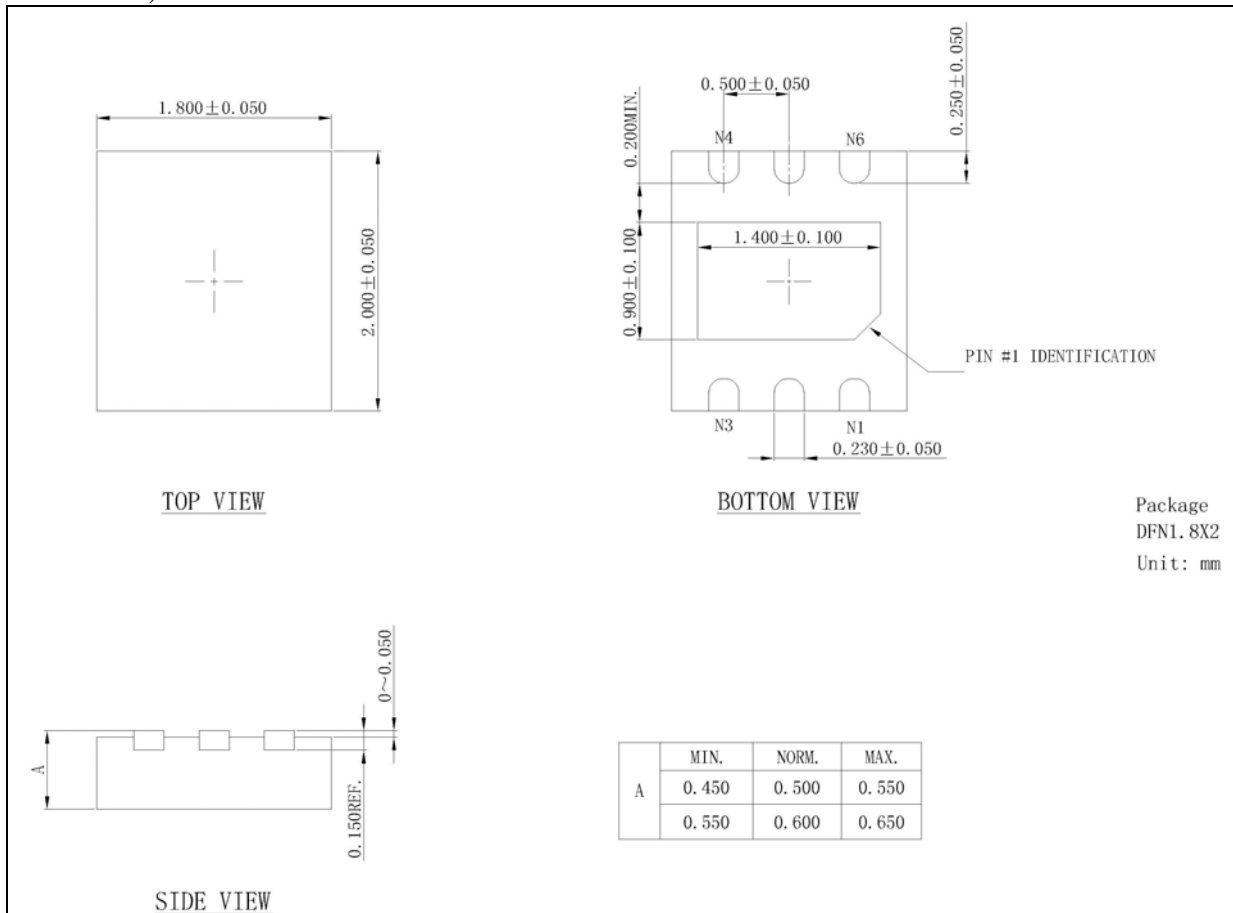
ZE(TDFN-6L 1.8x2)

Ordering Information

Part Number		Package Code	Package
PT7M8202	TA5E	TA5	Lead free and Green SOT23-5L
PT7M8202	C5E	C5	Lead free and Green SC70-5L
PT7M8202	ZEE	ZE	Lead free and Green TDFN-6L

Notes:

- “ ” refer to different functions. See below Table 1 and Table 2.
- E = Pb-free and Green
- Adding X Suffix= Tape/Reel

Table 1 Option Definition Table

Designator	Symbol	Description
Regulators EN type	A	Low active
	B	High active
Regulator Output voltage	12-33, 2A	Internally set sequential number relating output voltage of regulator , the detail is in Table 2

Table 2 Definition of designator

Designator	VOUT (V)	Designator	VOUT (V)	Designator	VOUT (V)
12	1.2	20	2.0	28	2.8
13	1.3	21	2.1	29	2.9
14	1.4	22	2.2	30	3.0
15	1.5	23	2.3	31	3.1
16	1.6	24	2.4	32	3.2
17	1.7	25	2.5	33	3.3
18	1.8	26	2.6	2A	2.85
19	1.9	27	2.7		