

## 2.5V/3.3V, High Bandwidth, Hot Insertion 16-Bit, 2-Port, Bus Switch

### Features

- Near-Zero propagation delay
- 5-ohm switches connect inputs to outputs
- Permits Hot Insertion
- Capable of Hot-Swapping
- 5V I/O Tolerant
- 2.5V Supply Voltage Operation
- Rail-to-Rail 3.3V or 2.5V Switching
- High Bandwidth Operation (>400 MHz)
- Packaging (Pb-free & Green):
  - 40-pin, 150-mil-wide plastic BQSOP (B)

### Description

Pericom Semiconductor's PI3C32X245 is a 2.5V or 3.3V 16-bit, 2-port bus switch designed with a low On-Resistance (5-ohm) allowing inputs to be connected directly to outputs. The bus switch creates no additional propagational delay or additional ground bounce noise. The switches are turned ON by the Bus Enable ( $\overline{BE}_N$ ) input signal. It is very useful in switching signals that have high bandwidth (>400 MHz).

### Block Diagram

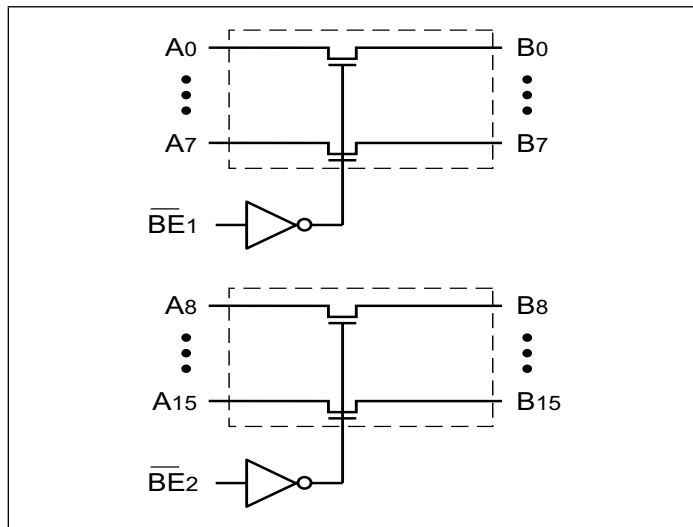

### Pin Configuration

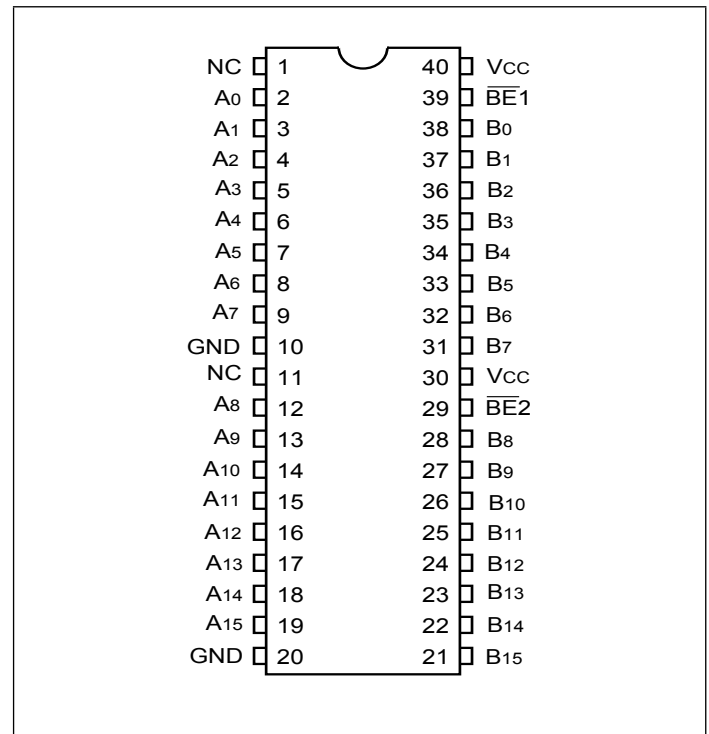

### Truth Table<sup>(1)</sup>

Function	$\overline{BE}_N$	A0-15
Disconnect	H	Hi-Z
Connect	L	B0-15

Note: H = High Voltage Level  
L = Low Voltage Level  
Hi-Z = High Impedance

### Pin Description

Pin Name	Description
$\overline{BE}_N$	Bus Enable Input (Active LOW)
A0-15	Bus A
B0-15	Bus B

### Absolute Maximum Ratings

Parameter	Min.	Max.	Units
Storage Temperature	-65	150	°C
Ambient Temperature with Power Applied	-40	85	°C
Supply Voltage to Ground Potential (Inputs & V <sub>CC</sub> Only)	-0.5	4.6	V
Supply Voltage to Ground Potential (Outputs & D/O Only)	-0.5	4.6	V
DC Input Voltage	-0.5	5.5	V
DC Output Current	-	120	mA
Power Dissipation	-	0.5	W

Stress beyond those listed under “Absolute Maximum Ratings” may cause permanent damage to the device.

### DC Electrical Characteristics (Over the Operating Range, T<sub>A</sub> = -40°C to +85°C, V<sub>CC</sub> = 3.3V ±10%)

Parameters	Description	Test Conditions <sup>(1)</sup>	Min	Typ <sup>(2)</sup>	Max	Units
V <sub>IH</sub>	Input HIGH Voltage	Guaranteed Logic HIGH Level	2.0			V
V <sub>IL</sub>	Input LOW Voltage	Guaranteed Logic LOW Level	-0.5		0.8	V
I <sub>IH</sub>	Input HIGH Current	V <sub>CC</sub> = Max., V <sub>IN</sub> = V <sub>CC</sub>			±1	μA
I <sub>IL</sub>	Input LOW Current	V <sub>CC</sub> = Max., V <sub>IN</sub> = GND			±1	
I <sub>OZH</sub>	High Impedance Output Current	0 ≤ A, B ≤ V <sub>CC</sub>			±1	
V <sub>IK</sub>	Clamp Diode Voltage	V <sub>CC</sub> = Min., I <sub>IN</sub> = -18 mA		-0.73	-1.2	V
R <sub>ON</sub>	Switch On Resistance <sup>(4)</sup>	V <sub>CC</sub> = Min., V <sub>IN</sub> = 0.0V, I <sub>ON</sub> = 48mA		5	7	Ω
		V <sub>CC</sub> = Min, V <sub>IN</sub> = 2.4V, I <sub>ON</sub> = 15mA		8	15	

### Capacitance (T<sub>A</sub> = 25°C, f = 1 MHz)

Parameters <sup>(5)</sup>	Description	Test Conditions	Typ	Units
C <sub>IN</sub>	Input Capacitance	V <sub>IN</sub> = 0V	3.5	pF
C <sub>OFF</sub>	A/B Capacitance, Switch Off	V <sub>IN</sub> = 0V	5.0	pF
C <sub>ON</sub>	A/B Capacitance, Switch On	V <sub>IN</sub> = 0V	10.0	pF

Notes:

- For Max. or Min. conditions, use appropriate value specified under Electrical Characteristics for the applicable device type.
- Typical values are at V<sub>CC</sub> = 3.3V, T<sub>A</sub> = 25°C ambient and maximum loading.
- Not more than one output should be shorted at one time. Duration of the test should not exceed one second.
- Measured by the voltage drop between A and B pin at indicated current through the switch. ON resistance is determined by the lower of the voltages on the two (A,B) pins.

### Power Supply Characteristics

Parameters	Description	Test Conditions <sup>(1)</sup>		Min	Typ <sup>(2)</sup>	Max	Units
I <sub>CC</sub>	Quiescent Power Supply Current	V <sub>CC</sub> = Max.	V <sub>IN</sub> = GND or V <sub>CC</sub>		0.5	1.0	mA
ΔI <sub>CC</sub>	Supply Current per Input HIGH	V <sub>CC</sub> = Max.	V <sub>IN</sub> = 3.0V <sup>(3)</sup>			2.5	

Notes:

1. For Max. or Min. conditions, use appropriate value specified under Electrical Characteristics for the applicable device.
2. Typical values are at V<sub>CC</sub> = 3.3V, +25°C ambient.
3. Per TTL driven input (control input only); A and B pins do not contribute to ΔI<sub>CC</sub>.

### Switching Characteristics over 3.3V Operating Range

Parameters	Description	Test Conditions	P13C32X245		Units
			Com.		
			Min	Max	
t <sub>PLH</sub> t <sub>PHL</sub>	Propagation Delay <sup>(2,3)</sup> Ax to Bx	C <sub>L</sub> = 50 pF R <sub>L</sub> = 500Ω		0.25	ns
t <sub>PZH</sub> t <sub>PZL</sub>	Bus Enable Time $\overline{\text{BE}}$ to Ax or Bx	C <sub>L</sub> = 50 pF R <sub>L</sub> = 500Ω	1.5	6.5	
t <sub>PHZ</sub> t <sub>PLZ</sub>	Bus Disable Time $\overline{\text{BE}}$ to Ax or Bx	R = 500Ω	1.5	5.5	

### Switching Characteristics over 2.5V Operating Range

Parameters	Description	Test Conditions	P13C32X245		Units
			Com.		
			Min	Max	
t <sub>PLH</sub> t <sub>PHL</sub>	Propagation Delay <sup>(2,3)</sup> Ax to Bx	C <sub>L</sub> = 50 pF R <sub>L</sub> = 500Ω		0.25	ns
t <sub>PZH</sub> t <sub>PZL</sub>	Bus Enable Time $\overline{\text{BE}}$ to Ax or Bx	C <sub>L</sub> = 50 pF R <sub>L</sub> = 500Ω	1.5	9.8	
t <sub>PHZ</sub> t <sub>PLZ</sub>	Bus Disable Time $\overline{\text{BE}}$ to Ax or Bx	R = 500Ω	1.5	8.3	

Notes:

1. See test circuit and waveforms.
2. This parameter is guaranteed but not tested on Propagation Delays.
3. The bus switch contributes no propagational delay other than the RC delay of the On-Resistance of the switch and the load capacitance. The time constant for the switch alone is of the order of 0.25 ns for 50 pF load. Since this time constant is much smaller than the rise/fall times of typical driving signals, it adds very little propagational delay to the system. Propagational delay of the bus switch when used in a system is determined by the driving circuit on the driving side of the switch and its interaction with the load on the driven side.

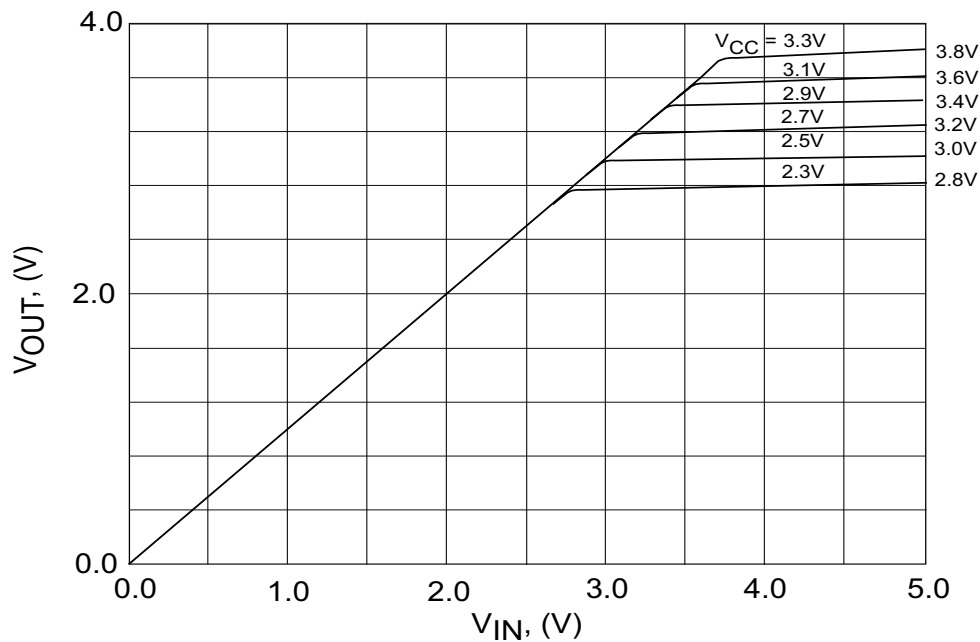

Output Voltage vs. Input Voltage over Various Supply Voltages

**Output Voltage vs. Input Voltage over Various Supply Voltages**

**Packaging Mechanical: 40-pin BQSOP (B)**

 DOCUMENT CONTROL NO.  
 PD - 1209

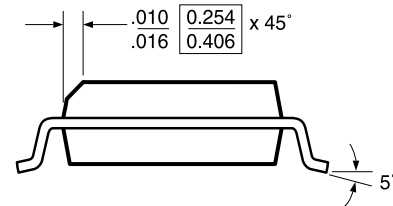
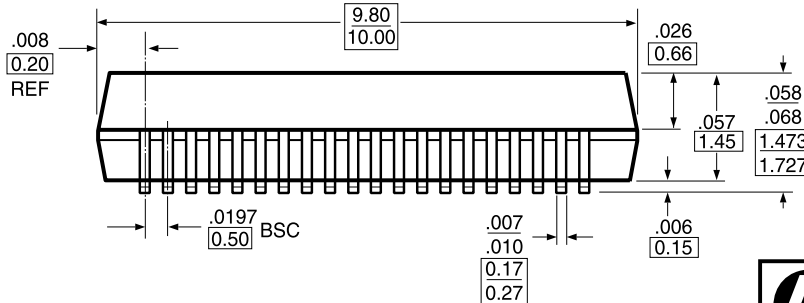
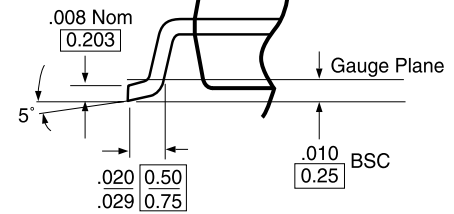
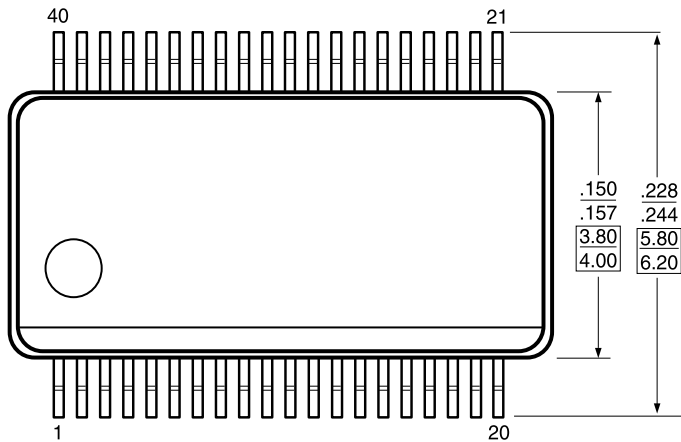
 REVISION: F  
 DATE: 03/09/05

X.XX	DENOTES DIMENSION IN MILLIMETERS
X.XX	

- Notes:
1. Controlling dimensions in millimeters
  2. Ref.: JEDEC MO - 154C/BB
  3. Package Outline Exclusive of Mold Flash and Metal Burr

 Pericom Semiconductor Corporation  
 3545 N. 1st Street, San Jose, CA 95134  
 1-800-435-2335 • www.pericom.com

**DESCRIPTION: 40-Pin, 150-Mil Wide BQSOP**
**PACKAGE CODE: B**
**Ordering Information**

Ordering Code	Package Code	Package Type
PI3C32X245BE	B	Pb-free & Green, 40-pin BQSOP

 1. Thermal characteristics can be found on the company web site at [www.pericom.com/packaging/](http://www.pericom.com/packaging/)