

Description

The AP3502 is a 340kHz fixed frequency, current mode, PWM synchronous buck (step-down) DC-DC converter, capable of driving a 2A load with high efficiency, excellent line and load regulation. The device integrates N-channel power MOSFET switches with low on-resistance. Current mode control provides fast transient response and cycle-by-cycle current limit.

The AP3502 employs complete protection to ensure system security, including output Over Voltage Protection, input Under Voltage Lock Out, programmable soft-start, and Over Temperature Protection.

This IC is available in SOIC-8 package.

Features

- Input Voltage Range: 4.5V to 18V
- Fixed 340kHz Frequency
- High Efficiency: up to 95%
- Output Current: 2A
- Current Mode Control
- Built-In Over Current Protection
- Built-In Thermal Shutdown Function
- Built-In UVLO Function
- Built-In Over Voltage Protection
- Programmable Soft-Start

Pin Assignments

(Top View)

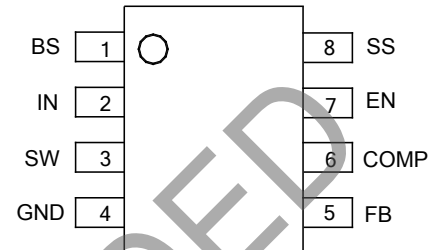

SOIC-8

Applications

- LCD TV
- Set Top Box
- Portable DVD
- Digital Photo Frame

NOT RECOMMENDED FOR NEW DESIGN

Typical Applications Circuit

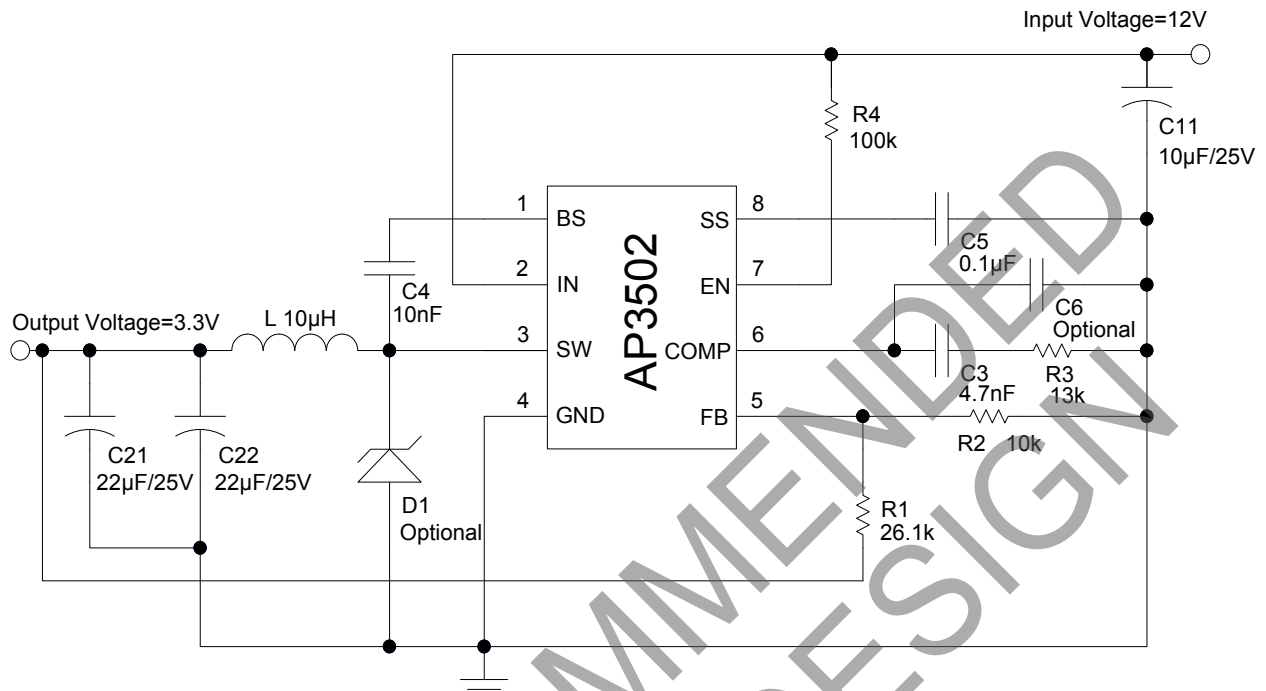

Pin Descriptions

Pin Number	Pin Name	Function
1	BS	Bootstrap pin. A bootstrap capacitor is connected between the BS pin and SW pin. The voltage across the bootstrap capacitor drives the internal high-side power MOSFET
2	IN	Supply power input pin. A capacitor should be connected between the IN pin and GND pin to keep the input voltage constant
3	SW	Power switch output pin. This pin is connected to the inductor and bootstrap capacitor
4	GND	Ground pin
5	FB	Feedback pin. This pin is connected to an external resistor divider to program the system output voltage. When the FB pin voltage exceeds 1.1V, the over voltage protection is triggered. When the FB pin voltage is below 0.3V, the oscillator frequency is lowered to realize short circuit protection
6	COMP	Compensation pin. This pin is the output of the transconductance error amplifier and the input to the current comparator. It is used to compensate the control loop. Connect a series RC network from this pin to GND. In some cases, an additional capacitor from this pin to GND pin is required
7	EN	Control input pin. EN is a digital input that turns the regulator on or off. Drive EN high/low to turn on/off the regulator. Pull up with 100kΩ resistor for automatic startup
8	SS	Soft-start control input pin. SS controls the soft-start period. Connect a capacitor from SS to GND to set the soft-start period. A 0.1µF capacitor sets the soft-start period to 15ms. To disable the soft-start feature, leave SS unconnected

Functional Block Diagram

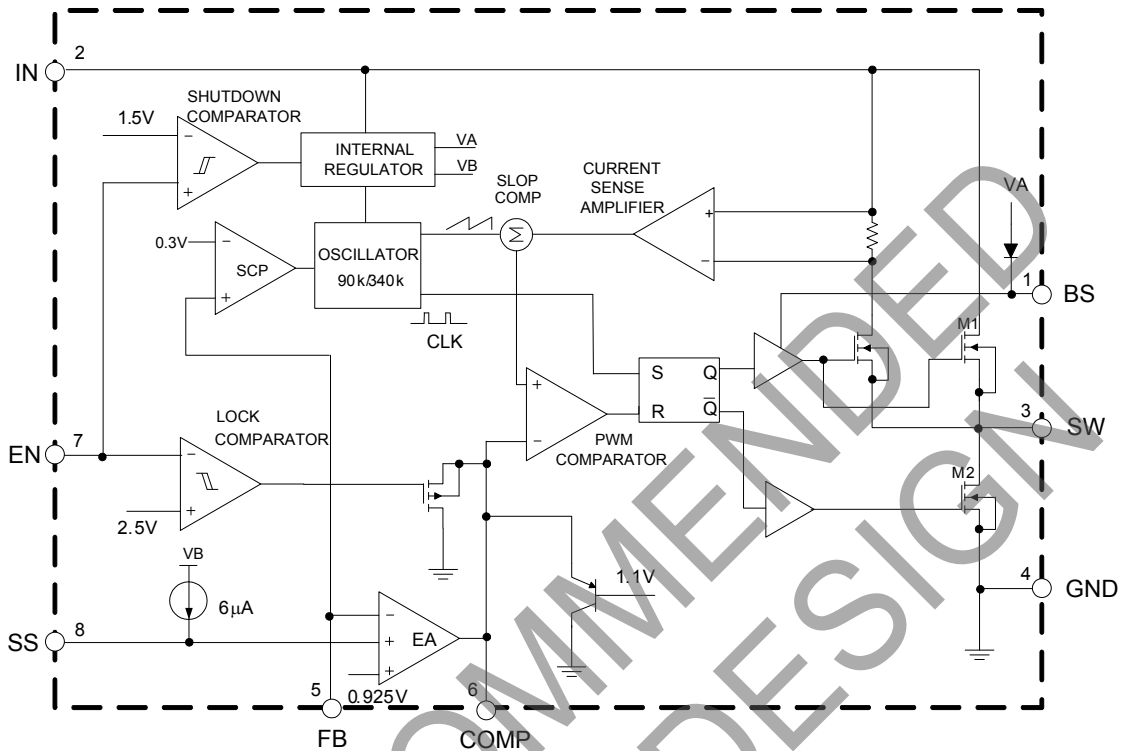

NOT RECOMMENDED FOR NEW DESIGN

Absolute Maximum Ratings (Note 1)

Symbol	Parameter	Value	Unit
V _{IN}	IN Pin Voltage	-0.3 to 20	V
V _{EN}	EN Pin Voltage	-0.3 to V _{IN}	V
V _{SW}	SW Pin Voltage	21	V
V _{BS}	BS Pin Voltage	-0.3 to V _{SW} +6	V
V _{FB}	FB Pin Voltage	-0.3 to 6	V
V _{COMP}	COMP Pin Voltage	-0.3 to 6	V
V _{SS}	SS Pin Voltage	-0.3 to 6	V
θ _{JA}	Thermal Resistance	105	°C/W
T _J	Operating Junction Temperature	+150	°C
T _{STG}	Storage Temperature	-65 to +150	°C
T _{LEAD}	Lead Temperature (Soldering, 10sec)	+260	°C
V _{HBM}	ESD (Human Body Model)	2000	V
V _{MM}	ESD (Machine Model)	200	V

Note 1: Stresses greater than those listed under "Absolute Maximum Ratings" can cause permanent damage to the device. These are stress ratings only, and functional operation of the device at these or any other conditions beyond those indicated under "Recommended Operating Conditions" is not implied. Exposure to "Absolute Maximum Ratings" for extended periods can affect device reliability.

Recommended Operating Conditions

Symbol	Parameter	Min	Max	Unit
V _{IN}	Input Voltage	4.5	18	V
T _A	Operating Ambient Temperature	-40	+85	°C

Electrical Characteristics ($T_A=+25^{\circ}\text{C}$, $V_{IN}=V_{EN}=12\text{V}$, $V_{OUT}=3.3\text{V}$, unless otherwise specified.)

Symbol	Parameter	Conditions	Min	Typ	Max	Unit
SUPPLY VOLTAGE (IN PIN)						
V_{IN}	Input Voltage	—	4.5	—	18	V
I_Q	Quiescent Current	$V_{FB}=1\text{V}, V_{EN}=3\text{V}$	—	1.2	1.4	mA
I_{SHDN}	Shutdown Supply Current	$V_{EN}=0\text{V}$	—	0.1	10	μA
UNDER VOLTAGE LOCKOUT						
V_{UVLO}	Input UVLO Threshold	V_{IN} Rising	3.65	4.00	4.25	V
V_{HYS}	Input UVLO Hysteresis	—	—	200	—	mV
ENABLE (EN PIN)						
—	EN Shutdown Threshold Voltage	—	1.1	1.5	2	V
—	EN Shutdown Threshold Voltage Hysteresis (Note 2)	—	—	350	—	mV
—	EN Lockout Threshold Voltage	—	2.2	2.5	2.7	V
—	EN Lockout Hysteresis	—	—	210	—	mV
VOLTAGE REFERENCE (FB PIN)						
V_{FB}	Feedback Voltage	—	0.907	0.925	0.943	V
V_{FBOV}	Feedback Over Voltage Threshold	—	—	1.1	—	V
I_{FB}	Feedback Bias Current	$V_{FB}=1\text{V}$	-0.1	—	0.1	μA
MOSFET						
R_{DSOH}	High-side Switch On-resistance(Note 3)	$I_{SW}=0.2\text{A}/0.7\text{A}$	—	100	—	$\text{m}\Omega$
R_{DSOL}	Low-side Switch On-resistance(Note 3)	$I_{SW}=-0.2\text{A}/-0.7\text{A}$	—	100	—	$\text{m}\Omega$
CURRENT LIMIT						
I_{LEAKH}	High-side Switch Leakage Current	$V_{IN}=18\text{V}, V_{EN}=V_{SW}=0\text{V}$	—	0.1	10	μA
I_{LIMH}	High-side Switch Current Limit	—	2.7	3.5	—	A
I_{LIML}	Low-side Switch Current Limit	From Drain to Source	—	1.4	—	A
SWITCHING REGULATOR						
f_{OSC1}	Oscillator Frequency	—	280	340	400	kHz
f_{OSC2}	Short Circuit Oscillator Frequency	—	—	90	—	kHz
D_{MAX}	Maximum Duty Cycle	$V_{FB}=0.85\text{V}$	—	90	—	%
D_{MIN}	Minimum Duty Cycle	$V_{FB}=1\text{V}$	—	—	0	%

Electrical Characteristics (continued. $T_A=+25^{\circ}\text{C}$, $V_{IN}=V_{EN}=12\text{V}$, $V_{OUT}=3.3\text{V}$, unless otherwise specified.)

Symbol	Parameter	Conditions	Min	Typ	Max	Unit
ERROR AMPLIFIER						
A_{EA}	Error Amplifier Voltage Gain (Note 2)	—	—	400	—	V/V
G_{EA}	Error Amplifier Transconductance	—	—	800	—	$\mu\text{A/V}$
G_{CS}	COMP to Current Sense Transconductance	—	—	3.5	—	A/V
THERMAL SHUTDOWN						
T_{OTSD}	Thermal Shutdown (Note 2)	—	—	+160	—	$^{\circ}\text{C}$
T_{HYS}	Thermal Shutdown Hysteresis (Note 2)	—	—	+30	—	$^{\circ}\text{C}$
SOFT START (SS PIN)						
t_{SS}	Soft-Start Time (Note 2)	$C_{SS}=0.1\mu\text{F}$	—	15	—	ms
—	Soft-Start Current	$V_{SS}=0\text{V}$	—	6	—	μA

Notes: 2. Not tested, guaranteed by design.

$$3. R_{DS(on)} = \frac{V_{SW1} - V_{SW2}}{I_{SW1} - I_{SW2}}$$

NOT RECOMMENDED FOR NEW DESIGN

Performance Characteristics ($T_A=+25^\circ\text{C}$, $V_{IN}=12\text{V}$, $V_{OUT}=3.3\text{V}$, unless otherwise noted.)

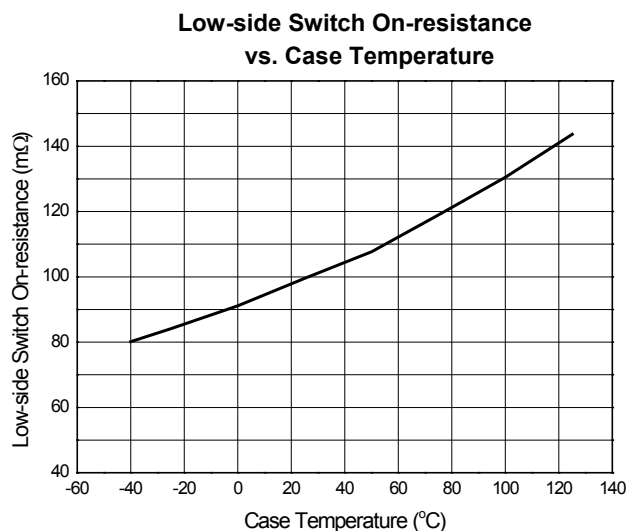
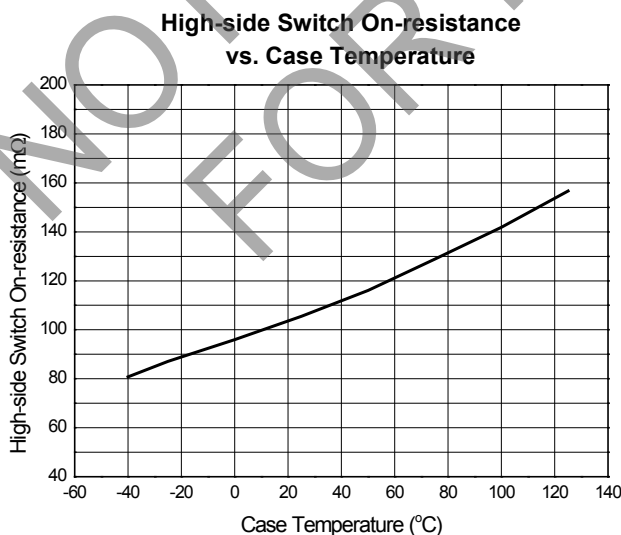
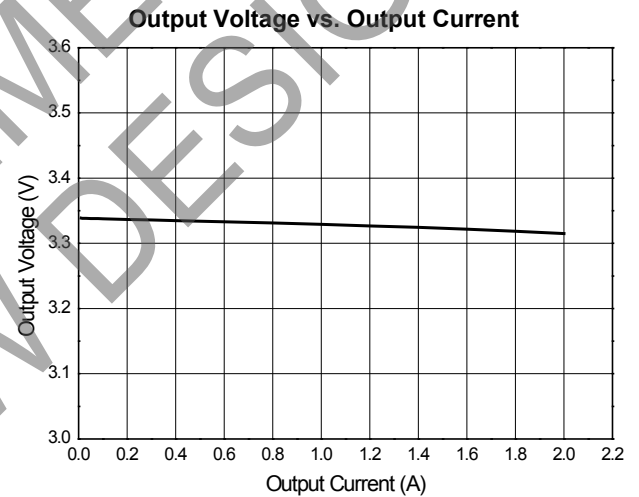
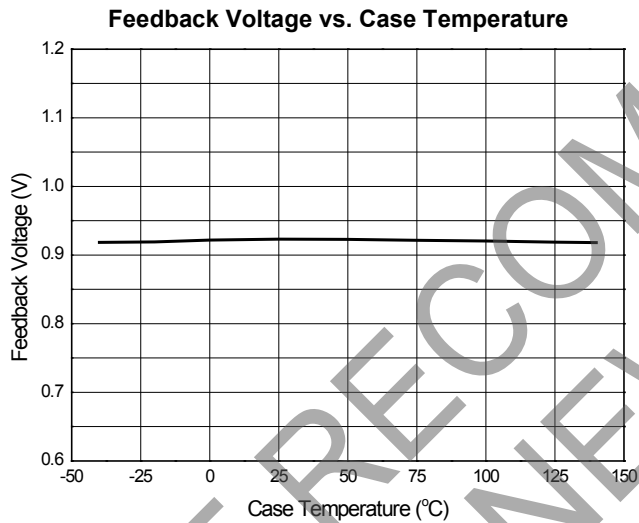
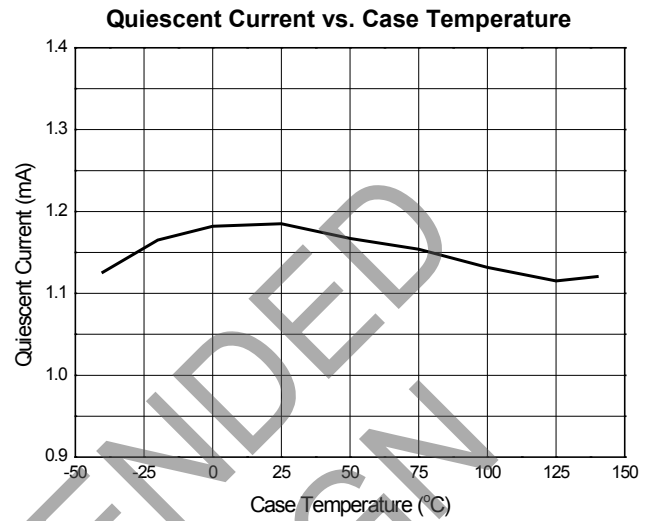
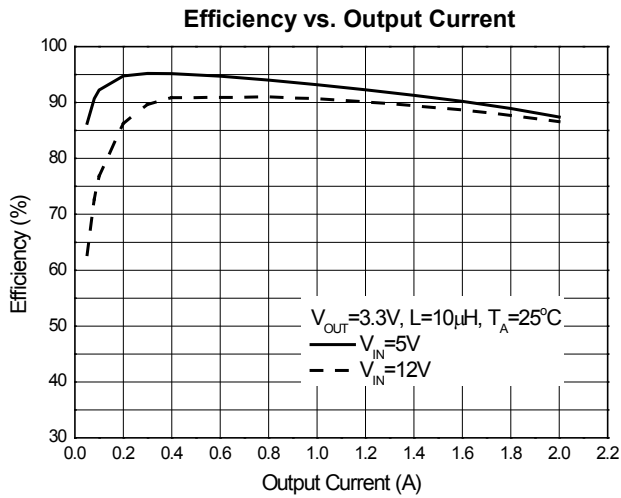

Performance Characteristics (continued) ($T_A=+25^{\circ}\text{C}$, $V_{IN}=12\text{V}$, $V_{OUT}=3.3\text{V}$, unless otherwise noted.)

Output Ripple ($I_{OUT}=2\text{A}$)

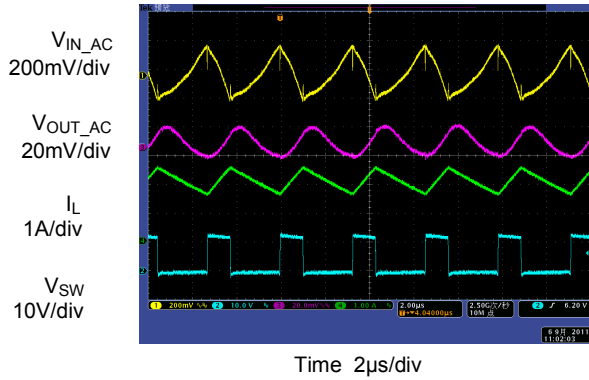

Load Transient ($I_{OUT} = 1\text{A to } 2\text{A}$)

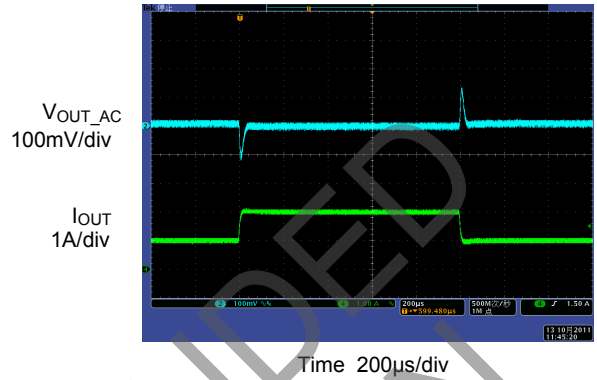

Enable Turn on Characteristic
($V_{IN}=12\text{V}$, $V_{EN}=3.3\text{V}$, $V_{OUT}=3.3\text{V}$, $I_L=2\text{A}$)

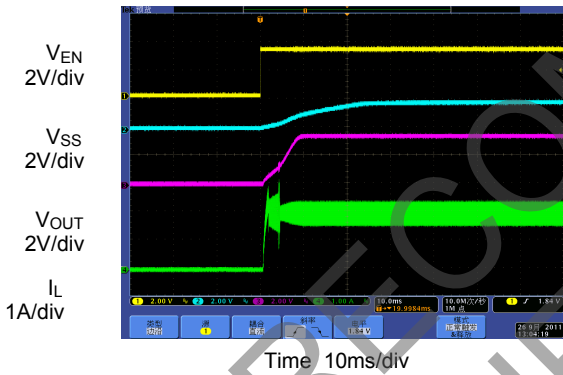

Enable Turn off Characteristic
($V_{IN}=12\text{V}$, $V_{EN}=3.3\text{V}$, $V_{OUT}=3.3\text{V}$, $I_L=2\text{A}$)

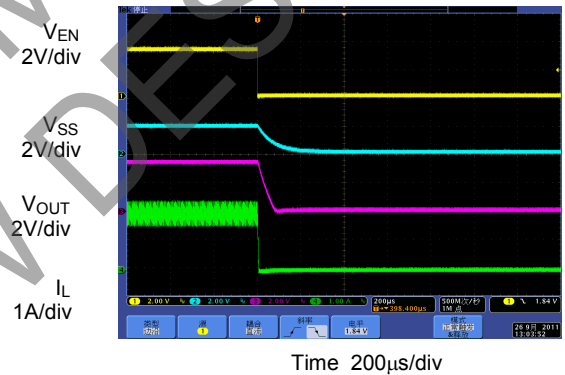

Short Circuit Protection ($I_{OUT}=0\text{A}$)

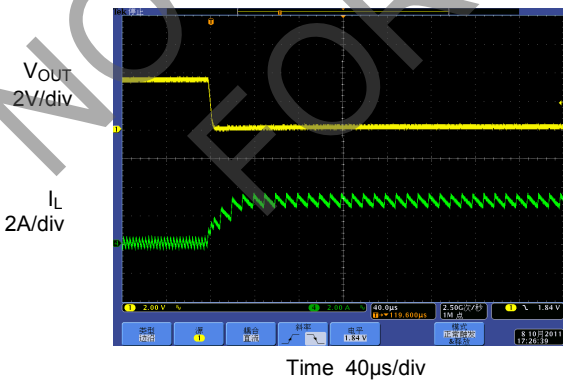

Short Circuit Recovery ($I_{OUT}=0\text{A}$)

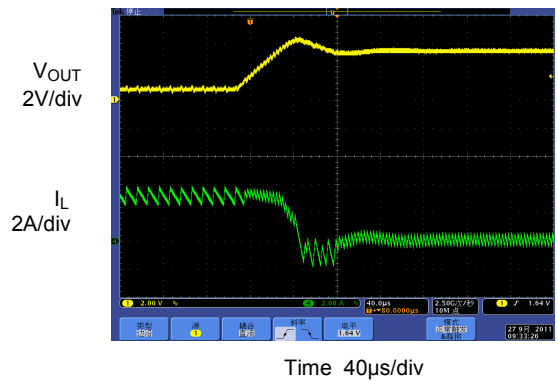

Ordering Information

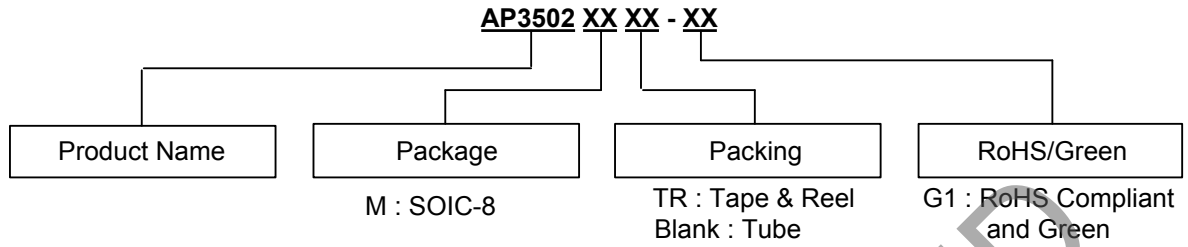

Package	Temperature Range	Part Number	Marking ID	Packing
SOIC-8	-40 to +85°C	AP3502M-G1	3502M-G1	Tube
		AP3502MTR-G1	3502M-G1	Tape & Reel

NOT RECOMMENDED FOR NEW DESIGN

Package Outline Dimensions (All dimensions in mm(inch).)

Please see <http://www.diodes.com/package-outlines.html> for the latest version.

(1) Package Type: SOIC-8

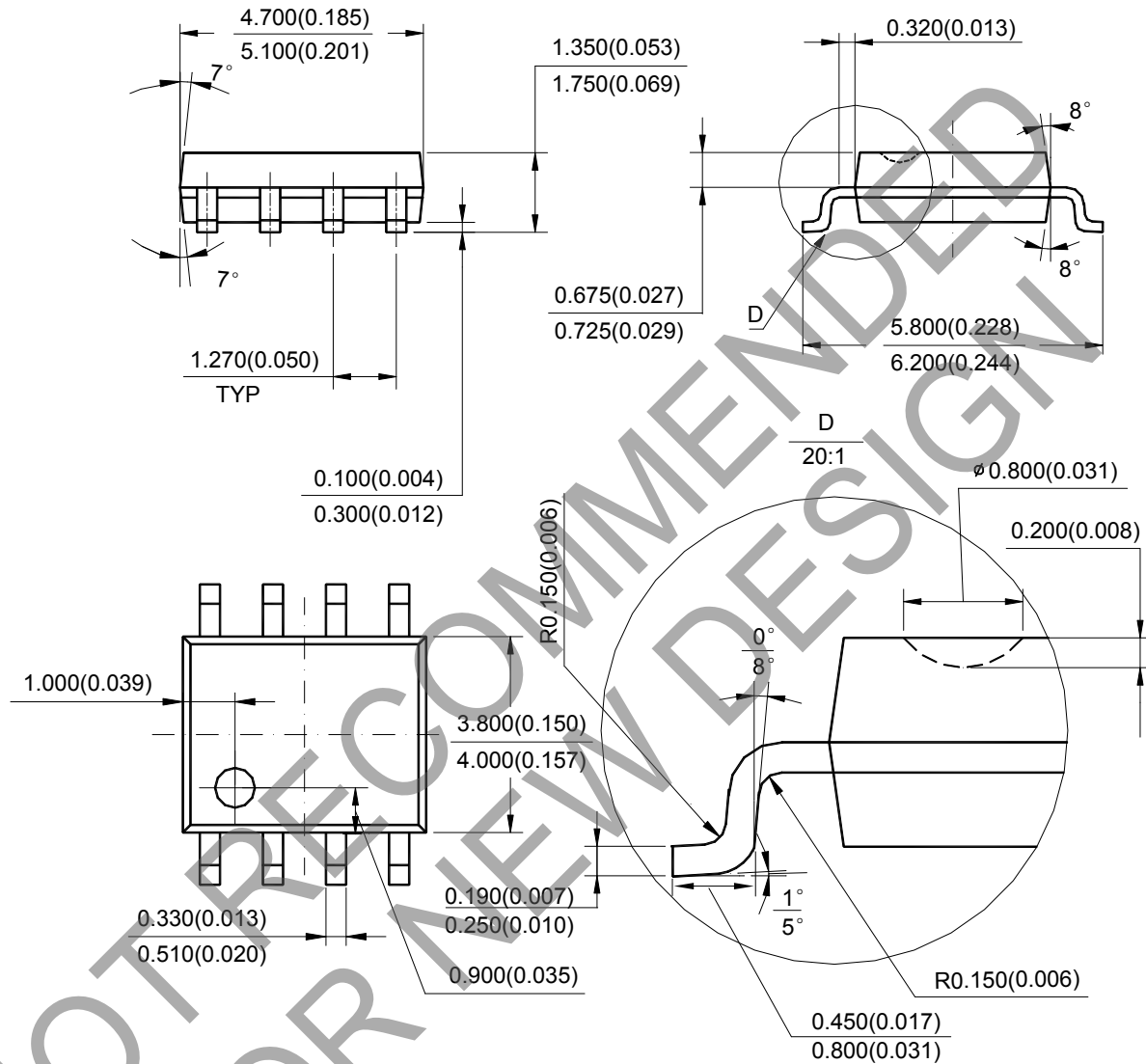

Note: Eject hole, oriented hole and mold mark is optional.

IMPORTANT NOTICE

DIODES INCORPORATED MAKES NO WARRANTY OF ANY KIND, EXPRESS OR IMPLIED, WITH REGARDS TO THIS DOCUMENT, INCLUDING, BUT NOT LIMITED TO, THE IMPLIED WARRANTIES OF MERCHANTABILITY AND FITNESS FOR A PARTICULAR PURPOSE (AND THEIR EQUIVALENTS UNDER THE LAWS OF ANY JURISDICTION).

Diodes Incorporated and its subsidiaries reserve the right to make modifications, enhancements, improvements, corrections or other changes without further notice to this document and any product described herein. Diodes Incorporated does not assume any liability arising out of the application or use of this document or any product described herein; neither does Diodes Incorporated convey any license under its patent or trademark rights, nor the rights of others. Any Customer or user of this document or products described herein in such applications shall assume all risks of such use and will agree to hold Diodes Incorporated and all the companies whose products are represented on Diodes Incorporated website, harmless against all damages.

Diodes Incorporated does not warrant or accept any liability whatsoever in respect of any products purchased through unauthorized sales channel. Should Customers purchase or use Diodes Incorporated products for any unintended or unauthorized application, Customers shall indemnify and hold Diodes Incorporated and its representatives harmless against all claims, damages, expenses, and attorney fees arising out of, directly or indirectly, any claim of personal injury or death associated with such unintended or unauthorized application.

Products described herein may be covered by one or more United States, international or foreign patents pending. Product names and markings noted herein may also be covered by one or more United States, international or foreign trademarks.

This document is written in English but may be translated into multiple languages for reference. Only the English version of this document is the final and determinative format released by Diodes Incorporated.

LIFE SUPPORT

Diodes Incorporated products are specifically not authorized for use as critical components in life support devices or systems without the express written approval of the Chief Executive Officer of Diodes Incorporated. As used herein:

A. Life support devices or systems are devices or systems which:

1. are intended to implant into the body, or
2. support or sustain life and whose failure to perform when properly used in accordance with instructions for use provided in the labeling can be reasonably expected to result in significant injury to the user.

B. A critical component is any component in a life support device or system whose failure to perform can be reasonably expected to cause the failure of the life support device or to affect its safety or effectiveness.

Customers represent that they have all necessary expertise in the safety and regulatory ramifications of their life support devices or systems, and acknowledge and agree that they are solely responsible for all legal, regulatory and safety-related requirements concerning their products and any use of Diodes Incorporated products in such safety-critical, life support devices or systems, notwithstanding any devices- or systems-related information or support that may be provided by Diodes Incorporated. Further, Customers must fully indemnify Diodes Incorporated and its representatives against any damages arising out of the use of Diodes Incorporated products in such safety-critical, life support devices or systems.

Copyright © 2020, Diodes Incorporated

www.diodes.com