

## SIPMOS<sup>®</sup> Power-Transistor

### Features

- P-Channel
- Enhancement mode
- Avalanche rated
- dv/dt rated
- 175°C operating temperature

### Product Summary

Drain source voltage	$V_{DS}$	-60	V
Drain-source on-state resistance	$R_{DS(on)}$	0.023	$\Omega$
Continuous drain current	$I_D$	-80	A

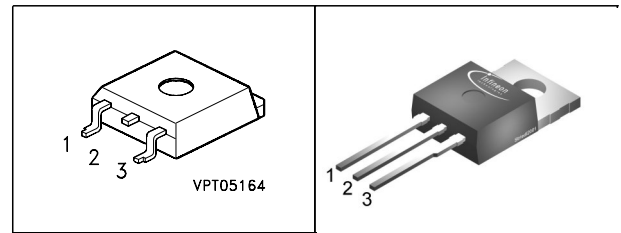

Type	Package	Lead free
SPP80P06P G	PG-TO220-3	Yes
SPB80P06P G	PG-TO263-3	Yes

Pin 1	PIN 2/4	PIN 3
G	D	S

**Maximum Ratings**, at  $T_j = 25\text{ °C}$ , unless otherwise specified

Parameter	Symbol	Value	Unit
Continuous drain current $T_C = 25\text{ °C}$ , 1) $T_C = 100\text{ °C}$	$I_D$	-80 -64	A
Pulsed drain current $T_C = 25\text{ °C}$	$I_D \text{ puls}$	-320	
Avalanche energy, single pulse $I_D = -80\text{ A}$ , $V_{DD} = -25\text{ V}$ , $R_{GS} = 25\text{ }\Omega$	$E_{AS}$	823	mJ
Avalanche energy, periodic limited by $T_{jmax}$	$E_{AR}$	34	
Reverse diode dv/dt $I_S = -80\text{ A}$ , $V_{DS} = -48$ , $di/dt = 200\text{ A}/\mu\text{s}$ , $T_{jmax} = 175\text{ °C}$	dv/dt	6	kV/ $\mu\text{s}$
Gate source voltage	$V_{GS}$	$\pm 20$	V
Power dissipation $T_C = 25\text{ °C}$	$P_{tot}$	340	W
Operating and storage temperature	$T_j, T_{stg}$	-55...+175	$^{\circ}\text{C}$
IEC climatic category; DIN IEC 68-1		55/175/56	

<sup>1</sup>Current limited by bondwire; with an  $R_{thJC} = 0.4\text{ K/W}$  the chip is able to carry  $I_D = -91\text{ A}$

**Thermal Characteristics**

Parameter	Symbol	Values			Unit
		min.	typ.	max.	
<b>Characteristics</b>					
Thermal resistance, junction - case	$R_{thJC}$	-	-	0.4	K/W
Thermal resistance, junction - ambient, leaded	$R_{thJA}$	-	-	62	
SMD version, device on PCB:	$R_{thJA}$				
@ min. footprint		-	-	62	
@ 6 cm <sup>2</sup> cooling area <sup>1)</sup>		-	-	40	

**Electrical Characteristics, at  $T_j = 25\text{ °C}$ , unless otherwise specified**

Parameter	Symbol	Values			Unit
		min.	typ.	max.	
<b>Static Characteristics</b>					
Drain- source breakdown voltage $V_{GS} = 0\text{ V}$ , $I_D = -250\text{ }\mu\text{A}$	$V_{(BR)DSS}$	-60	-	-	V
Gate threshold voltage, $V_{GS} = V_{DS}$ $I_D = -5.5\text{ mA}$	$V_{GS(th)}$	-2.1	-3	-4	
Zero gate voltage drain current $V_{DS} = -60\text{ V}$ , $V_{GS} = 0\text{ V}$ , $T_j = 25\text{ °C}$ $V_{DS} = -60\text{ V}$ , $V_{GS} = 0\text{ V}$ , $T_j = 150\text{ °C}$	$I_{DSS}$	-	-0.1	-1	$\mu\text{A}$
Gate-source leakage current $V_{GS} = -20\text{ V}$ , $V_{DS} = 0\text{ V}$	$I_{GSS}$	-	-10	-100	
Drain-source on-state resistance $V_{GS} = -10\text{ V}$ , $I_D = -64\text{ A}$	$R_{DS(on)}$	-	0.021	0.023	$\Omega$

<sup>1</sup>Device on 40mm\*40mm\*1.5mm epoxy PCB FR4 with 6cm<sup>2</sup> (one layer, 70  $\mu\text{m}$  thick) copper area for drain connection. PCB is vertical without blown air.

**Electrical Characteristics, at  $T_j = 25\text{ °C}$ , unless otherwise specified**

Parameter	Symbol	Values			Unit
		min.	typ.	max.	
<b>Dynamic Characteristics</b>					
Transconductance $V_{DS} \geq 2 \cdot I_D \cdot R_{DS(on)max}$ , $I_D = -64\text{ A}$	$g_{fs}$	18	36	-	S
Input capacitance $V_{GS} = 0\text{ V}$ , $V_{DS} = -25\text{ V}$ , $f = 1\text{ MHz}$	$C_{iss}$	-	4026	5033	pF
Output capacitance $V_{GS} = 0\text{ V}$ , $V_{DS} = -25\text{ V}$ , $f = 1\text{ MHz}$	$C_{oss}$	-	1252	1565	
Reverse transfer capacitance $V_{GS} = 0\text{ V}$ , $V_{DS} = -25\text{ V}$ , $f = 1\text{ MHz}$	$C_{rss}$	-	437	546	
Turn-on delay time $V_{DD} = -30\text{ V}$ , $V_{GS} = -10\text{ V}$ , $I_D = -64\text{ A}$ , $R_G = 1\ \Omega$	$t_{d(on)}$	-	24	36	ns
Rise time $V_{DD} = -30\text{ V}$ , $V_{GS} = -10\text{ V}$ , $I_D = -64\text{ A}$ , $R_G = 1\ \Omega$	$t_r$	-	18	27	
Turn-off delay time $V_{DD} = -30\text{ V}$ , $V_{GS} = -10\text{ V}$ , $I_D = -64\text{ A}$ , $R_G = 1\ \Omega$	$t_{d(off)}$	-	56	84	
Fall time $V_{DD} = -30\text{ V}$ , $V_{GS} = -10\text{ V}$ , $I_D = -64\text{ A}$ , $R_G = 1\ \Omega$	$t_f$	-	30	45	

**Electrical Characteristics, at  $T_j = 25\text{ °C}$ , unless otherwise specified**

Parameter	Symbol	Values			Unit
		min.	typ.	max.	
<b>Dynamic Characteristics</b>					
Gate to source charge $V_{DD} = -48\text{ V}, I_D = -80\text{ A}$	$Q_{gs}$	-	27.4	41	nC
Gate to drain charge $V_{DD} = -48\text{ V}, I_D = -80\text{ A}$	$Q_{gd}$	-	50	75	
Gate charge total $V_{DD} = -48\text{ V}, I_D = -80\text{ A}, V_{GS} = 0\text{ to }-10\text{ V}$	$Q_g$	-	115	173	
Gate plateau voltage $V_{DD} = -48\text{ V}, I_D = -80\text{ A}$	$V_{(plateau)}$	-	-6.2	-	V

Parameter	Symbol	Values			Unit
		min.	typ.	max.	
<b>Reverse Diode</b>					
Inverse diode continuous forward current $T_C = 25\text{ °C}$	$I_S$	-	-	-80	A
Inverse diode direct current, pulsed $T_C = 25\text{ °C}$	$I_{SM}$	-	-	-320	
Inverse diode forward voltage $V_{GS} = 0\text{ V}, I_F = -80\text{ A}$	$V_{SD}$	-	-1.2	-1.6	V
Reverse recovery time $V_R = -30\text{ V}, I_F = I_S, di_F/dt = 100\text{ A}/\mu\text{s}$	$t_{rr}$	-	117	175	ns
Reverse recovery charge $V_R = -30\text{ V}, I_F = I_S, di_F/dt = 100\text{ A}/\mu\text{s}$	$Q_{rr}$	-	420	630	nC

**Power dissipation**

$$P_{\text{tot}} = f(T_C)$$

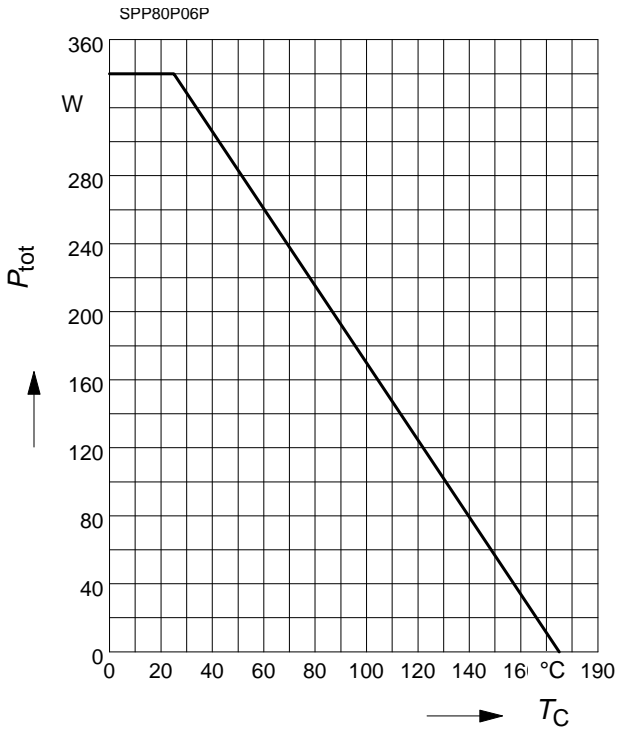

**Drain current**

$$I_D = f(T_C)$$

parameter:  $V_{GS} \geq 10 \text{ V}$

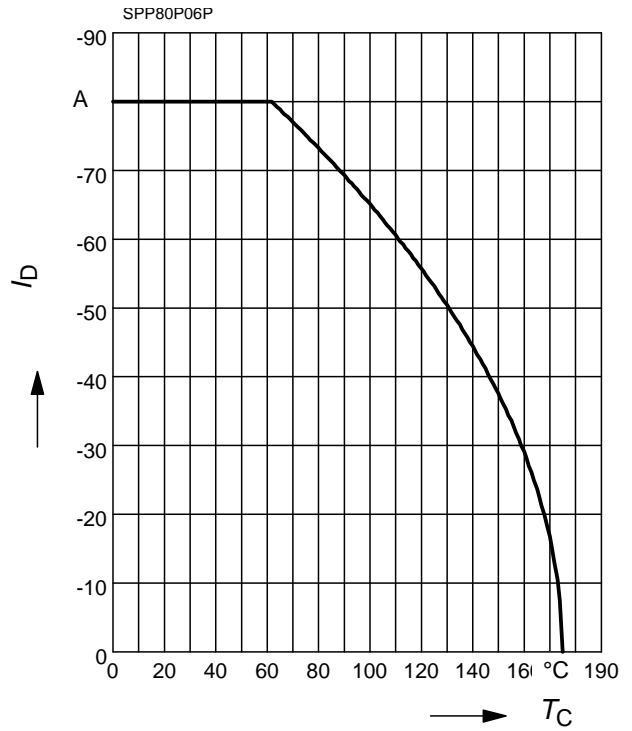

**Safe operating area**

$$I_D = f(V_{DS})$$

parameter:  $D = 0$ ,  $T_C = 25 \text{ °C}$

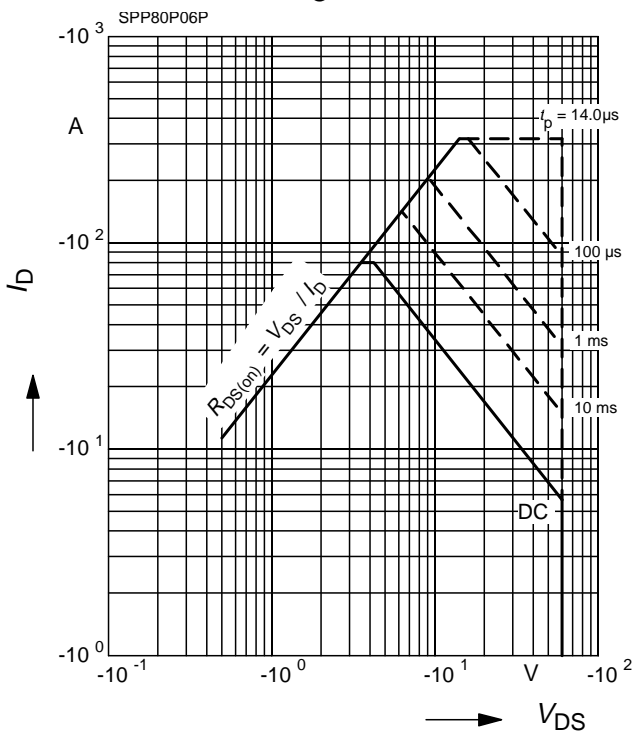

**Transient thermal impedance**

$$Z_{\text{thJC}} = f(t_p)$$

parameter:  $D = t_p/T$

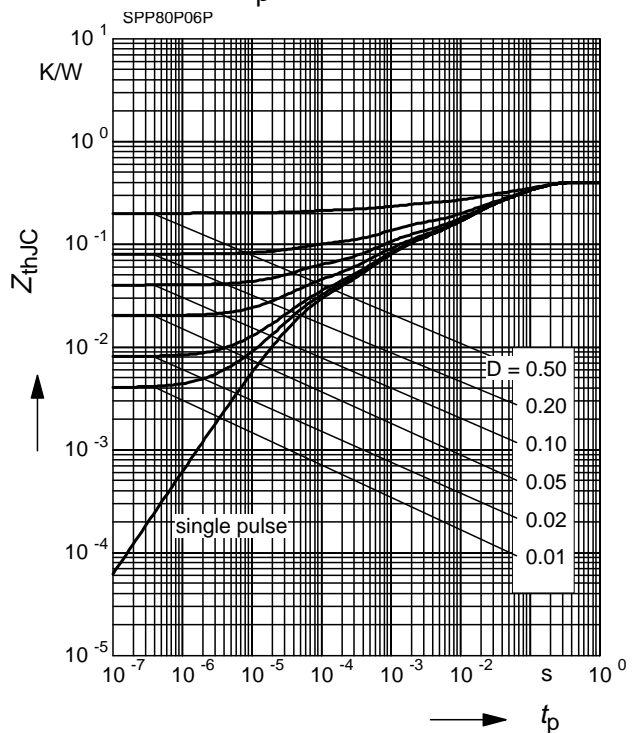

**Typ. output characteristic**

$I_D = f(V_{DS}); T_j = 25^\circ\text{C}$

parameter:  $t_p = 80 \mu\text{s}$

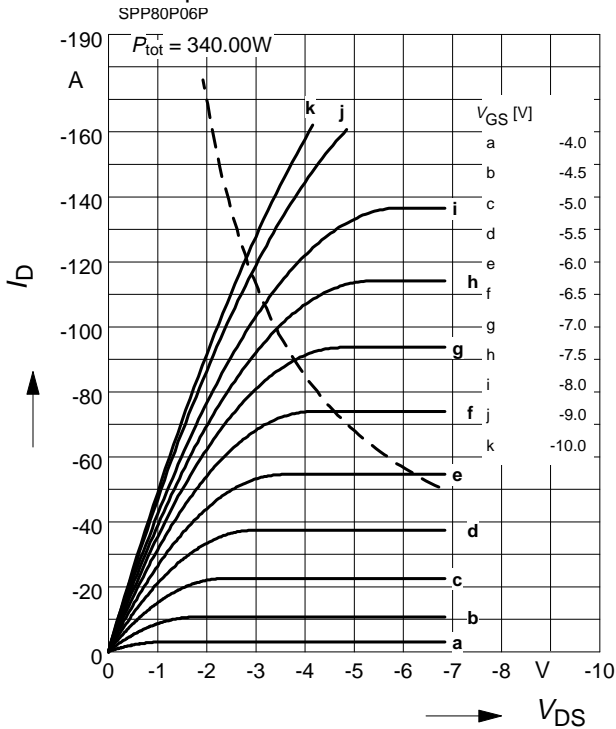

**Typ. drain-source-on-resistance**

$R_{DS(on)} = f(I_D)$

parameter:  $V_{GS}$

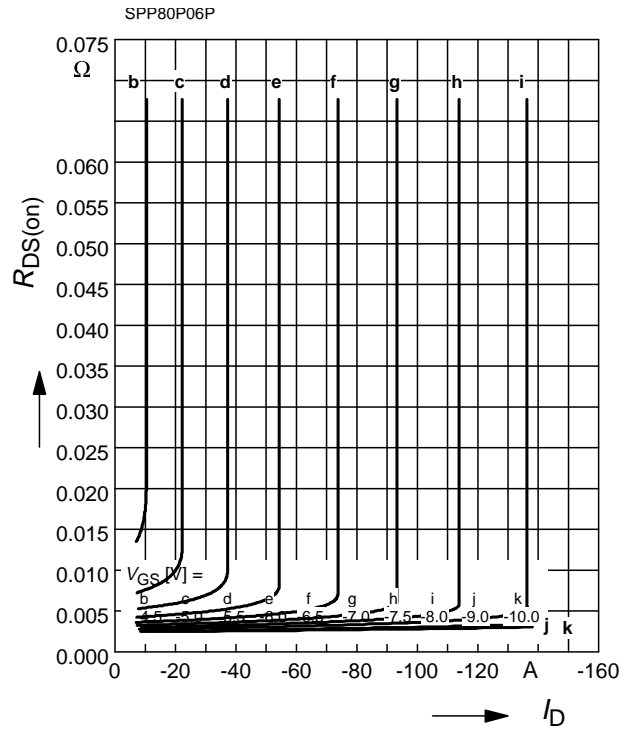

**Typ. transfer characteristics  $I_D = f(V_{GS})$**

$V_{DS} \geq 2 \times I_D \times R_{DS(on)max}$

parameter:  $t_p = 80 \mu\text{s}$

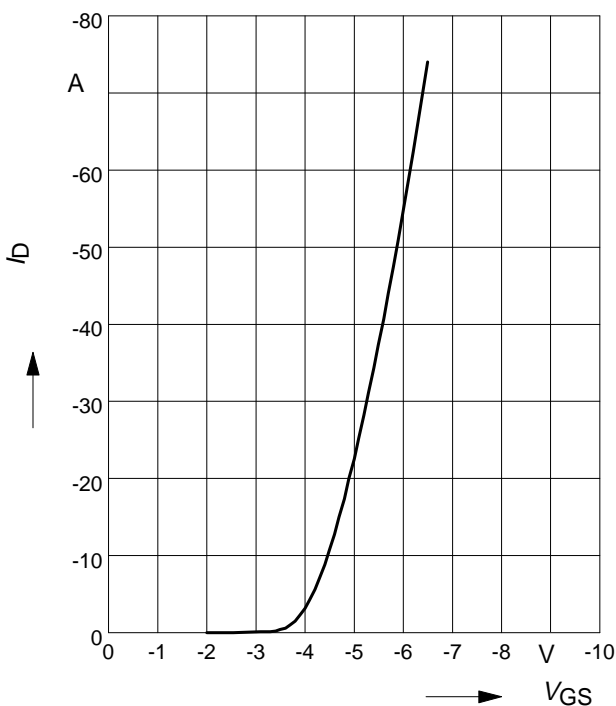

**Typ. forward transconductance**

$g_{fs} = f(I_D); T_j = 25^\circ\text{C}$

parameter:  $g_{fs}$

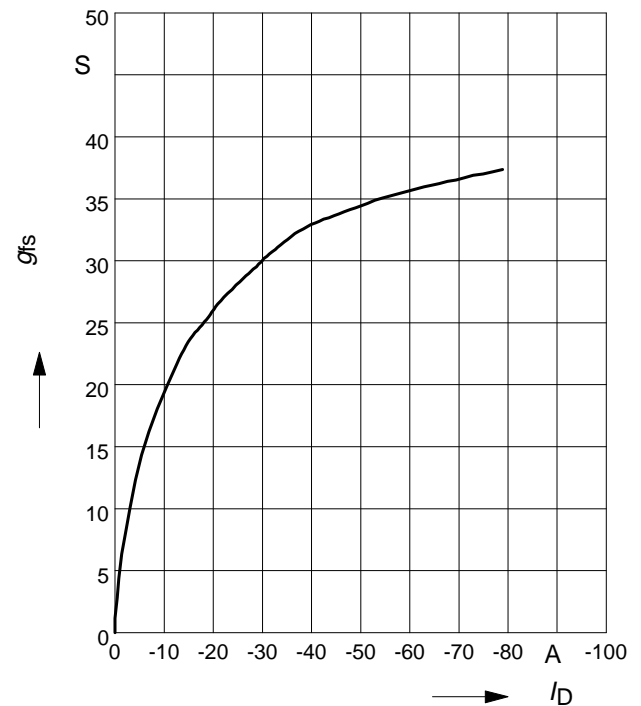

**Drain-source on-state resistance**

$$R_{DS(on)} = f(T_j)$$

parameter:  $I_D = -64\text{ A}$ ,  $V_{GS} = -10\text{ V}$

SPP80P06P

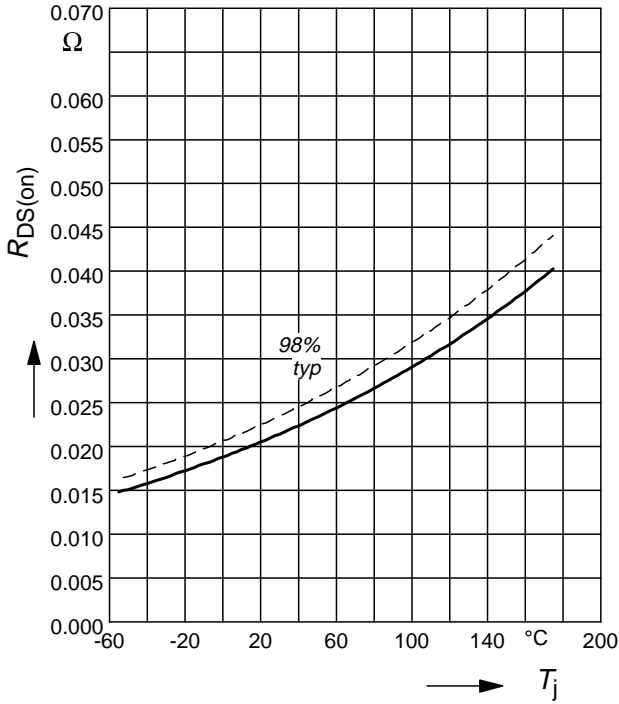

**Gate threshold voltage**

$$V_{GS(th)} = f(T_j)$$

parameter:  $V_{GS} = V_{DS}$ ,  $I_D = -5.5\text{ mA}$

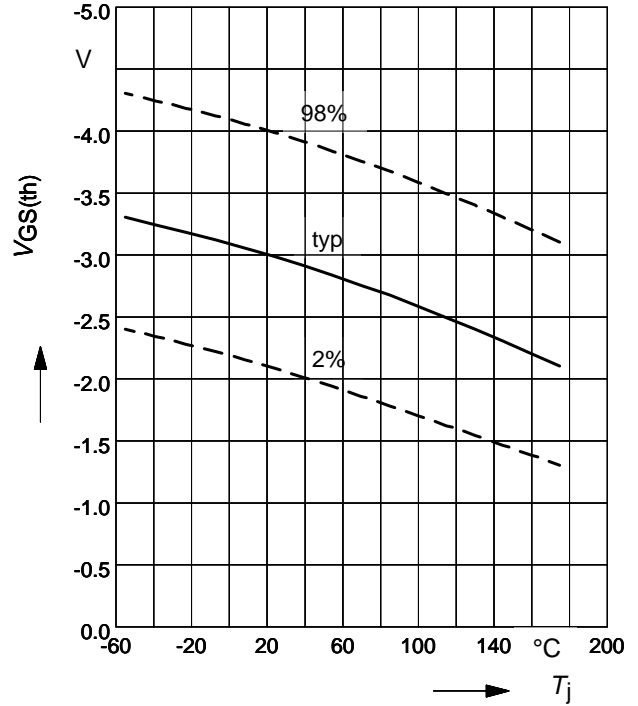

**Typ. capacitances**

$$C = f(V_{DS})$$

parameter:  $V_{GS}=0\text{V}$ ,  $f=1\text{ MHz}$

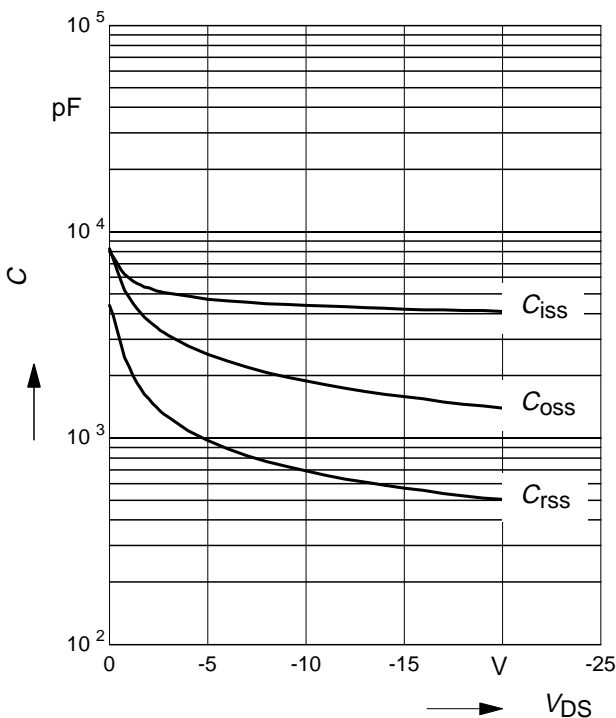

**Forward characteristics of reverse diode**

$$I_F = f(V_{SD})$$

parameter:  $T_j$ ,  $t_p = 80\text{ }\mu\text{s}$

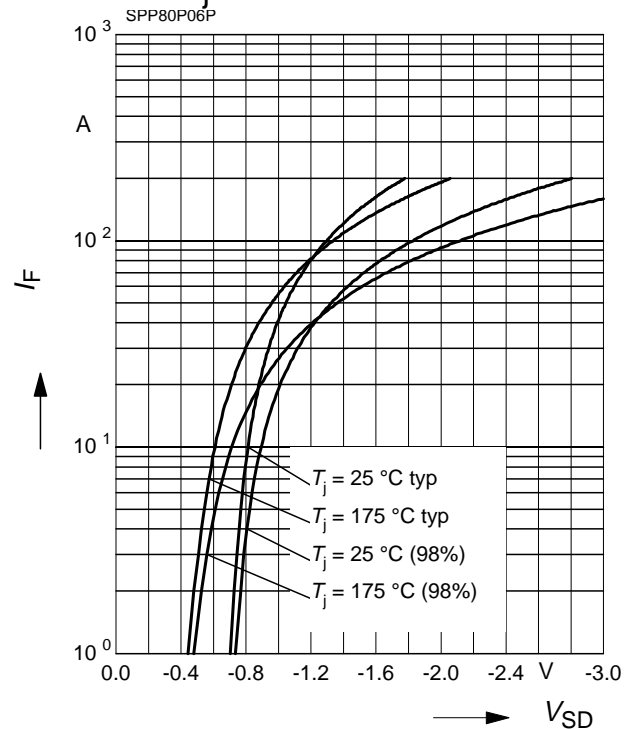

**Avalanche energy**

$$E_{AS} = f(T_j)$$

para.:  $I_D = -80\text{ A}$  ,  $V_{DD} = -25\text{ V}$  ,  $R_{GS} = 25\ \Omega$

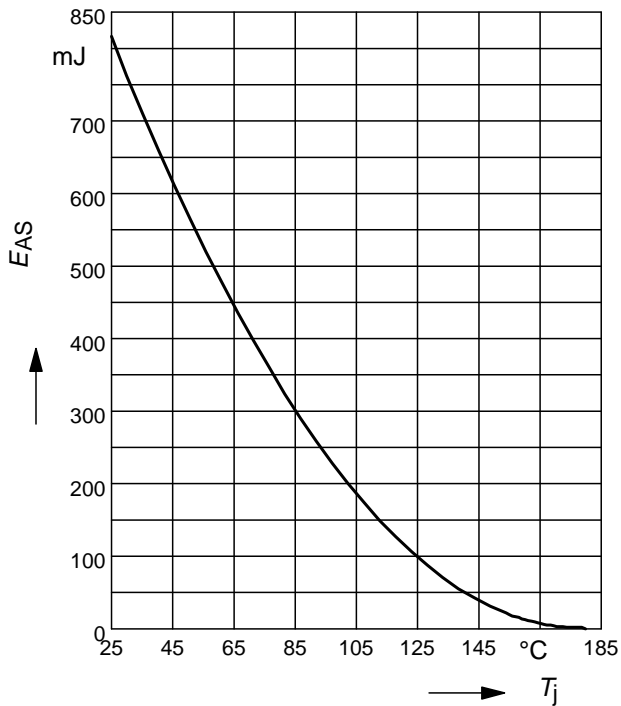

**Typ. gate charge**

$$V_{GS} = f(Q_{Gate})$$

parameter:  $I_D = -80\text{ A}$  pulsed

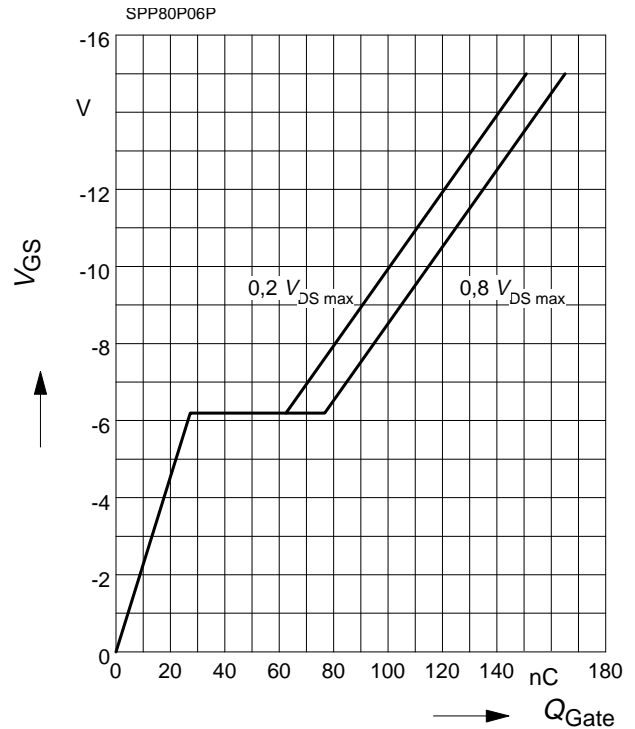

**Drain-source breakdown voltage**

$$V_{(BR)DSS} = f(T_j)$$

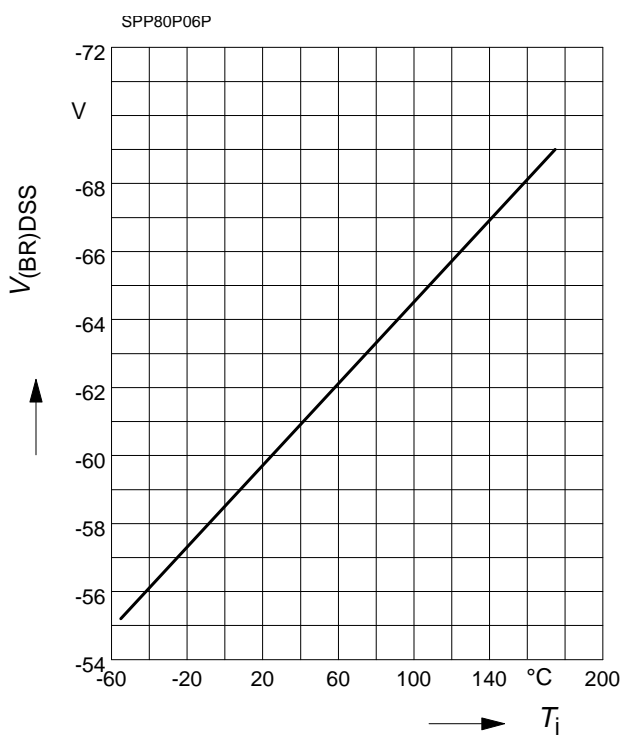



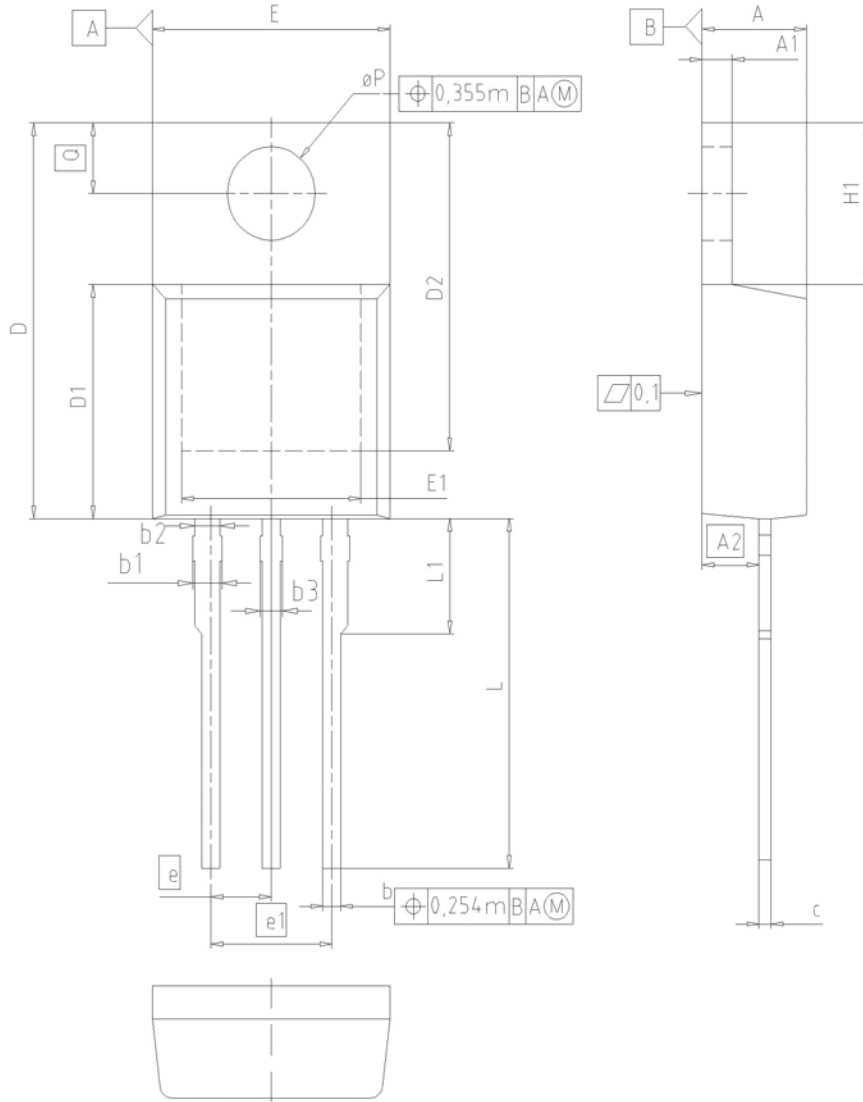

DIM	MILLIMETERS		INCHES	
	MIN	MAX	MIN	MAX
A	4.30	4.57	0.169	0.180
A1	1.17	1.40	0.046	0.055
A2	2.15	2.72	0.085	0.107
b	0.65	0.86	0.026	0.034
b1	0.95	1.40	0.037	0.055
b2	0.95	1.15	0.037	0.045
b3	0.65	1.15	0.026	0.045
c	0.33	0.60	0.013	0.024
D	14.81	15.95	0.583	0.628
D1	8.51	9.45	0.335	0.372
D2	12.19	13.10	0.480	0.516
E	9.70	10.36	0.382	0.408
E1	6.50	8.60	0.256	0.339
e	2.54		0.100	
e1	5.08		0.200	
N	3		3	
H1	5.90	6.90	0.232	0.272
L	13.00	14.00	0.512	0.551
L1	-	4.80	-	0.189
$\phi P$	3.60	3.89	0.142	0.153
Q	2.60	3.00	0.102	0.118

**DOCUMENT NO.**  
Z8B00003318

**SCALE**

**EUROPEAN PROJECTION**

**ISSUE DATE**  
23-08-2007

**REVISION**  
05

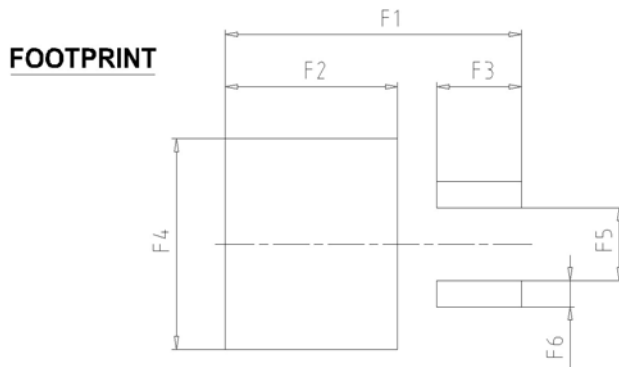
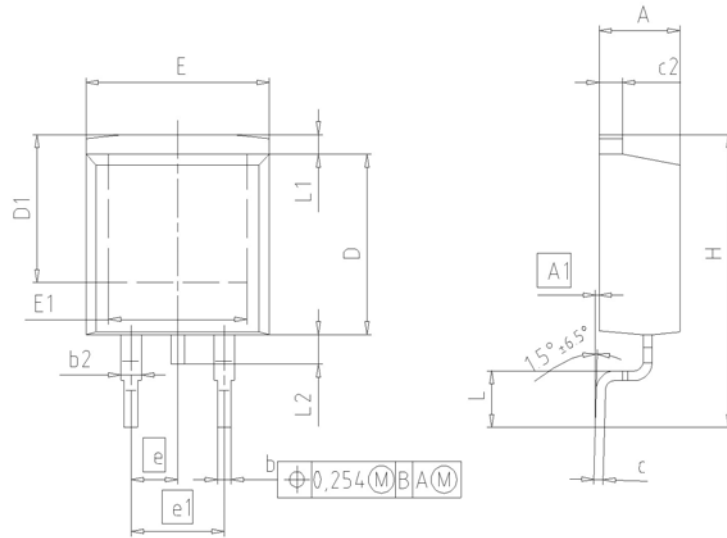

DIM	MILLIMETERS		INCHES	
	MIN	MAX	MIN	MAX
A	4.30	4.57	0.169	0.180
A1	0.00	0.25	0.000	0.010
b	0.65	0.85	0.026	0.033
b2	0.95	1.15	0.037	0.045
c	0.33	0.65	0.013	0.026
c2	1.17	1.40	0.046	0.055
D	8.51	9.45	0.335	0.372
D1	7.10	7.90	0.280	0.311
E	9.80	10.31	0.386	0.406
E1	6.50	8.60	0.256	0.339
e	2.54		0.100	
e1	5.08		0.200	
N	2		2	
H	14.61	15.88	0.575	0.625
L	2.29	3.00	0.090	0.118
L1	0.70	1.60	0.028	0.063
L2	1.00	1.78	0.039	0.070
F1	16.05	16.25	0.632	0.640
F2	9.30	9.50	0.366	0.374
F3	4.50	4.70	0.177	0.185
F4	10.70	10.90	0.421	0.429
F5	3.65	3.85	0.144	0.152
F6	1.25	1.45	0.049	0.057

**DOCUMENT NO.**  
Z8B00003324

**SCALE**

**EUROPEAN PROJECTION**

**ISSUE DATE**  
30-08-2007

**REVISION**  
01

**Published by**  
**Infineon Technologies AG**  
**81726 Munich, Germany**  
**© 2008 Infineon Technologies AG**  
**All Rights Reserved.**

**Legal Disclaimer**

The information given in this document shall in no event be regarded as a guarantee of conditions or characteristics. With respect to any examples or hints given herein, any typical values stated herein and/or any information regarding the application of the device, Infineon Technologies hereby disclaims any and all warranties and liabilities of any kind, including without limitation, warranties of non-infringement of intellectual property rights of any third party.

**Information**

For further information on technology, delivery terms and conditions and prices, please contact the nearest Infineon Technologies Office ([www.infineon.com](http://www.infineon.com)).

**Warnings**

Due to technical requirements, components may contain dangerous substances. For information on the types in question, please contact the nearest Infineon Technologies Office. Infineon Technologies components may be used in life-support devices or systems only with the express written approval of Infineon Technologies, if a failure of such components can reasonably be expected to cause the failure of that life-support device or system or to affect the safety or effectiveness of that device or system. Life support devices or systems are intended to be implanted in the human body or to support and/or maintain and sustain and/or protect human life. If they fail, it is reasonable to assume that the health of the user or other persons may be endangered.