

HEXFET® Power MOSFET

V_{DS}	20	V
V_{GS}	±12	V
$R_{DS(on) max}$ (@ $V_{GS} = 4.5V$)	11.7	mΩ
$R_{DS(on) max}$ (@ $V_{GS} = 2.5V$)	15.5	mΩ
I_D (@ $T_{C(Bottom)} = 25°C$)	12 Ⓢ	A

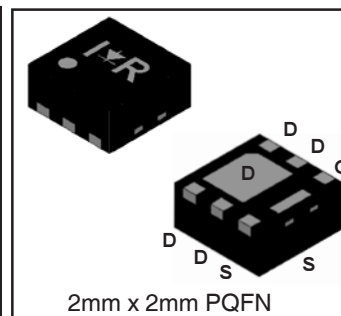
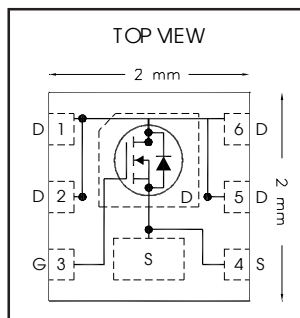

Applications

- Charge and discharge switch for battery application
- System/Load Switch

Features and Benefits

Features

Low $R_{DS(on)}$ ($\leq 11.7m\Omega$)
Low Thermal Resistance to PCB ($\leq 13°C/W$)
Low Profile ($\leq 1.0mm$)
Industry-Standard Pinout
Compatible with Existing Surface Mount Techniques
RoHS Compliant Containing no Lead, no Bromide and no Halogen
MSL1, Industrial Qualification

results in
⇒

Resulting Benefits

Lower Conduction Losses
Enable better thermal dissipation
Increased Power Density
Multi-Vendor Compatibility
Easier Manufacturing
Environmentally Friendlier
Increased Reliability

Orderable part number	Package Type	Standard Pack		Note
		Form	Quantity	
IRLHS6242TRPbF	PQFN 2mm x 2mm	Tape and Reel	4000	
IRLHS6242TR2PbF	PQFN 2mm x 2mm	Tape and Reel	400	EOL notice # 259

Absolute Maximum Ratings

	Parameter	Max.	Units
V_{DS}	Drain-to-Source Voltage	20	V
V_{GS}	Gate-to-Source Voltage	±12	
$I_D @ T_A = 25°C$	Continuous Drain Current, $V_{GS} @ 4.5V$	10	A
$I_D @ T_A = 70°C$	Continuous Drain Current, $V_{GS} @ 4.5V$	8.3	
$I_D @ T_{C(Bottom)} = 25°C$	Continuous Drain Current, $V_{GS} @ 4.5V$ Ⓢ	22Ⓢ	
$I_D @ T_{C(Bottom)} = 70°C$	Continuous Drain Current, $V_{GS} @ 4.5V$ Ⓢ	18Ⓢ	
$I_D @ T_{C(Bottom)} = 25°C$	Continuous Drain Current, $V_{GS} @ 4.5V$ (Package Limited)	12Ⓢ	
I_{DM}	Pulsed Drain Current ①	88	
$P_D @ T_A = 25°C$	Power Dissipation ②	1.98	W
$P_D @ T_{C(Bottom)} = 25°C$	Power Dissipation ②	9.6	
	Linear Derating Factor ③	0.016	W/°C
T_J T_{STG}	Operating Junction and Storage Temperature Range	-55 to + 150	°C

Notes ① through ③ are on page 2

Static @ T_J = 25°C (unless otherwise specified)

	Parameter	Min.	Typ.	Max.	Units	Conditions
BV _{DSS}	Drain-to-Source Breakdown Voltage	20	—	—	V	V _{GS} = 0V, I _D = 250μA
ΔBV _{DSS} /ΔT _J	Breakdown Voltage Temp. Coefficient	—	6.8	—	mV/°C	Reference to 25°C, I _D = 1mA
R _{DS(on)}	Static Drain-to-Source On-Resistance	—	9.4	11.7	mΩ	V _{GS} = 4.5V, I _D = 8.5A ③②
		—	12.4	15.5		V _{GS} = 2.5V, I _D = 8.5A ③②
V _{GS(th)}	Gate Threshold Voltage	0.5	0.8	1.1	V	V _{DS} = V _{GS} , I _D = 10μA
ΔV _{GS(th)}	Gate Threshold Voltage Coefficient	—	-4.2	—	mV/°C	
I _{DSS}	Drain-to-Source Leakage Current	—	—	1.0	μA	V _{DS} = 16V, V _{GS} = 0V
		—	—	150		V _{DS} = 16V, V _{GS} = 0V, T _J = 125°C
I _{GSS}	Gate-to-Source Forward Leakage	—	—	100	nA	V _{GS} = 12V
	Gate-to-Source Reverse Leakage	—	—	-100		V _{GS} = -12V
g _{fs}	Forward Transconductance	36	—	—	S	V _{DS} = 10V, I _D = 8.5A②
Q _g	Total Gate Charge ⑥	—	14	—	nC	V _{DS} = 10V
Q _{gs}	Gate-to-Source Charge ⑥	—	1.5	—		V _{GS} = 4.5V
Q _{gd}	Gate-to-Drain Charge ⑥	—	6.3	—		I _D = 8.5A② (See Fig.17 & 18)
R _G	Gate Resistance	—	2.1	—	Ω	
t _{d(on)}	Turn-On Delay Time	—	5.8	—	ns	V _{DD} = 10V, V _{GS} = 4.5V ③ I _D = 8.5A② R _G = 1.8Ω See Fig.15
t _r	Rise Time	—	15	—		
t _{d(off)}	Turn-Off Delay Time	—	19	—		
t _f	Fall Time	—	13	—		
C _{iss}	Input Capacitance	—	1110	—	pF	V _{GS} = 0V
C _{oss}	Output Capacitance	—	260	—		V _{DS} = 10V
C _{rss}	Reverse Transfer Capacitance	—	180	—		f = 1.0MHz

Diode Characteristics

	Parameter	Min.	Typ.	Max.	Units	Conditions
I _S	Continuous Source Current (Body Diode)	—	—	22	A	MOSFET symbol showing the integral reverse p-n junction diode.
I _{SM}	Pulsed Source Current (Body Diode) ①	—	—	88		
V _{SD}	Diode Forward Voltage	—	—	1.2	V	T _J = 25°C, I _S = 8.5A②, V _{GS} = 0V ③
t _{rr}	Reverse Recovery Time	—	15	23	ns	T _J = 25°C, I _F = 8.5A②, V _{DD} = 10V
Q _{rr}	Reverse Recovery Charge	—	12	18	nC	di/dt = 210A/μs ③
t _{on}	Forward Turn-On Time	Time is dominated by parasitic Inductance				

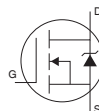

Thermal Resistance

	Parameter	Typ.	Max.	Units
R _{θJC} (Bottom)	Junction-to-Case ⑤	—	13	°C/W
R _{θJC} (Top)	Junction-to-Case ⑤	—	94	
R _{θJA}	Junction-to-Ambient ④	—	63	
R _{θJA} (<10s)	Junction-to-Ambient ④	—	46	

Notes:

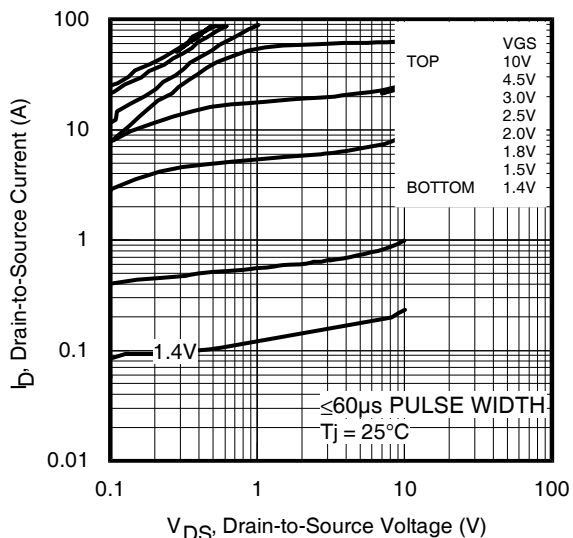
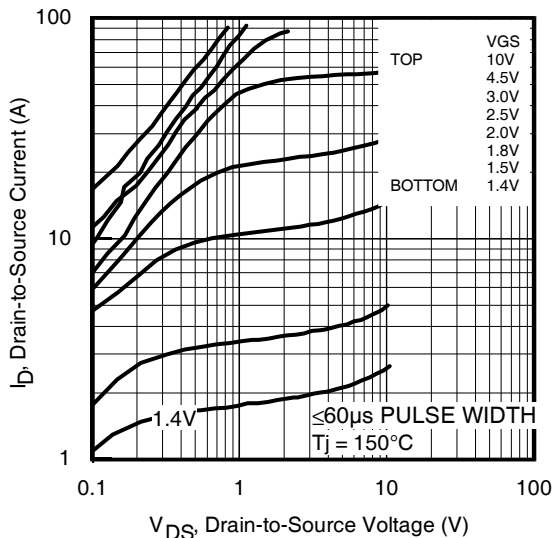
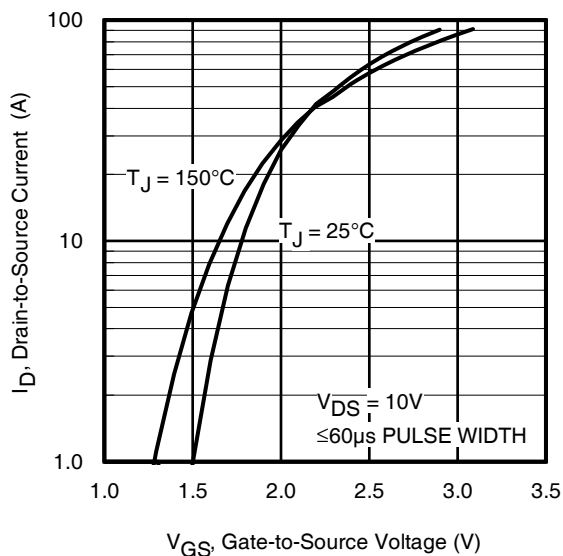
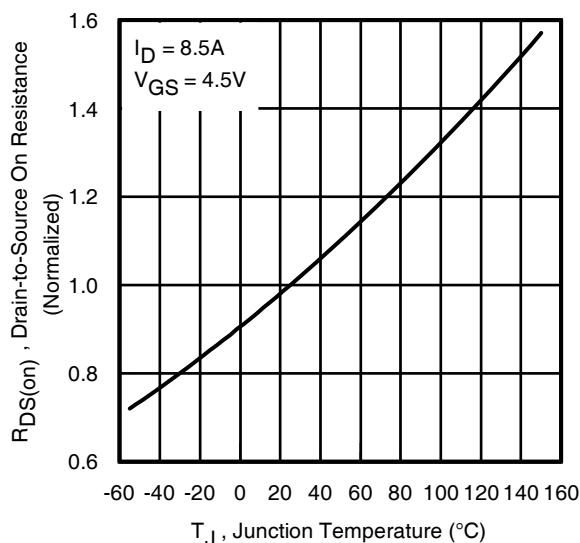
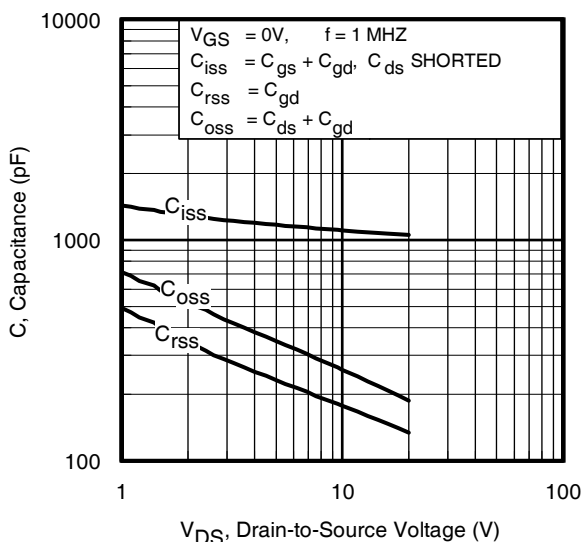
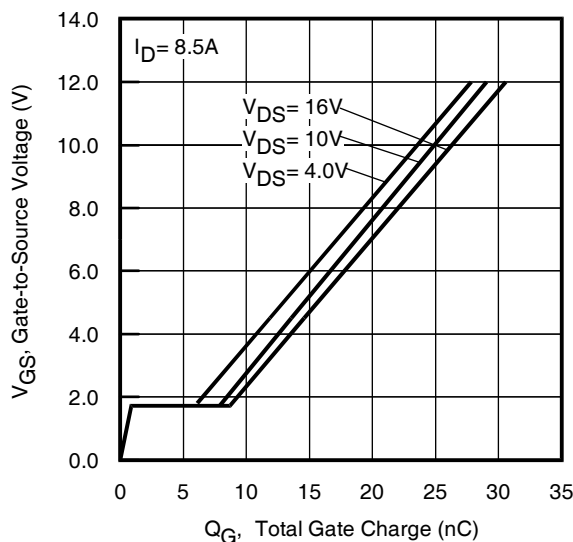
- ① Repetitive rating; pulse width limited by max. junction temperature.
- ② Package is limited to 12A by die-source to lead-frame bonding technology.
- ③ Pulse width ≤ 400μs; duty cycle ≤ 2%.
- ④ When mounted on 1 inch square copper board.
- ⑤ R_θ is measured at T_J of approximately 90°C.
- ⑥ For DESIGN AID ONLY, not subject to production testing.
- ⑦ Calculated continuous current based on maximum allowable junction temperature.

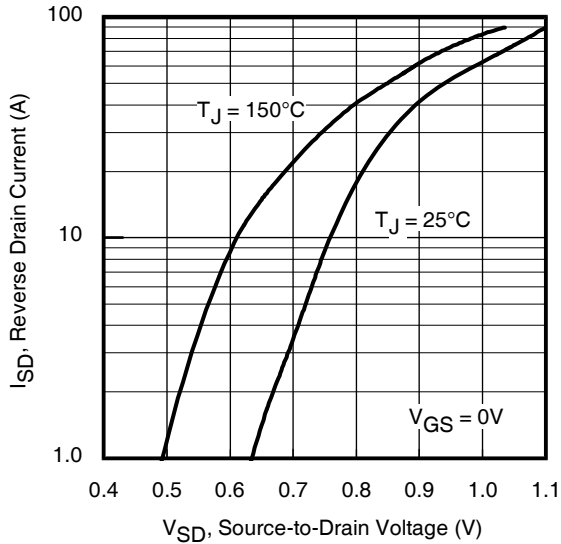
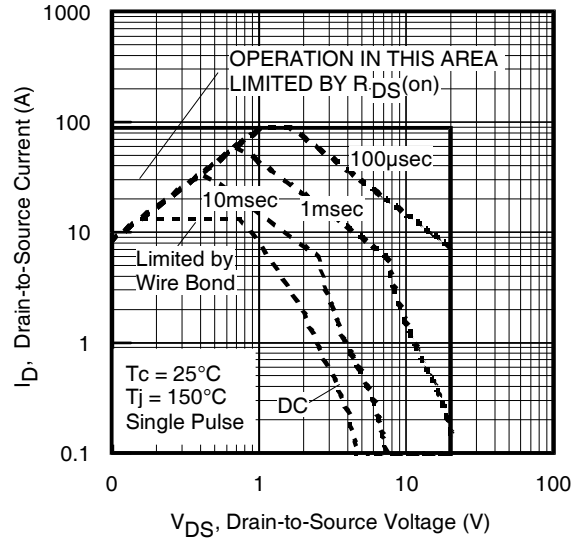
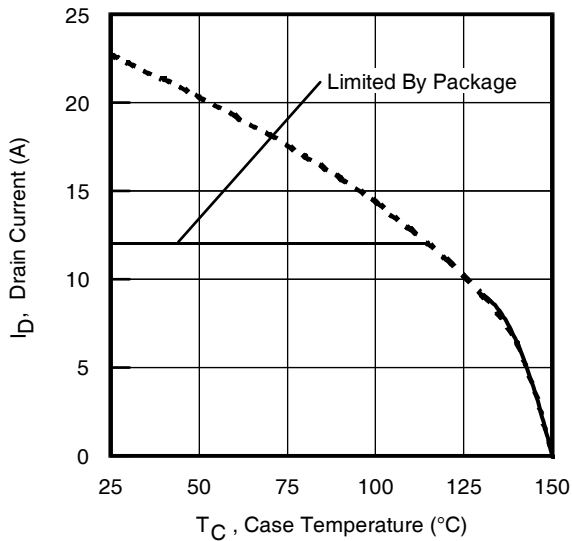
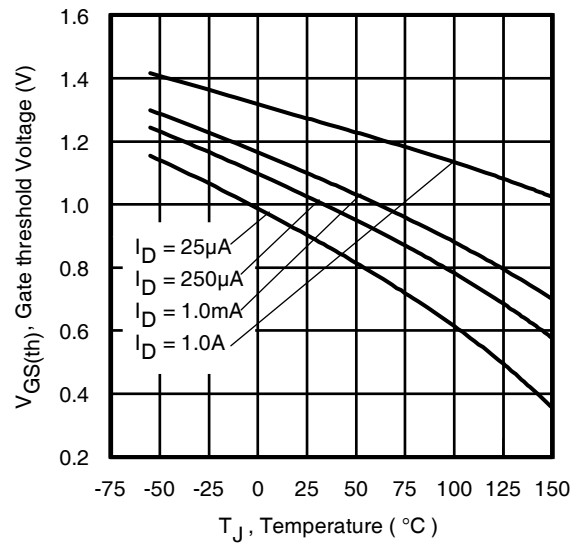
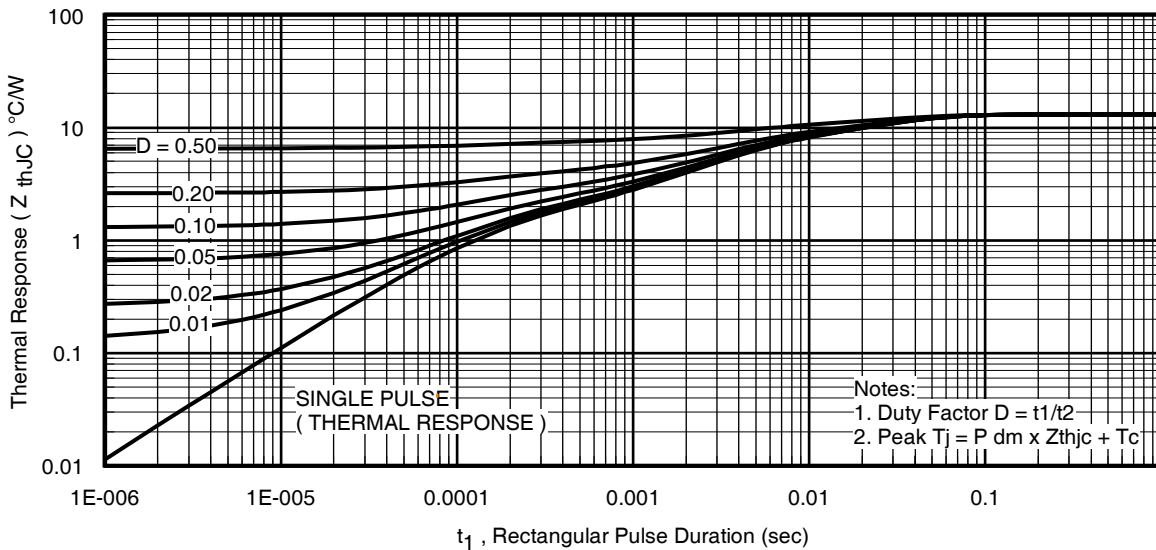
Fig 1. Typical Output Characteristics

Fig 2. Typical Output Characteristics

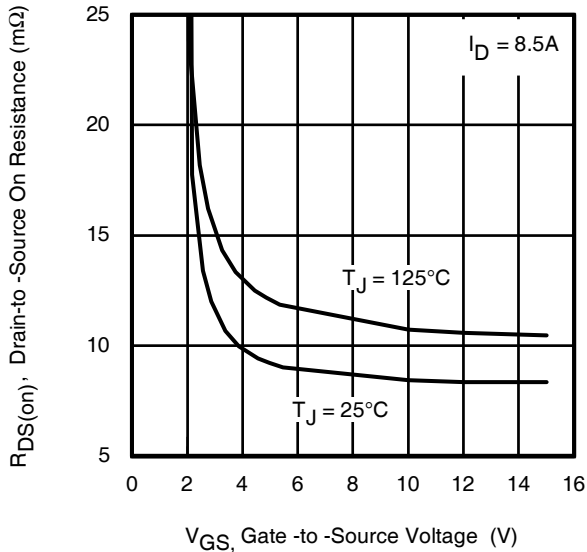
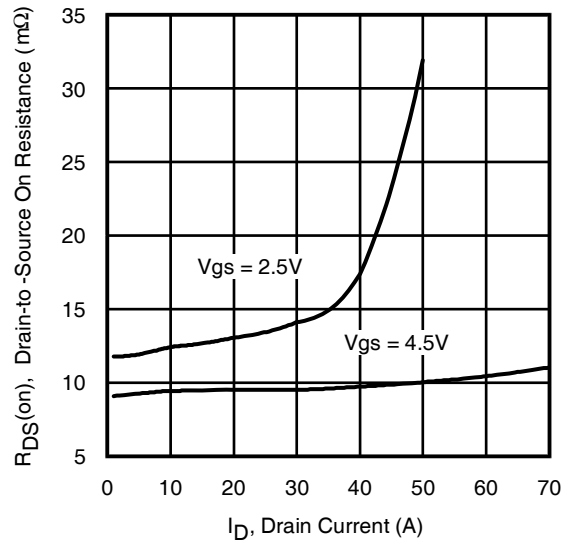
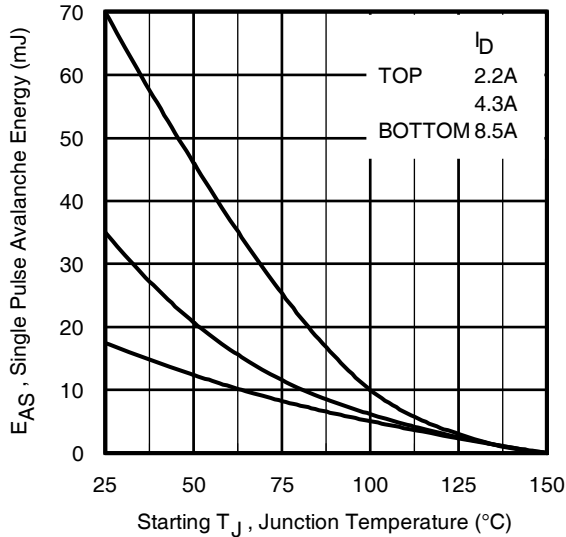
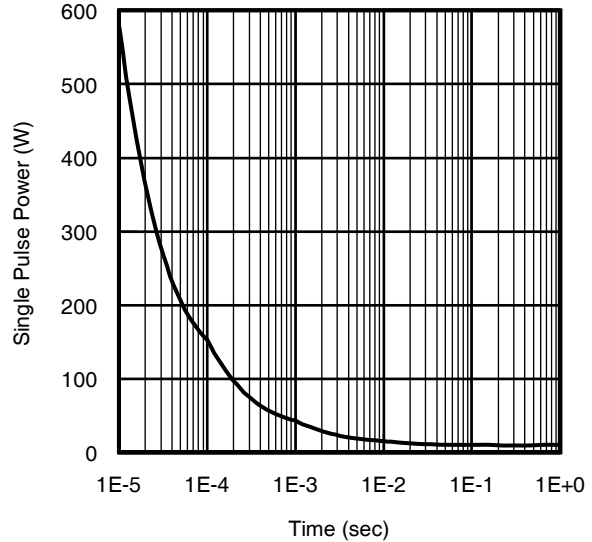
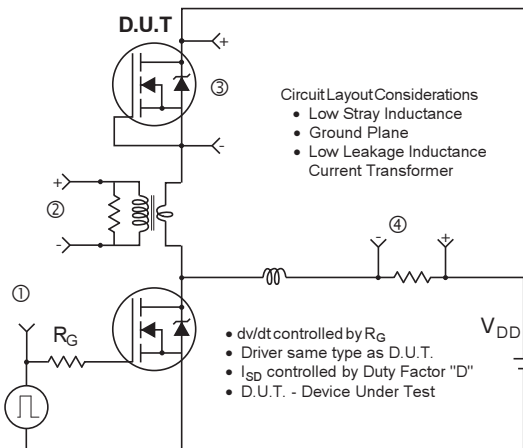
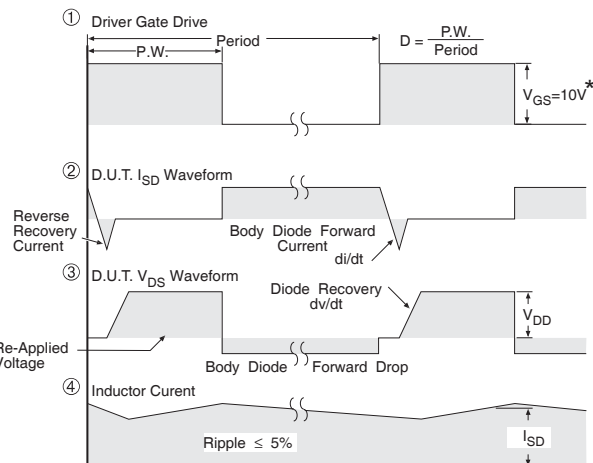
Fig 3. Typical Transfer Characteristics

Fig 4. Normalized On-Resistance vs. Temperature

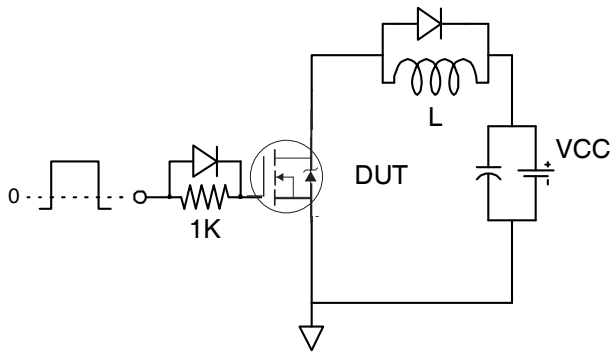
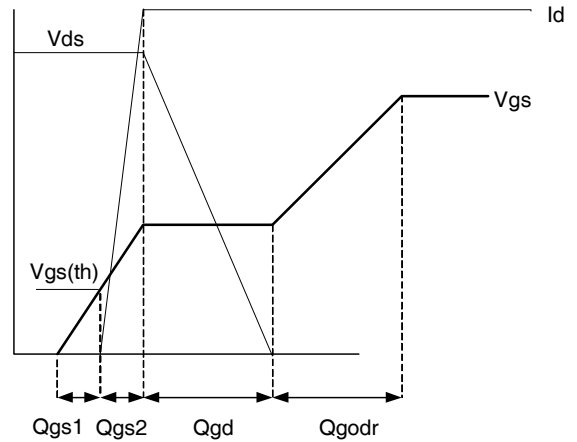
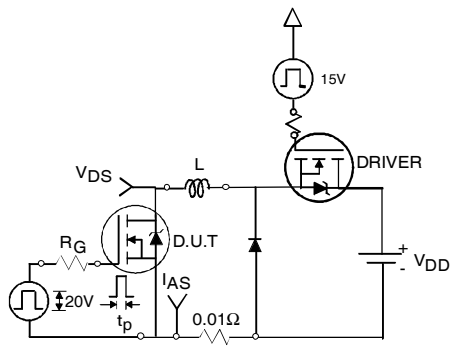
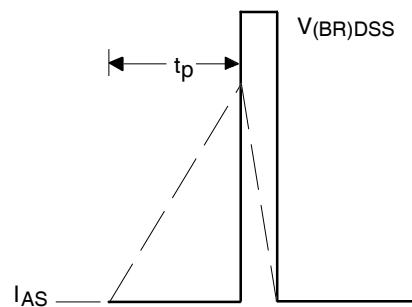
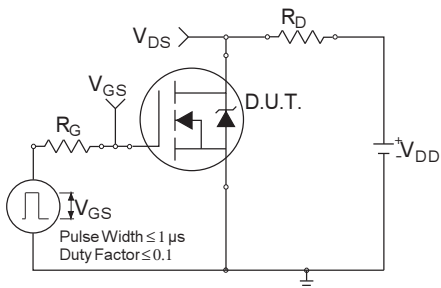
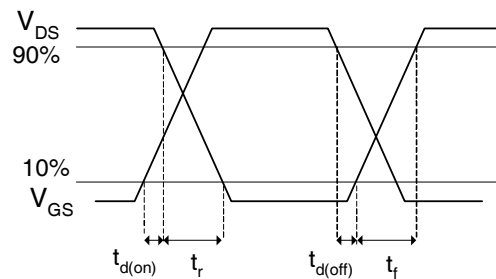
Fig 5. Typical Capacitance vs. Drain-to-Source Voltage

Fig 6. Typical Gate Charge vs. Gate-to-Source Voltage

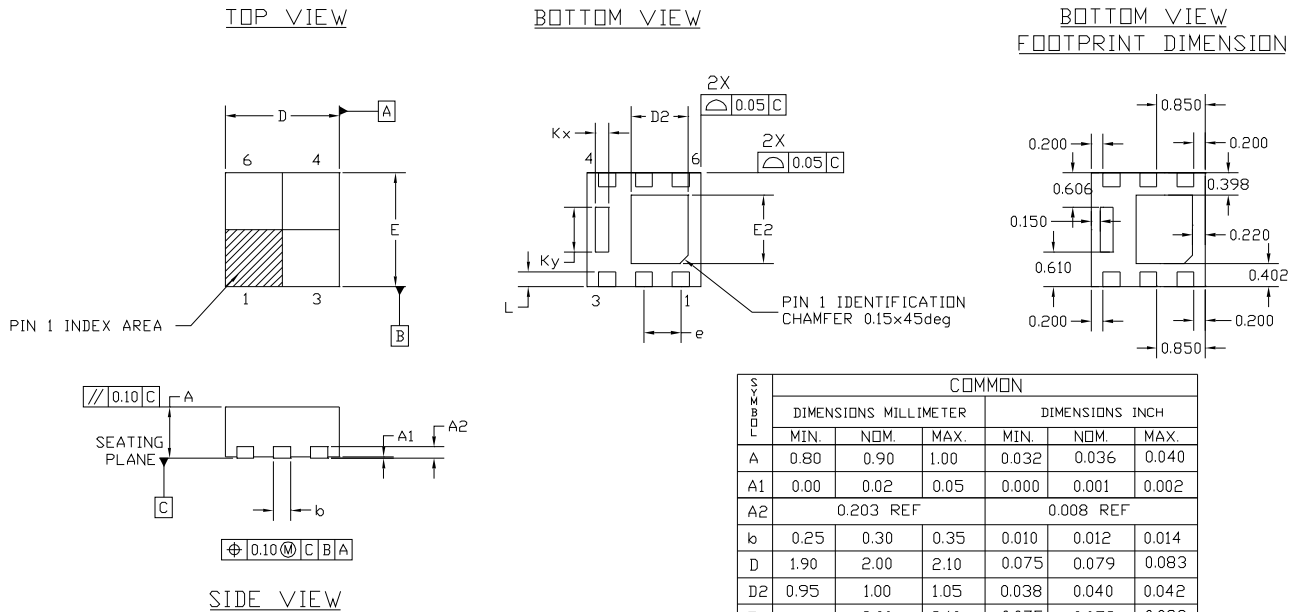

Fig 7. Typical Source-Drain Diode Forward Voltage

Fig 8. Maximum Safe Operating Area

Fig 9. Maximum Drain Current vs. Case (Bottom) Temperature

Fig 10. Threshold Voltage vs. Temperature

Fig 11. Maximum Effective Transient Thermal Impedance, Junction-to-Case (Bottom)

Fig 12. On-Resistance vs. Gate Voltage

Fig 13. Typical On-Resistance vs. Drain Current

Fig 14. Maximum Avalanche Energy vs. Drain Current

Fig 15. Typical Power vs. Time

Fig 16. Peak Diode Recovery dv/dt Test Circuit for N-Channel HEXFET[®] Power MOSFETs

* $V_{GS} = 5V$ for Logic Level Devices

Fig 17a. Gate Charge Test Circuit

Fig 17b. Gate Charge Waveform

Fig 18a. Unclamped Inductive Test Circuit

Fig 18b. Unclamped Inductive Waveforms

Fig 19a. Switching Time Test Circuit

Fig 19b. Switching Time Waveforms

PQFN 2x2 Outline Package Details



NOTES :

1. DIMENSION AND TOLERANCING CONFORM TO ASME Y14.5M-1994.
2. CONTROLLING DIMENSIONS : MILLIMETER
3. DIMENSION b APPLIES TO METALLIZED TERMINAL AND IS MEASURED BETWEEN 0.15 AND 0.30 mm. FROM TERMINAL TIP.

For footprint and stencil design recommendations, please refer to application note AN-1154 at <http://www.irf.com/technical-info/appnotes/an-1154.pdf>

PQFN 2x2 Outline Part Marking

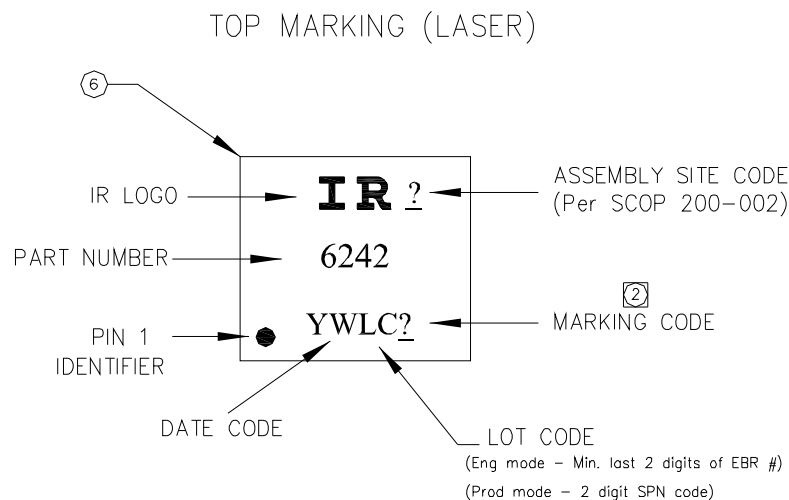

Note: For the most current drawing please refer to IR website at: <http://www.irf.com/package/>

PQFN 2x2 Outline Tape and Reel

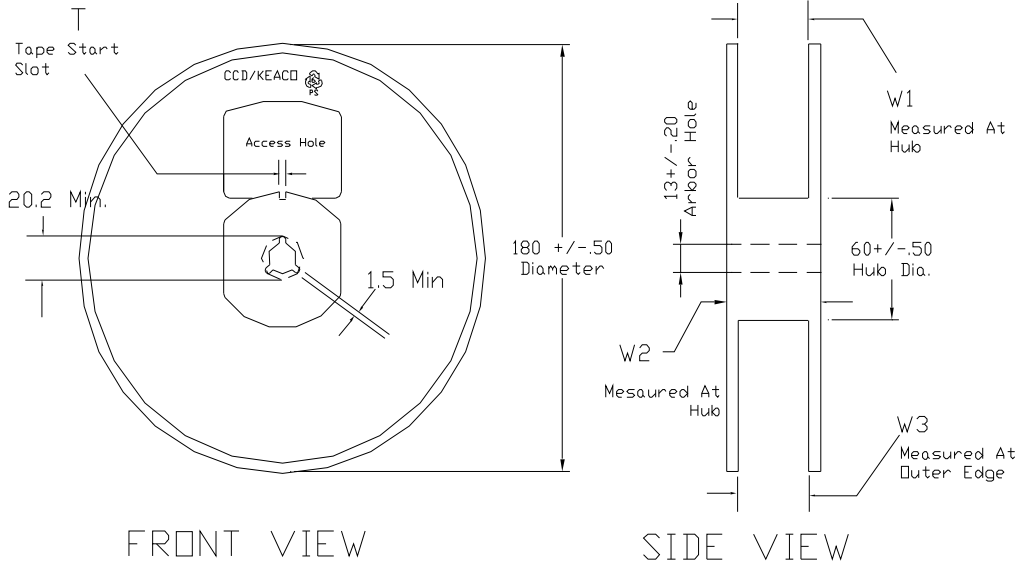
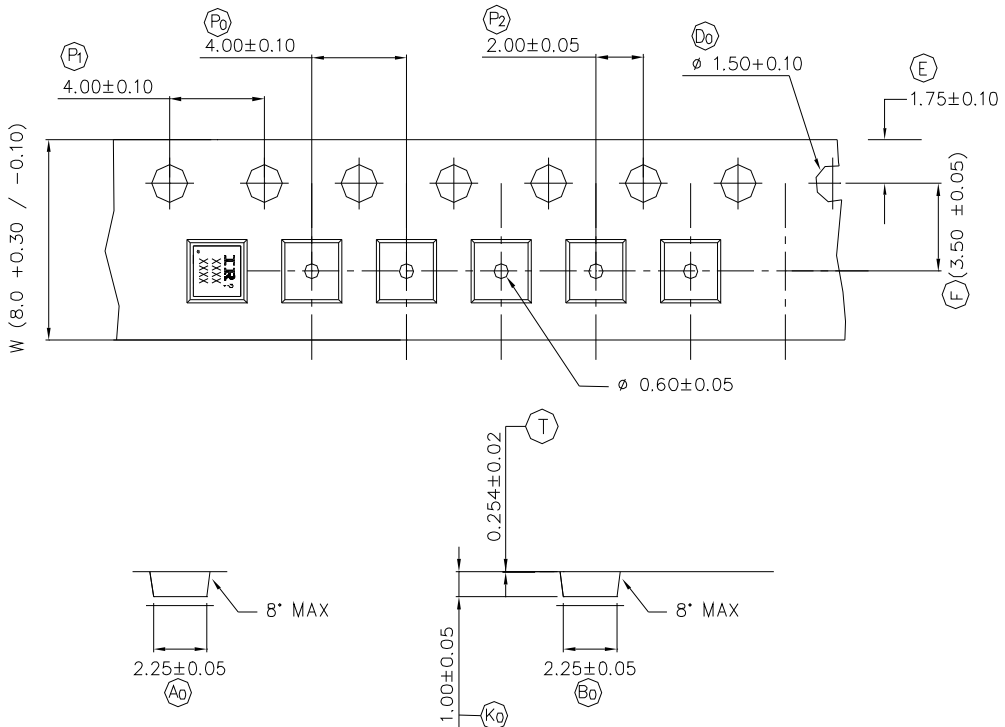

TABLE 1: REEL DETAILS

TAPE WIDTH	T	W1	W2	W3	PART NO
8 MM	3 ± 0.50	8.4 ^{+1.5} _{-0.0}	14.4 Max	7.90 Min 10.9 Max	91586-1
12 MM	5 ± 0.50	12.4 ^{+2.0} _{-0.0}	18.4 Max	11.9 Min 15.4 Max	91586-2

Note: Surface resistivity is $\geq 1 \times 10^5$ but $< 1 \times 10^{12}$ ohm/sq.



NOTE: The Surface Resistivity is $10^4 - 10^8$ OHM/SQ

Qualification information[†]

Qualification level	Industrial [†] (per JEDEC JESD47F ^{††} guidelines)	
Moisture Sensitivity Level	PQFN 2mm x 2mm	MSL1 (per JEDEC J-STD-020D ^{††})
RoHS compliant	Yes	

† Qualification standards can be found at International Rectifier's web site

<http://www.irf.com/product-info/reliability>

†† Applicable version of JEDEC standard at the time of product release.

Revision History

Date	Comments
12/17/2013	<ul style="list-style-type: none"> • Updated ordering information to reflect the End-Of-life (EOL) of the mini-reel option (EOL notice #259) • Updated Qual level from "Consumer" to "Industrial" on page 1, 9 • Updated data sheet with new IR corporate template

International
 Rectifier

IR WORLD HEADQUARTERS: 101 N. Sepulveda Blvd., El Segundo, California 90245, USA

To contact International Rectifier, please visit <http://www.irf.com/whoto-call/>

IMPORTANT NOTICE

The information given in this document shall in no event be regarded as a guarantee of conditions or characteristics ("Beschaffheitsgarantie").

With respect to any examples, hints or any typical values stated herein and/or any information regarding the application of the product, Infineon Technologies hereby disclaims any and all warranties and liabilities of any kind, including without limitation warranties of non-infringement of intellectual property rights of any third party.

In addition, any information given in this document is subject to customer's compliance with its obligations stated in this document and any applicable legal requirements, norms and standards concerning customer's products and any use of the product of Infineon Technologies in customer's applications.

The data contained in this document is exclusively intended for technically trained staff. It is the responsibility of customer's technical departments to evaluate the suitability of the product for the intended application and the completeness of the product information given in this document with respect to such application.

For further information on the product, technology, delivery terms and conditions and prices please contact your nearest Infineon Technologies office (www.infineon.com).

WARNINGS

Due to technical requirements products may contain dangerous substances. For information on the types in question please contact your nearest Infineon Technologies office.

Except as otherwise explicitly approved by Infineon Technologies in a written document signed by authorized representatives of Infineon Technologies, Infineon Technologies' products may not be used in any applications where a failure of the product or any consequences of the use thereof can reasonably be expected to result in personal injury.