

IGBT

High speed 5 FAST IGBT in TRENCHSTOP™ 5 technology

IGW40N65H5A

650V IGBT
High speed switching series fifth generation

Data sheet

Industrial Power Control

High speed 5 FAST IGBT in TRENCHSTOP™ 5 technology

Features and Benefits:

High speed H5 technology offering

- Best-in-Class efficiency in hard switching and resonant topologies
- Plug and play replacement of previous generation IGBTs
- 650V breakdown voltage
- Low gate charge Q_G
- Maximum junction temperature 175°C
- Qualified according to AEC-Q101
- Green package (RoHS compliant)
- Complete product spectrum and PSpice Models:
<http://www.infineon.com/igbt/>

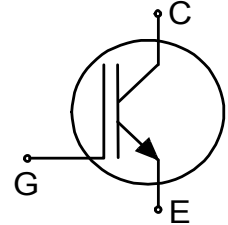

Applications:

- Battery charger
- DC/DC converter

Package pin definition:

- Pin 1 - gate
- Pin 2 & backside - collector
- Pin 3 - emitter



Key Performance and Package Parameters

Type	V_{CE}	I_C	$V_{CEsat}, T_{vj}=25^\circ C$	T_{vjmax}	Marking	Package
IGW40N65H5A	650V	40A	1.66V	175°C	G40EH5A	PG-TO247-3



Table of Contents

Description 2

Table of Contents 3

Maximum Ratings 4

Thermal Resistance 4

Electrical Characteristics 4

Electrical Characteristics Diagrams 7

Package Drawing12

Testing Conditions13

Revision History14

Disclaimer14

Maximum Ratings

For optimum lifetime and reliability, Infineon recommends operating conditions that do not exceed 80% of the maximum ratings stated in this datasheet.

Parameter	Symbol	Value	Unit
Collector-emitter voltage, $T_{vj} \geq 25^{\circ}\text{C}$	V_{CE}	650	V
DC collector current, limited by T_{vjmax} $T_C = 25^{\circ}\text{C}$ $T_C = 100^{\circ}\text{C}$	I_C	74.0 46.0	A
Pulsed collector current, t_p limited by $T_{vjmax}^{1)}$	I_{Cpuls}	120.0	A
Turn off safe operating area $V_{CE} \leq 650\text{V}$, $T_{vj} \leq 175^{\circ}\text{C}$, $t_p = 1\mu\text{s}^{1)}$	-	120.0	A
Gate-emitter voltage Transient Gate-emitter voltage ($t_p \leq 10\mu\text{s}$, $D < 0.010$)	V_{GE}	± 20 ± 30	V
Power dissipation $T_C = 25^{\circ}\text{C}$ Power dissipation $T_C = 100^{\circ}\text{C}$	P_{tot}	250.0 125.0	W
Operating junction temperature	T_{vj}	-40...+175	$^{\circ}\text{C}$
Storage temperature	T_{stg}	-55...+150	$^{\circ}\text{C}$
Soldering temperature, ²⁾ wave soldering 1.6mm (0.063in.) from case for 10s		260	$^{\circ}\text{C}$
Mounting torque, M3 screw Maximum of mounting processes: 3	M	0.6	Nm

Thermal Resistance

Parameter	Symbol	Conditions	Max. Value	Unit
Characteristic				
IGBT thermal resistance, junction - case	$R_{th(j-c)}$		0.60	K/W
Thermal resistance junction - ambient	$R_{th(j-a)}$		40	K/W

Electrical Characteristic, at $T_{vj} = 25^{\circ}\text{C}$, unless otherwise specified

Parameter	Symbol	Conditions	Value			Unit
			min.	typ.	max.	
Static Characteristic						
Collector-emitter breakdown voltage	$V_{(BR)CES}$	$V_{GE} = 0\text{V}$, $I_C = 0.20\text{mA}$	650	-	-	V
Collector-emitter saturation voltage	V_{CEsat}	$V_{GE} = 15.0\text{V}$, $I_C = 40.0\text{A}$ $T_{vj} = 25^{\circ}\text{C}$ $T_{vj} = 125^{\circ}\text{C}$ $T_{vj} = 175^{\circ}\text{C}$	- - -	1.66 1.85 2.05	2.10 - -	V
Gate-emitter threshold voltage	$V_{GE(th)}$	$I_C = 0.40\text{mA}$, $V_{CE} = V_{GE}$	3.2	4.0	4.8	V
Zero gate voltage collector current	I_{CES}	$V_{CE} = 650\text{V}$, $V_{GE} = 0\text{V}$ $T_{vj} = 25^{\circ}\text{C}$ $T_{vj} = 175^{\circ}\text{C}$	- -	- 500.0	40.0 -	μA
Gate-emitter leakage current	I_{GES}	$V_{CE} = 0\text{V}$, $V_{GE} = 20\text{V}$	-	-	100	nA
Transconductance	g_{fs}	$V_{CE} = 20\text{V}$, $I_C = 40.0\text{A}$	-	50.0	-	S

¹⁾ Defined by design. Not subject to production test.

²⁾ Package not recommended for surface mount applications

Electrical Characteristic, at $T_{vj} = 25^{\circ}\text{C}$, unless otherwise specified

Parameter	Symbol	Conditions	Value			Unit
			min.	typ.	max.	
Dynamic Characteristic						
Input capacitance	C_{ies}	$V_{CE} = 25\text{V}, V_{GE} = 0\text{V}, f = 1\text{MHz}$	-	2300	-	pF
Output capacitance	C_{oes}		-	43	-	
Reverse transfer capacitance	C_{res}		-	9	-	
Gate charge	Q_G	$V_{CC} = 520\text{V}, I_C = 40.0\text{A}, V_{GE} = 15\text{V}$	-	92.0	-	nC
Internal emitter inductance measured 5mm (0.197 in.) from case	L_E		-	13.0	-	nH

Switching Characteristic, Inductive Load

Parameter	Symbol	Conditions	Value			Unit
			min.	typ.	max.	

IGBT Characteristic, at $T_{vj} = 25^{\circ}\text{C}$

Turn-on delay time	$t_{d(on)}$	$T_{vj} = 25^{\circ}\text{C}, V_{CC} = 400\text{V}, I_C = 20.0\text{A}, V_{GE} = 0.0/15.0\text{V}, R_{G(on)} = 15.0\Omega, R_{G(off)} = 15.0\Omega, L\sigma = 30\text{nH}, C\sigma = 30\text{pF}$ Energy losses include "tail" and diode reverse recovery.	-	20	-	ns
Rise time	t_r		-	11	-	ns
Turn-off delay time	$t_{d(off)}$		-	149	-	ns
Fall time	t_f		-	11	-	ns
Turn-on energy	E_{on}		-	0.36	-	mJ
Turn-off energy	E_{off}		-	0.11	-	mJ
Total switching energy	E_{ts}		-	0.47	-	mJ
Turn-on delay time	$t_{d(on)}$	$T_{vj} = 25^{\circ}\text{C}, V_{CC} = 400\text{V}, I_C = 5.0\text{A}, V_{GE} = 0.0/15.0\text{V}, R_{G(on)} = 15.0\Omega, R_{G(off)} = 15.0\Omega, L\sigma = 30\text{nH}, C\sigma = 30\text{pF}$ Energy losses include "tail" and diode reverse recovery.	-	18	-	ns
Rise time	t_r		-	4	-	ns
Turn-off delay time	$t_{d(off)}$		-	156	-	ns
Fall time	t_f		-	24	-	ns
Turn-on energy	E_{on}		-	0.08	-	mJ
Turn-off energy	E_{off}		-	0.03	-	mJ
Total switching energy	E_{ts}		-	0.11	-	mJ

Switching Characteristic, Inductive Load

Parameter	Symbol	Conditions	Value			Unit
			min.	typ.	max.	
IGBT Characteristic, at $T_{vj} = 150^{\circ}\text{C}$						
Turn-on delay time	$t_{d(on)}$	$T_{vj} = 150^{\circ}\text{C},$	-	19	-	ns
Rise time	t_r	$V_{CC} = 400\text{V}, I_C = 20.0\text{A},$	-	12	-	ns
Turn-off delay time	$t_{d(off)}$	$V_{GE} = 0.0/15.0\text{V},$	-	186	-	ns
Fall time	t_f	$R_{G(on)} = 15.0\Omega, R_{G(off)} = 15.0\Omega,$	-	17	-	ns
Turn-on energy	E_{on}	$L\sigma = 30\text{nH}, C\sigma = 30\text{pF}$	-	0.55	-	mJ
Turn-off energy	E_{off}	$L\sigma, C\sigma$ from Fig. E	-	0.22	-	mJ
Total switching energy	E_{ts}	Energy losses include "tail" and diode reverse recovery.	-	0.77	-	mJ
Turn-on delay time	$t_{d(on)}$	$T_{vj} = 150^{\circ}\text{C},$	-	17	-	ns
Rise time	t_r	$V_{CC} = 400\text{V}, I_C = 5.0\text{A},$	-	5	-	ns
Turn-off delay time	$t_{d(off)}$	$V_{GE} = 0.0/15.0\text{V},$	-	212	-	ns
Fall time	t_f	$R_{G(on)} = 15.0\Omega, R_{G(off)} = 15.0\Omega,$	-	36	-	ns
Turn-on energy	E_{on}	$L\sigma = 30\text{nH}, C\sigma = 30\text{pF}$	-	0.16	-	mJ
Turn-off energy	E_{off}	$L\sigma, C\sigma$ from Fig. E	-	0.07	-	mJ
Total switching energy	E_{ts}	Energy losses include "tail" and diode reverse recovery.	-	0.23	-	mJ

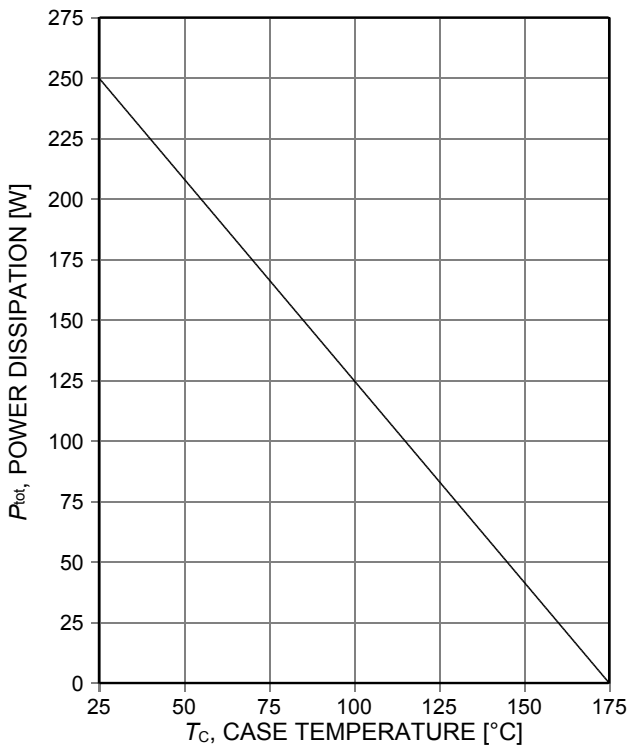

Figure 1. Power dissipation as a function of case temperature ($T_{vj} \leq 175^\circ\text{C}$)

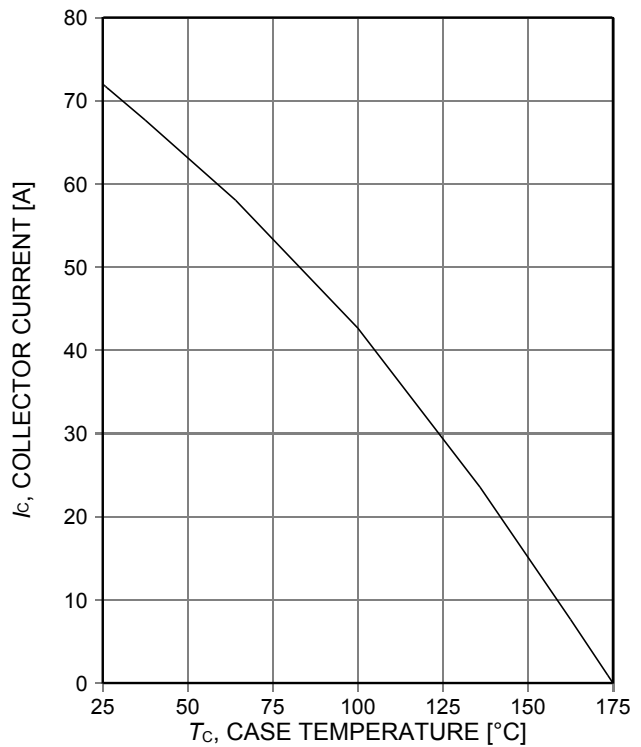

Figure 2. Collector current as a function of case temperature ($V_{GE} \geq 15\text{V}$, $T_{vj} \leq 175^\circ\text{C}$)

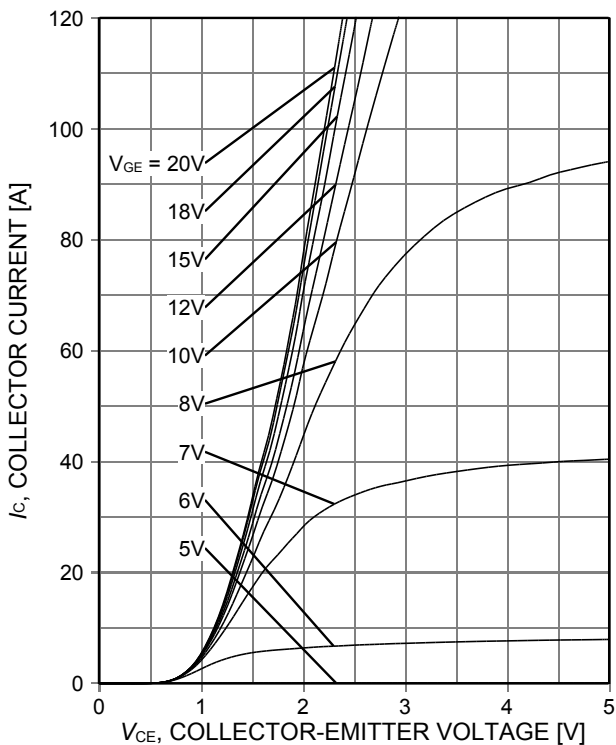

Figure 3. Typical output characteristic ($T_{vj} = 25^\circ\text{C}$)

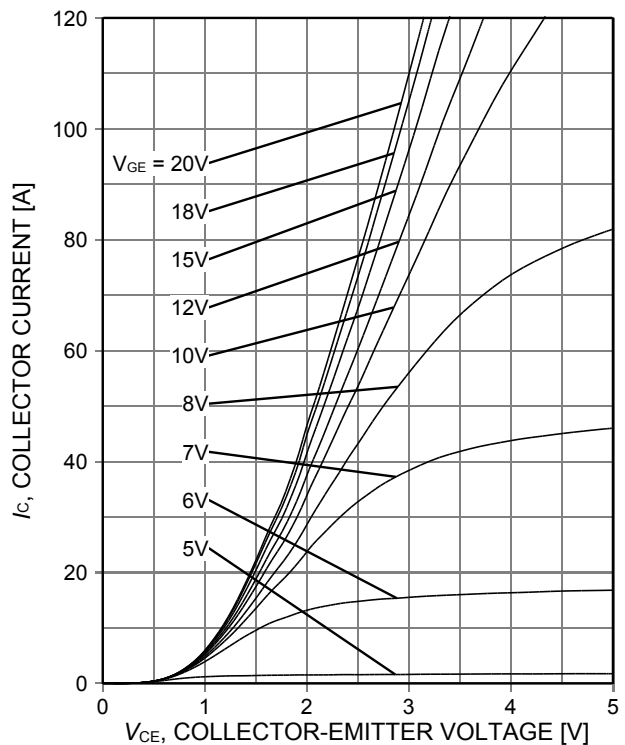

Figure 4. Typical output characteristic ($T_{vj} = 150^\circ\text{C}$)

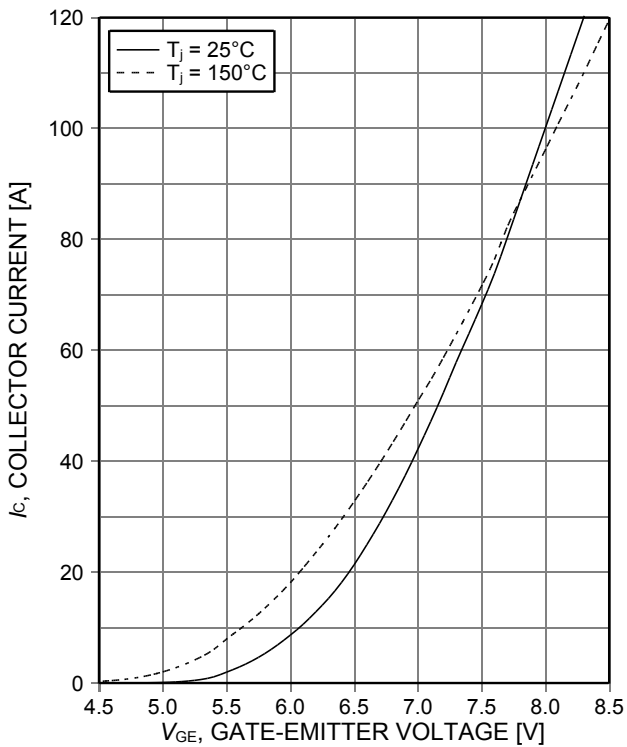

Figure 5. **Typical transfer characteristic**
($V_{CE}=20V$)

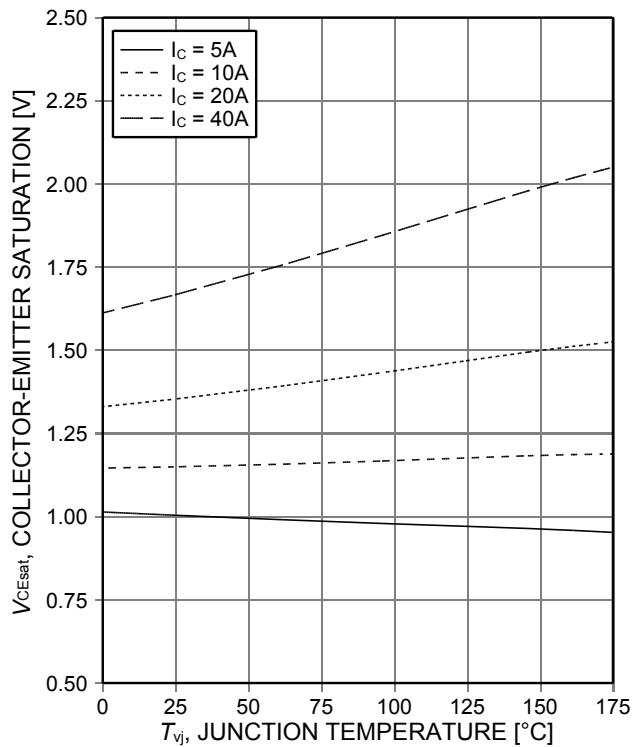

Figure 6. **Typical collector-emitter saturation voltage as a function of junction temperature**
($V_{GE}=15V$)

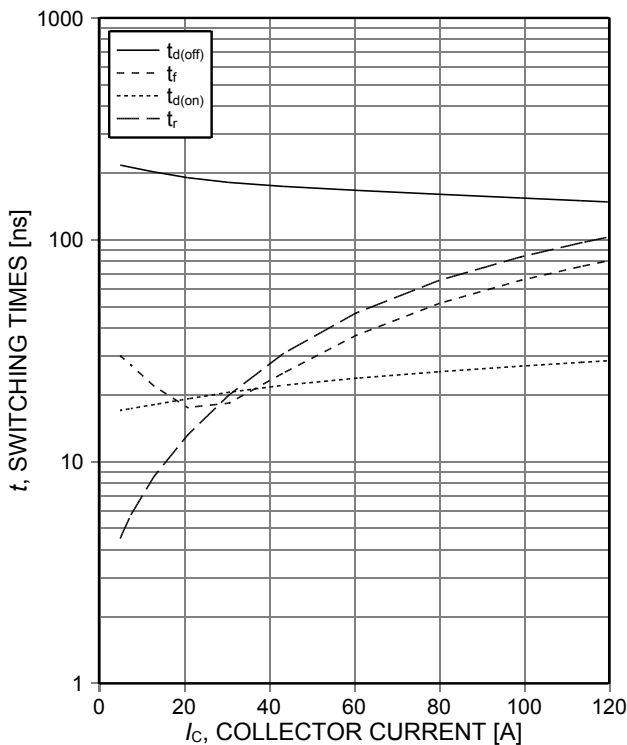

Figure 7. **Typical switching times as a function of collector current**
(inductive load, $T_{vj}=150^{\circ}C$, $V_{CE}=400V$, $V_{GE}=15/0V$, $r_G=15\Omega$, Dynamic test circuit in Figure E)

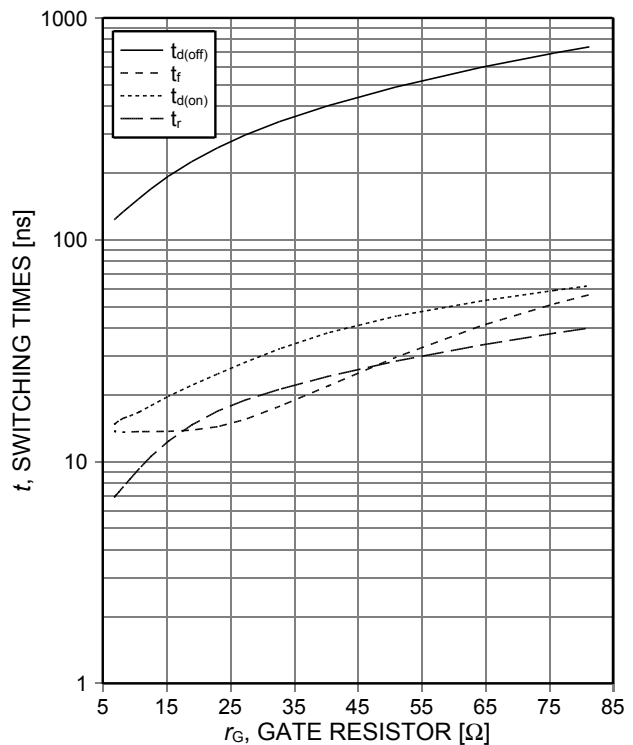

Figure 8. **Typical switching times as a function of gate resistor**
(inductive load, $T_{vj}=150^{\circ}C$, $V_{CE}=400V$, $V_{GE}=15/0V$, $I_C=20A$, Dynamic test circuit in Figure E)

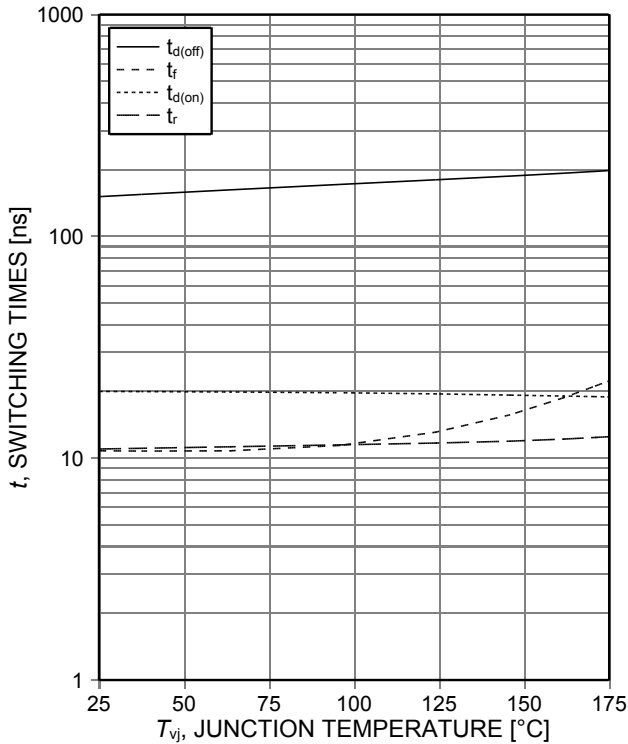

Figure 9. **Typical switching times as a function of junction temperature**
 (inductive load, $V_{CE}=400V$, $V_{GE}=15/0V$, $I_C=20A$, $r_G=15\Omega$, Dynamic test circuit in Figure E)

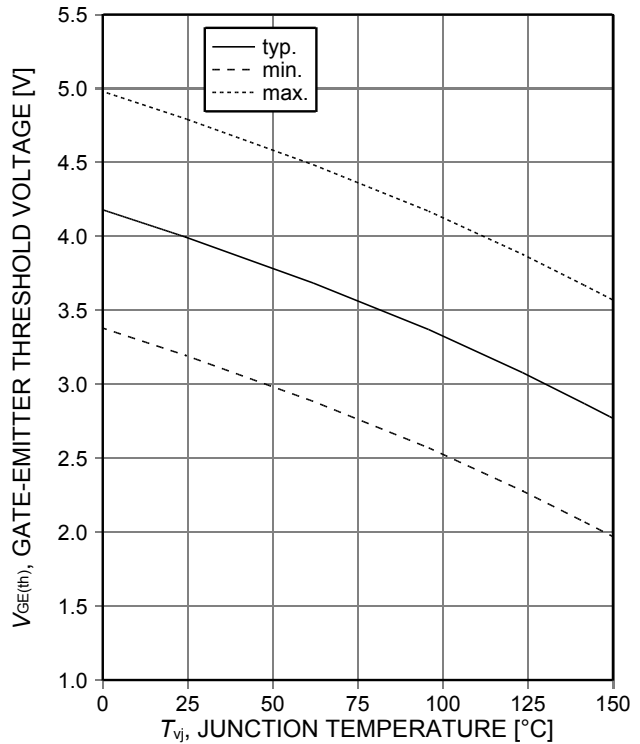

Figure 10. **Gate-emitter threshold voltage as a function of junction temperature**
 ($I_C=0.4mA$)

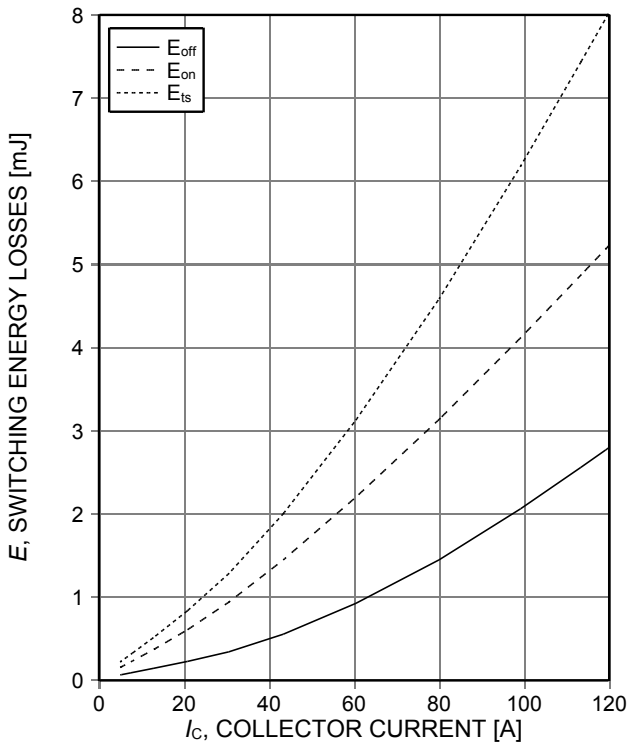

Figure 11. **Typical switching energy losses as a function of collector current**
 (inductive load, $T_{vj}=150^\circ C$, $V_{CE}=400V$, $V_{GE}=15/0V$, $r_G=15\Omega$, Dynamic test circuit in Figure E)

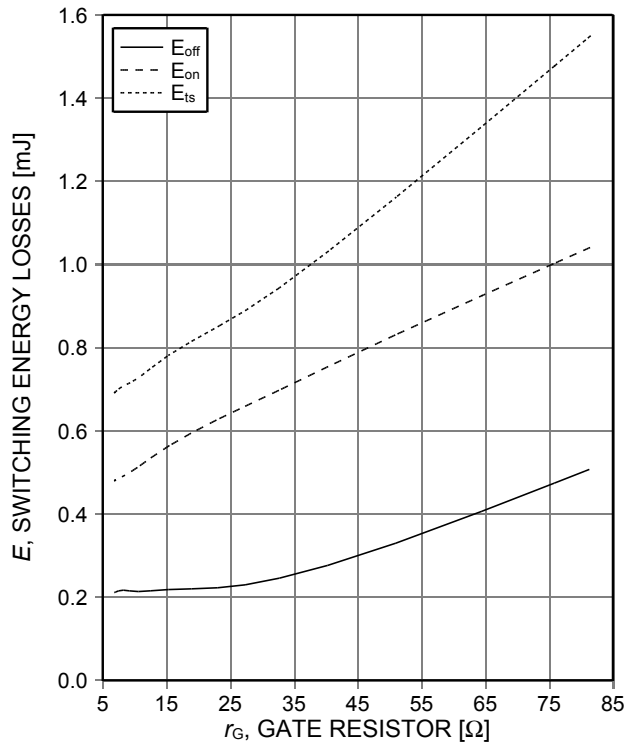

Figure 12. **Typical switching energy losses as a function of gate resistor**
 (inductive load, $T_{vj}=150^\circ C$, $V_{CE}=400V$, $V_{GE}=15/0V$, $I_C=20A$, Dynamic test circuit in Figure E)

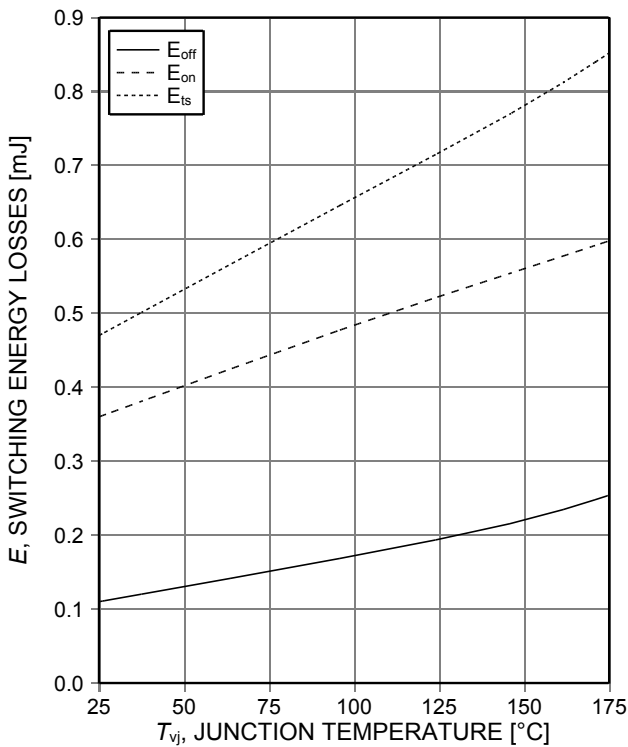

Figure 13. **Typical switching energy losses as a function of junction temperature**
(inductive load, $V_{CE}=400V$, $V_{GE}=15/0V$, $I_C=20A$, $r_G=15\Omega$, Dynamic test circuit in Figure E)

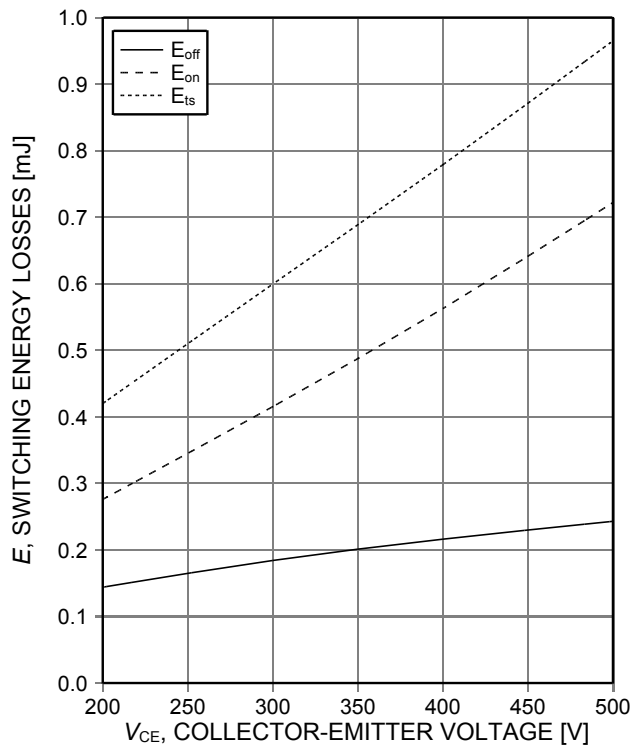

Figure 14. **Typical switching energy losses as a function of collector-emitter voltage**
(inductive load, $T_{vj}=150^\circ C$, $V_{GE}=15/0V$, $I_C=20A$, $r_G=15\Omega$, Dynamic test circuit in Figure E)

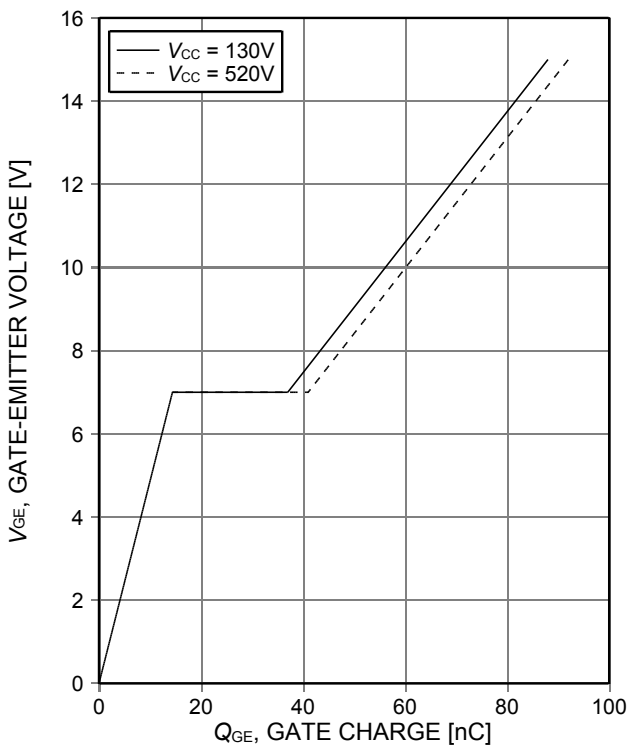

Figure 15. **Typical gate charge**
($I_C=40A$)

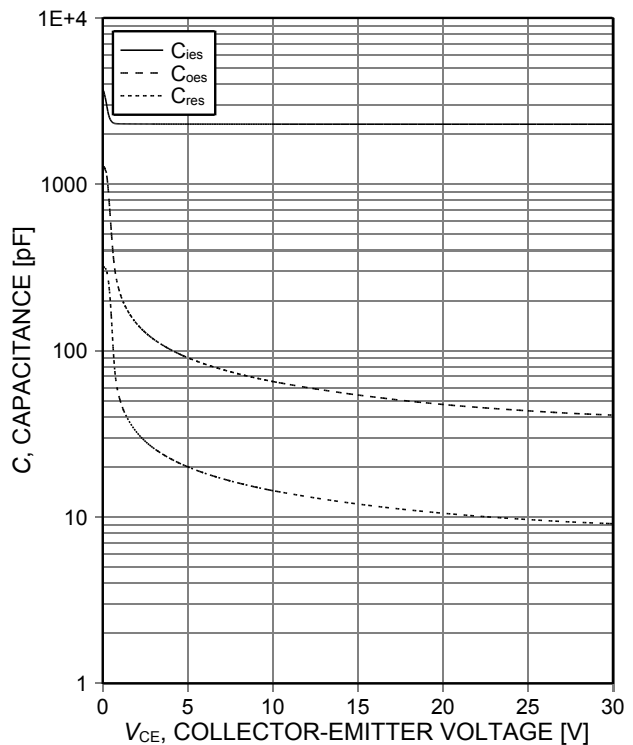

Figure 16. **Typical capacitance as a function of collector-emitter voltage**
($V_{GE}=0V$, $f=1MHz$)

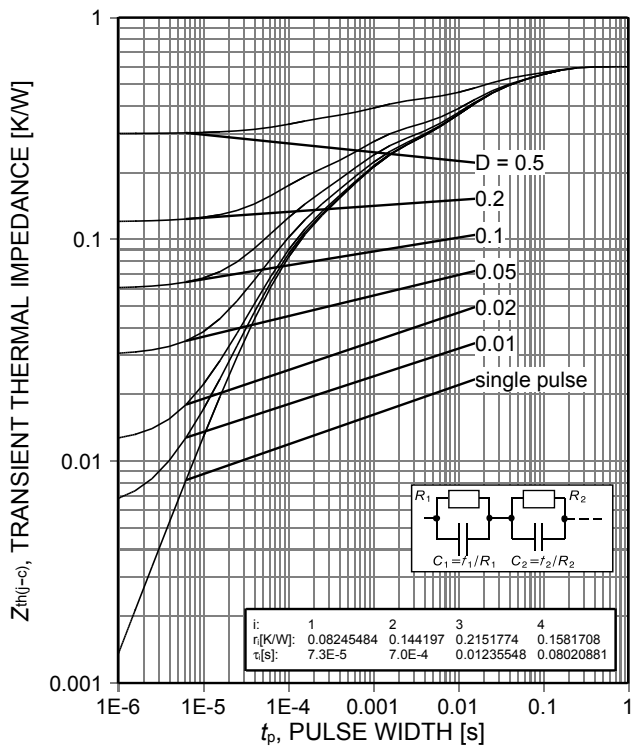
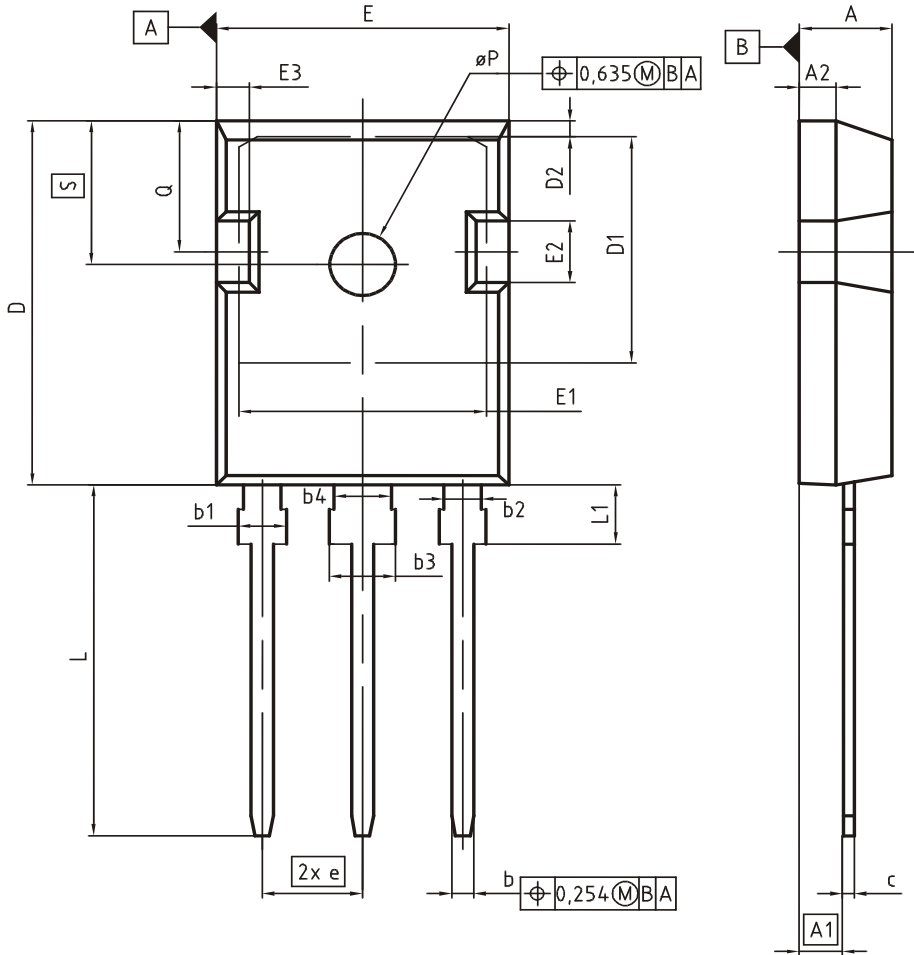

Figure 17. IGBT transient thermal impedance ($D = t_p / T$)

PG-TO247-3



DIM	MILLIMETERS		INCHES	
	MIN	MAX	MIN	MAX
A	4.83	5.21	0.190	0.205
A1	2.27	2.54	0.089	0.100
A2	1.85	2.16	0.073	0.085
b	1.07	1.33	0.042	0.052
b1	1.90	2.41	0.075	0.095
b2	1.90	2.16	0.075	0.085
b3	2.87	3.38	0.113	0.133
b4	2.87	3.13	0.113	0.123
c	0.55	0.68	0.022	0.027
D	20.80	21.10	0.819	0.831
D1	16.25	17.65	0.640	0.695
D2	0.95	1.35	0.037	0.053
E	15.70	16.13	0.618	0.635
E1	13.10	14.15	0.516	0.557
E2	3.68	5.10	0.145	0.201
E3	1.00	2.60	0.039	0.102
e	5.44 (BSC)		0.214 (BSC)	
N	3		3	
L	19.80	20.32	0.780	0.800
L1	4.10	4.47	0.161	0.176
ϕP	3.50	3.70	0.138	0.146
Q	5.49	6.00	0.216	0.236
S	6.04	6.30	0.238	0.248

DOCUMENT NO.
Z8B00003327

SCALE

EUROPEAN PROJECTION

ISSUE DATE
09-07-2010

REVISION
05

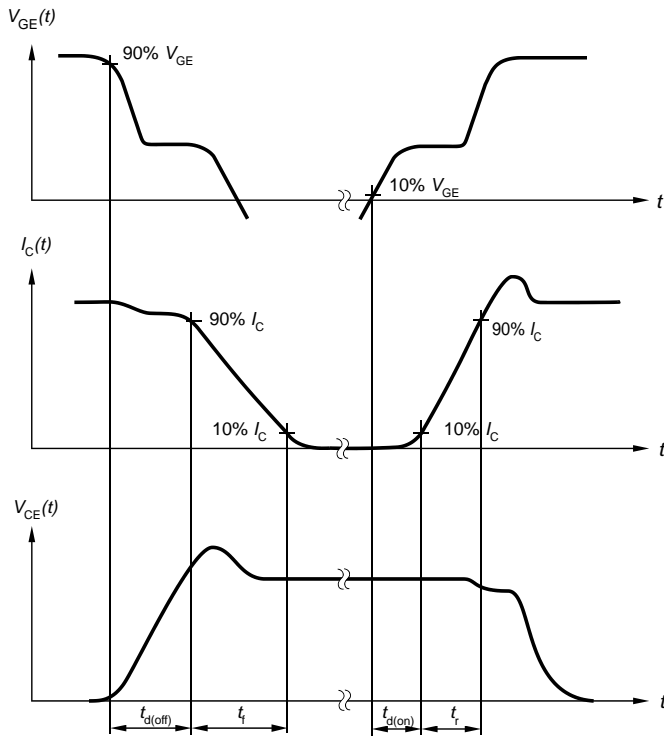

Figure A. Definition of switching times

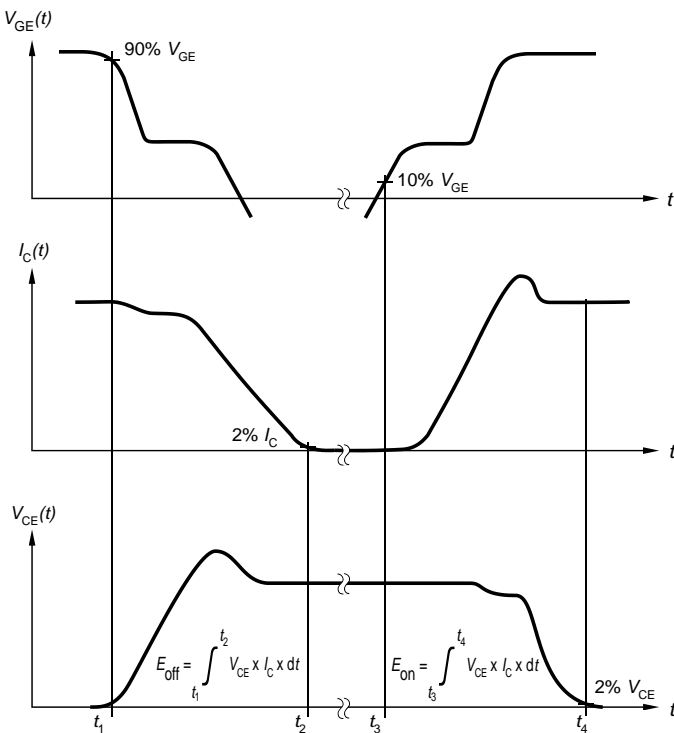

Figure B. Definition of switching losses

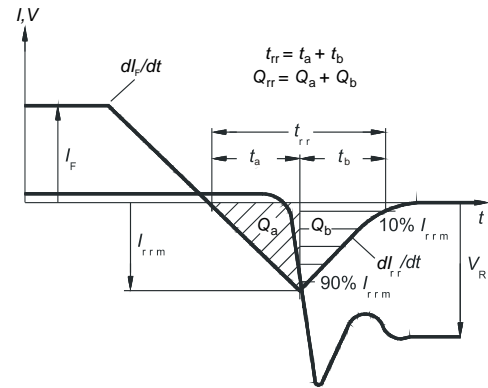

Figure C. Definition of diode switching characteristics

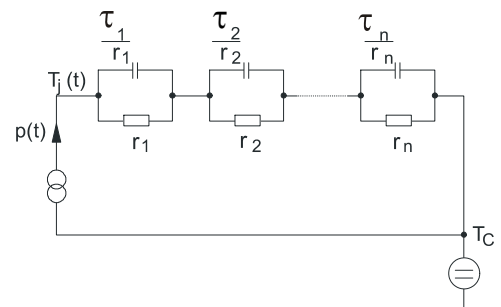

Figure D. Thermal equivalent circuit

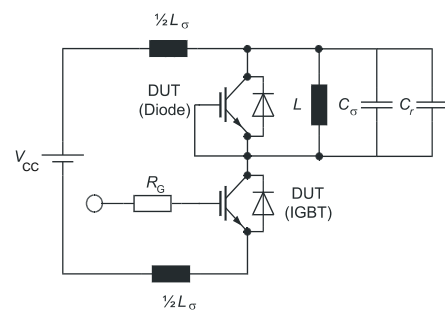

Figure E. Dynamic test circuit
Parasitic inductance L_σ ,
parasitic capacitor C_σ ,
relief capacitor C_r ,
(only for ZVT switching)

Revision History

IGW40N65H5A

Revision: 2014-12-15, Rev. 2.1

Previous Revision

Revision	Date	Subjects (major changes since last revision)
2.1	2014-12-15	Final data sheet

We Listen to Your Comments

Any information within this document that you feel is wrong, unclear or missing at all?

Your feedback will help us to continuously improve the quality of this document.

Please send your proposal (including a reference to this document) to: erratum@infineon.com

Published by

Infineon Technologies AG

81726 Munich, Germany

81726 München, Germany

© 2014 Infineon Technologies AG

All Rights Reserved.

Legal Disclaimer

The information given in this document shall in no event be regarded as a guarantee of conditions or characteristics.

With respect to any examples or hints given herein, any typical values stated herein and/or any information regarding the application of the device, Infineon Technologies hereby disclaims any and all warranties and liabilities of any kind, including without limitation, warranties of non-infringement of intellectual property rights of any third party.

Information

For further information on technology, delivery terms and conditions and prices, please contact the nearest Infineon Technologies Office (www.infineon.com).

Warnings

Due to technical requirements, components may contain dangerous substances. For information on the types in question, please contact the nearest Infineon Technologies Office.

The Infineon Technologies component described in this Data Sheet may be used in life-support devices or systems and/or automotive, aviation and aerospace applications or systems only with the express written approval of Infineon Technologies, if a failure of such components can reasonably be expected to cause the failure of that life-support, automotive, aviation and aerospace device or system or to affect the safety or effectiveness of that device or system. Life support devices or systems are intended to be implanted in the human body or to support and/or maintain and sustain and/or protect human life. If they fail, it is reasonable to assume that the health of the user or other persons may be endangered.