

INTERNATIONAL RECTIFIER

REPETITIVE AVALANCHE RATED AND dv/dt RATED

HEXFET[®] TRANSISTOR

IRFM150

2N7224

JANTX2N7224

JANTXV2N7224

[REF: MIL-S-19500/592]

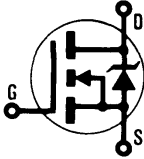

N-CHANNEL

100 Volt, 0.07 Ohm HEXFET

The HEXFET[®] technology is the key to International Rectifier's advanced line of power MOSFET transistors. The efficient geometry design achieves very low on-state resistance combined with high transconductance.

The HEXFET transistors also feature all of the well established advantages of MOSFETs such as voltage control, very fast switching, ease of paralleling and temperature stability of the electrical parameters.

They are well suited for applications such as switching power supplies and virtually any application where military and/or high reliability is required.

Product Summary

Part Number	BV_{DSS}	$R_{DS(on)}$	I_D
IRFM150	100V	0.07 Ω	34A

FEATURES:

- Repetitive Avalanche Rating
- Isolated and Hermetically Sealed
- Alternative to TO-3 Package
- Simple Drive Requirements
- Ease of Paralleling
- Ceramic Eyelets

CASE STYLE AND DIMENSIONS

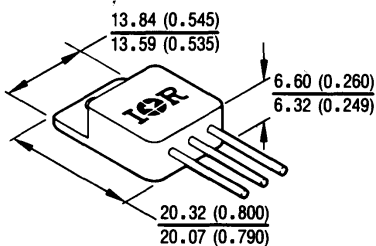

CAUTION

BERYLLIA WARNING PER MIL-S-19500
SEE PAGE I-308

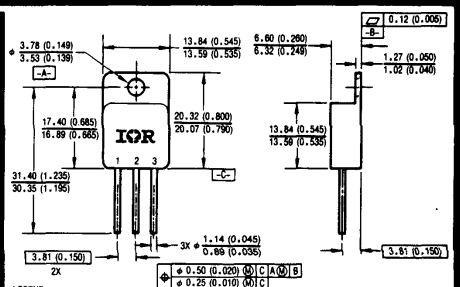

LEGEND

- 1 DRAIN
- 2 SOURCE
- 3 GATE

NOTES:

- 1 DIMENSIONING & TOLERANCING PER ANSI Y14.5M - 1982.
- 2 ALL DIMENSIONS ARE SHOWN IN MILLIMETERS (INCHES).

Conforms to JEDEC Outline TO-254AA*
Dimensions in Millimeters and (Inches)

*For leadform configurations see page I-308, fig. 15

Absolute Maximum Ratings

Parameter		IRFM150, JANTXV, JANTX, 2N7224	Units
I_D @ $V_{GS} = 10V, T_C = 25^\circ C$	Continuous Drain Current	34	A
I_D @ $V_{GS} = 10V, T_C = 100^\circ C$	Continuous Drain Current	21	
I_{DM}	Pulsed Drain Current ①	136	
P_D @ $T_C = 25^\circ C$	Max. Power Dissipation	150	W
	Linear Derating Factor	1.2	
V_{GS}	Gate-to-Source Voltage	± 20	V
E_{AS}	Single Pulse Avalanche Energy ②	150 (See Fig. 12)	mJ
I_{AR}	Avalanche Current ①	34 (See E_{AR})	A
E_{AR}	Repetitive Avalanche Energy ①	15 (See Fig. 13)	mJ
dv/dt	Peak Diode Recovery dv/dt ③	5.5 (See Fig. 13)	V/ns
T_J	Operating Junction	-55 to 150	$^\circ C$
T_{STG}	Storage Temperature Range		
	Lead Temperature		
	Weight	9.3 (typical)	g

Electrical Characteristics @ $T_J = 25^\circ C$ (Unless Otherwise Specified)

Parameter		Min.	Typ.	Max.	Units	Test Conditions	
BV_{DSS}	Drain-to-Source Breakdown Voltage	100	—	—	V	$V_{GS} = 0V, I_D = 1.0 \text{ mA}$	
$\Delta BV_{DSS}/\Delta T_J$	Temperature Coefficient of Breakdown Voltage	—	0.13	—	V/ $^\circ C$	Reference to $25^\circ C, I_D = 1.0 \text{ mA}$	
$R_{DS(on)}$	Static Drain-to-Source On-State Resistance	—	—	0.07	Ω	$V_{GS} = 10V, I_D = 21A$ ④	
		—	—	0.081		$V_{GS} = 10V, I_D = 34A$	
$V_{GS(th)}$	Gate Threshold Voltage	2.0	—	4.0	V	$V_{DS} = V_{GS}, I_D = 250 \mu A$	
g_{fs}	Forward Transconductance	9.0	—	—	S (①)	$V_{DS} \geq 15V, I_{DS} = 21A$ ④	
I_{DSS}	Zero Gate Voltage Drain Current	—	—	25	μA	$V_{DS} = 0.8 \times \text{Max. Rating}, V_{GS} = 0V$	
		—	—	250		$V_{DS} = 0.8 \times \text{Max. Rating}, V_{GS} = 0V, T_J = 125^\circ C$	
I_{GSS}	Gate-to-Source Leakage Forward	—	—	100	nA	$V_{GS} = 20V$	
I_{GSS}	Gate-to-Source Leakage Reverse	—	—	-100		$V_{GS} = -20V$	
Q_g	Total Gate Charge	50	—	125	nC	$V_{GS} = 10V, I_D = 34A$	
Q_{gs}	Gate-to-Source Charge	8	—	22		$V_{DS} = 0.5 \times \text{Max. Rating}$	
Q_{gd}	Gate-to-Drain ("Miller") Charge	15	—	65		See Fig. 6 and 14	
$t_{d(on)}$	Turn-On Delay Time	—	—	35	ns	$V_{DD} = 50V, I_D = 34A, R_G = 2.35\Omega$	
t_r	Rise Time	—	—	190		See Fig. 11	
$t_{d(off)}$	Turn-Off Delay Time	—	—	170			
t_f	Fall Time	—	—	130			
L_D	Internal Drain Inductance	—	8.7	—	nH	Measured from the drain lead, 6 mm (0.25 in.) from package to center of die.	Modified MOSFET symbol showing the internal inductances. 
L_S	Internal Source Inductance	—	8.7	—		Measured from the source lead, 6 mm (0.25 in.) from package to source bonding pad.	
C_{iss}	Input Capacitance	—	3700	—	pF	$V_{GS} = 0V, V_{DS} = 25V$	
C_{oss}	Output Capacitance	—	1100	—		$f = 1.0 \text{ MHz}$	
C_{rss}	Reverse Transfer Capacitance	—	200	—		See Fig. 5	
C_{DC}	Drain-to-Case Capacitance	—	12	—			



IRFM150, JANTXV, JANTX-, 2N7224 Devices

Source-Drain Diode Ratings and Characteristics

Parameter	Min.	Typ.	Max.	Units	Test Conditions
I_S Continuous Source Current (Body Diode)	—	—	34	A	Modified MOSFET symbol showing the integral Reverse p-n junction rectifier. 
I_{SM} Pulsed Source Current (Body Diode) ①	—	—	136		
V_{SD} Diode Forward Voltage	—	—	1.8	V	$T_J = 25^\circ\text{C}$, $I_S = 34\text{A}$, $V_{GS} = 0\text{V}$ ④
t_{rr} Reverse Recovery Time	—	—	500	nS	$T_J = 25^\circ\text{C}$, $I_F = 34\text{A}$, $di/dt \leq 100\text{ A}/\mu\text{s}$ ④
Q_{RR} Reverse Recovery Charge	—	—	2.9	μC	$V_{DD} \leq 50\text{V}$
t_{on} Forward Turn-On Time	Intrinsic turn-on time is negligible. Turn-on speed is substantially controlled by $L_S + L_D$.				

Thermal Resistance

Parameter	Min.	Typ.	Max.	Units	Test Conditions
R_{thJC} Junction-to-Case	—	—	0.83	K/W ⑤	Mounting surface flat, smooth, and greased
R_{thCS} Case-to-Sink	—	0.21	—		
R_{thJA} Junction-to-Ambient	—	—	48		Typical socket mount

① Repetitive Rating: Pulse width limited by maximum junction temperature (see figure 9)
Refer to current HEXFET reliability report

③ $I_{SD} \leq 34\text{A}$, $di/dt \leq 70\text{ A}/\mu\text{s}$,
 $V_{DD} \leq BV_{DSS}$, $T_J \leq 150^\circ\text{C}$
Suggested $R_G = 2.35\ \Omega$

⑤ $K/W = ^\circ\text{C}/W$
 $W/K = W/^\circ\text{C}$

④ $V_{DD} = 25\text{V}$, Starting $T_J = 25^\circ\text{C}$,
 $L \geq 200\ \mu\text{H}$, $R_G = 25\ \Omega$,
Peak $I_L = 34\text{A}$

④ Pulse width $\leq 300\ \mu\text{s}$; Duty Cycle $\leq 2\%$

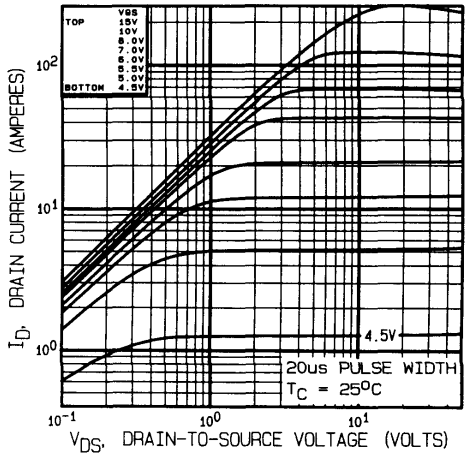

Fig. 1 — Typical Output Characteristics, $T_C = 25^\circ\text{C}$

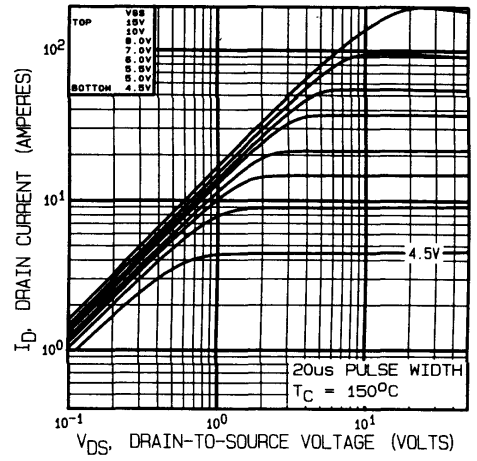

Fig. 2 — Typical Output Characteristics, $T_C = 150^\circ\text{C}$

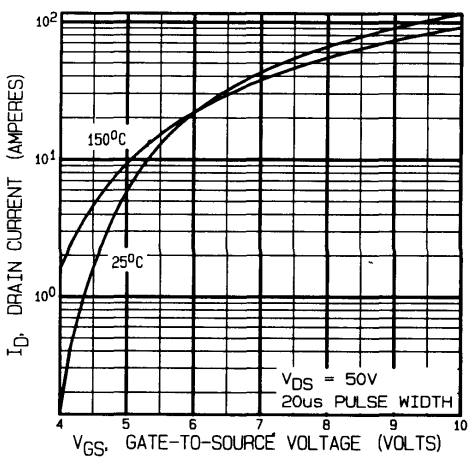

Fig. 3 — Typical Transfer Characteristics

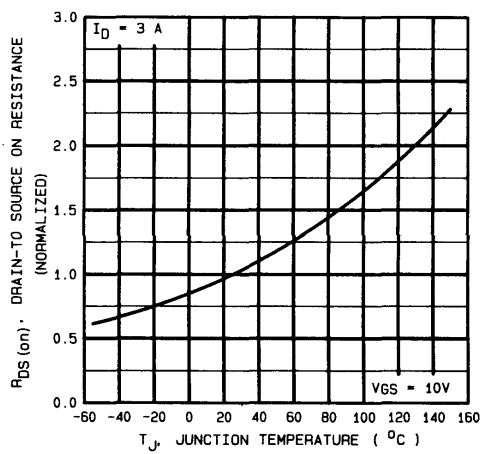
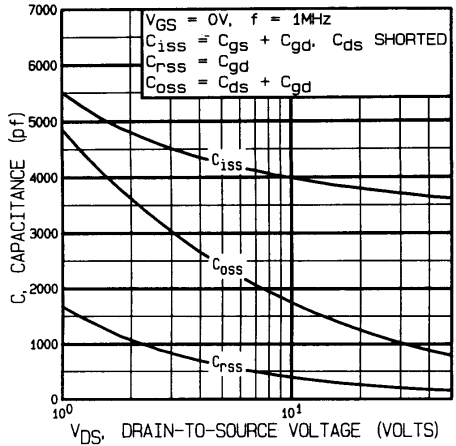
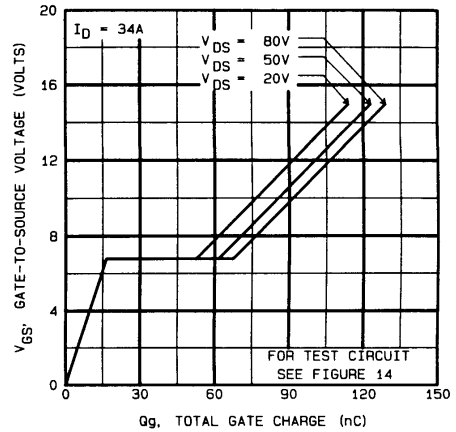
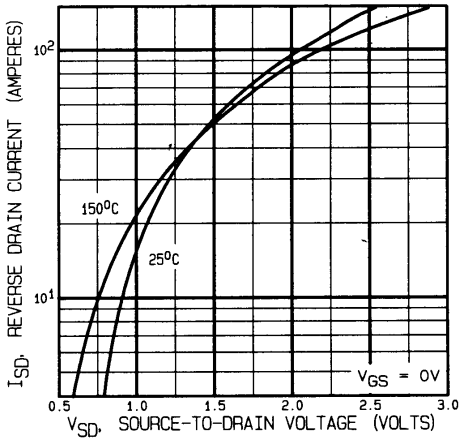
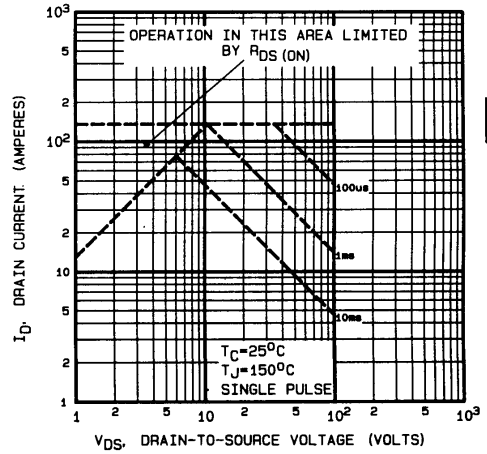

Fig. 4 — Normalized On-Resistance Vs. Temperature

Fig. 5 — Typical Capacitance Vs. Drain-to-Source Voltage

Fig. 6 — Typical Gate Charge Vs. Gate-to-Source Voltage

Fig. 7 — Typical Source-Drain Diode Forward Voltage

Fig. 8 — Maximum Safe Operating Area

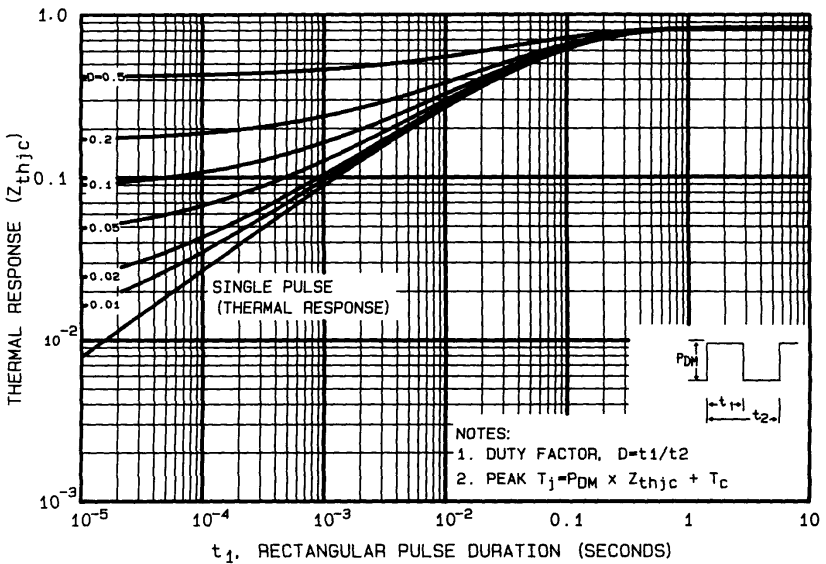

Fig. 9 — Maximum Effective Transient Thermal Impedance, Junction-to-Case Vs. Pulse Duration

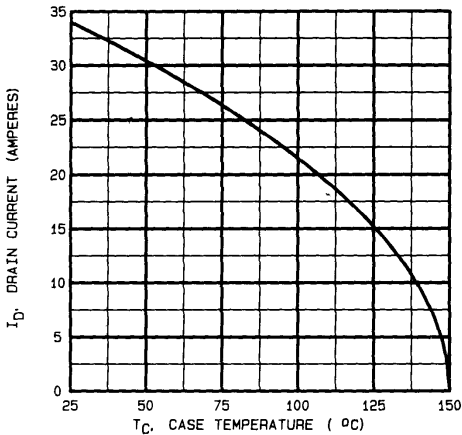

Fig. 10 — Maximum Drain Current Vs. Case Temperature

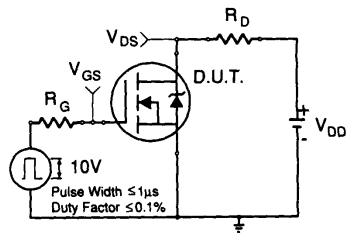

Fig. 11a — Switching Time Test Circuit

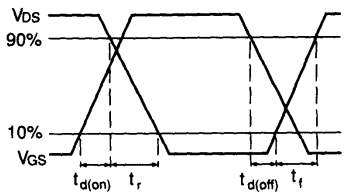

Fig. 11b — Switching Time Waveforms

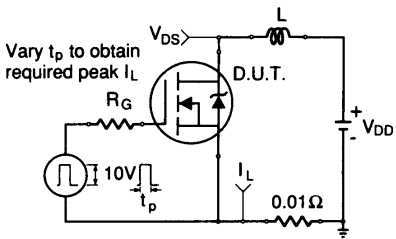

Fig. 12a — Unclamped Inductive Test Circuit

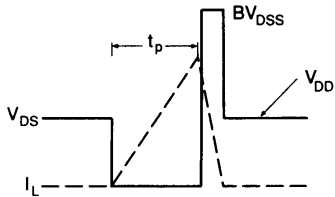

Fig. 12b — Unclamped Inductive Waveforms

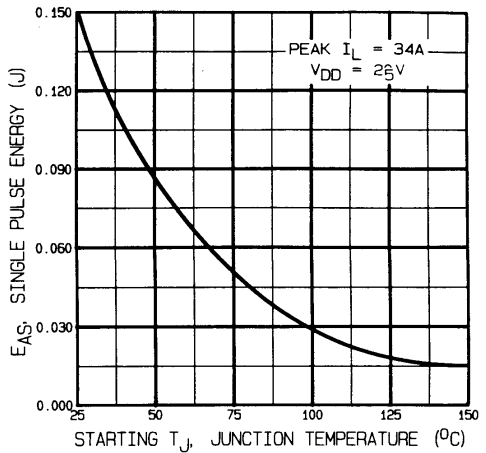

Fig. 12c — Maximum Avalanche Energy Vs. Starting Junction Temperature

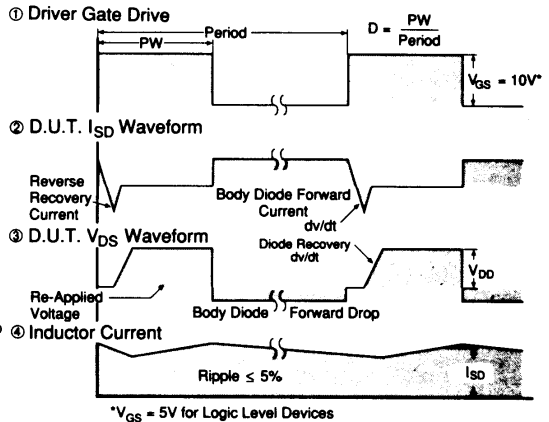
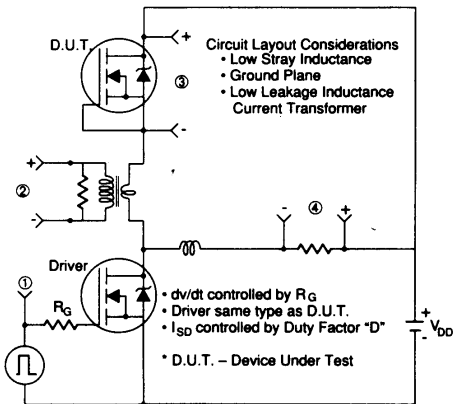

Fig. 13 — Peak Diode Recovery dv/dt Test Circuit

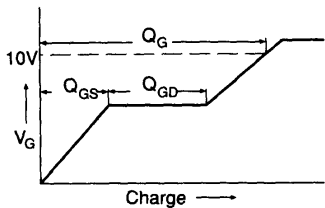

Fig. 14a — Basic Gate Charge Waveform

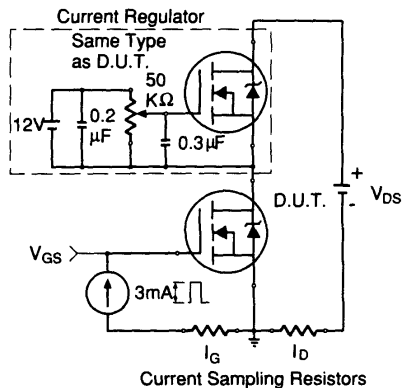

Fig. 14b — Gate Charge Test Circuit

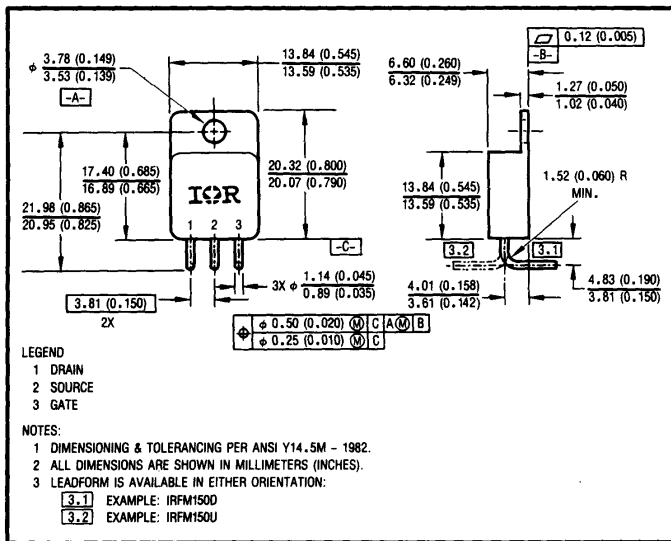

Fig. 15 — Optional Leadforms for Outline TO-254

BERYLLIA WARNING PER MIL-S-19500

Packages containing beryllia shall not be ground, sandblasted, machined, or have other operations performed on them which will produce beryllia or beryllium dust. Furthermore, beryllium oxide packages shall not be placed in acids that will produce fumes containing beryllium.