

V_{DS}	-30	V
$V_{GS\ max}$	±20	V
$R_{DS(on)\ max}$ (@ $V_{GS} = -10V$)	170	mΩ
I_D (@ $T_C = 25^\circ C$)	-3.4 ②	A

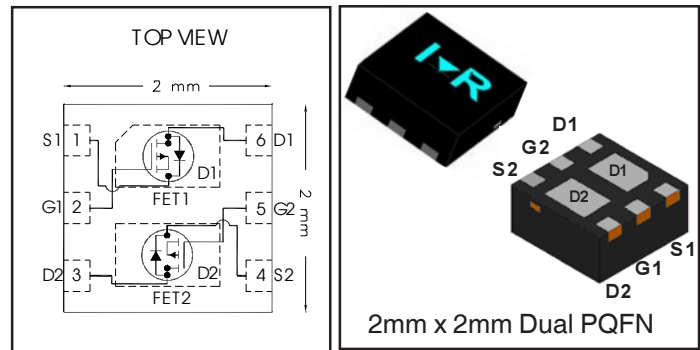

Applications

- Charge and Discharge Switch for Battery Application
- System/load switch

Features and Benefits

Features

Low $R_{DS(on)}$ ($\leq 170m\Omega$)
Low Thermal Resistance to PCB ($\leq 19^\circ C/W$)
Low Profile ($\leq 1.0\ mm$)
Compatible with Existing Surface Mount Techniques
RoHS Compliant Containing no Lead, no Bromide and no Halogen
MSL1, Industrial Qualification

results in

Benefits

Lower Conduction Losses
Enable better thermal dissipation
Increased Power Density
Easier Manufacturing
Environmentally Friendlier
Increased Reliability

Orderable part number	Package Type	Standard Pack		Note
		Form	Quantity	
IRFHS9351TRPBF	PQFN 2mm x 2mm	Tape and Reel	4000	
IRFHS9351TR2PBF	PQFN 2mm x 2mm	Tape and Reel	400	EOL notice # 259

Absolute Maximum Ratings

	Parameter	Max.	Units
V_{DS}	Drain-to-Source Voltage	-30	V
V_{GS}	Gate-to-Source Voltage	± 20	
I_D @ $T_A = 25^\circ C$	Continuous Drain Current, V_{GS} @ -10V	-2.3	A
I_D @ $T_A = 70^\circ C$	Continuous Drain Current, V_{GS} @ -10V	-1.5	
I_D @ $T_C = 25^\circ C$	Continuous Drain Current, V_{GS} @ -10V	-5.1 ②	
I_D @ $T_C = 70^\circ C$	Continuous Drain Current, V_{GS} @ -10V	-4.1 ②	
I_D @ $T_C = 25^\circ C$	Continuous Drain Current, V_{GS} @ 10V (Package Limited)	-3.4 ②	
I_{DM}	Pulsed Drain Current ①	-20	
P_D @ $T_A = 25^\circ C$	Power Dissipation ④	1.4	W
P_D @ $T_A = 70^\circ C$	Power Dissipation ④	0.9	
	Linear Derating Factor	0.01	W/°C
T_J T_{STG}	Operating Junction and Storage Temperature Range	-55 to + 150	°C

Notes ① through ⑥ are on page 2

Static @ T_J = 25°C (unless otherwise specified)

	Parameter	Min.	Typ.	Max.	Units	Conditions
BV _{DSS}	Drain-to-Source Breakdown Voltage	-30	—	—	V	V _{GS} = 0V, I _D = -250μA
V _{DSS} / T _J	Breakdown Voltage Temp. Coefficient	—	0.02	—	V/°C	Reference to 25°C, I _D = -1mA
R _{DS(on)}	Static Drain-to-Source On-Resistance	—	135	170	m	V _{GS} = -10V, I _D = -3.1A ③
		—	235	290		V _{GS} = -4.5V, I _D = -2.5A ③
V _{GS(th)}	Gate Threshold Voltage	-1.3	-1.8	-2.4	V	V _{DS} = V _{GS} , I _D = -10μA
V _{GS(th)}	Gate Threshold Voltage Coefficient	—	-4.6	—	mV/°C	
I _{DSS}	Drain-to-Source Leakage Current	—	—	-1.0	μA	V _{DS} = -24V, V _{GS} = 0V
		—	—	-150		V _{DS} = -24V, V _{GS} = 0V, T _J = 125°C
I _{GSS}	Gate-to-Source Forward Leakage	—	—	-100	nA	V _{GS} = -20V
	Gate-to-Source Reverse Leakage	—	—	100		V _{GS} = 20V
g _{fs}	Forward Transconductance	2.4	—	—	S	V _{DS} = -10V, I _D = -3.1A
Q _g	Total Gate Charge ⑥	—	1.9	—	nC	V _{DS} = -15V, V _{GS} = -4.5V, I _D = -3.1A
Q _g	Total Gate Charge ⑥	—	3.7	—	nC	V _{GS} = -10V
Q _{gs}	Gate-to-Source Charge ⑥	—	0.6	—		V _{DS} = -15V
Q _{gd}	Gate-to-Drain Charge ⑥	—	1.1	—		I _D = -3.1A
R _G	Gate Resistance ⑥	—	17	—		
t _{d(on)}	Turn-On Delay Time	—	8.3	—	ns	V _{DD} = -15V, V _{GS} = -4.5V ③
t _r	Rise Time	—	30	—		I _D = -3.1A
t _{d(off)}	Turn-Off Delay Time	—	6.3	—		R _G = 1.8
t _f	Fall Time	—	7.9	—		See Figs. 19a & 19b
C _{iss}	Input Capacitance	—	160	—	pF	V _{GS} = 0V
C _{oss}	Output Capacitance	—	39	—		V _{DS} = -25V
C _{rss}	Reverse Transfer Capacitance	—	26	—		f = 1.0KHz

Diode Characteristics

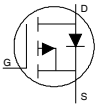
	Parameter	Min.	Typ.	Max.	Units	Conditions
I _S	Continuous Source Current (Body Diode)	—	—	-5.1	A	MOSFET symbol showing the integral reverse p-n junction diode. 
I _{SM}	Pulsed Source Current (Body Diode) ①	—	—	-20		
V _{SD}	Diode Forward Voltage	—	—	-1.2	V	T _J = 25°C, I _S = -3.1A, V _{GS} = 0V ③
t _{rr}	Reverse Recovery Time	—	20	30	ns	T _J = 25°C, I _F = -3.1A, V _{DD} = -15V
Q _{rr}	Reverse Recovery Charge	—	42	63	nC	di/dt = 370/μs ③

Thermal Resistance

	Parameter	Typ.	Max.	Units
R _{JC} (Bottom)	Junction-to-Case ②	—	19	°C/W
R _{JC} (Top)	Junction-to-Case ②	—	170	
R _{JA}	Junction-to-Ambient ④	—	90	
R _{JA}	Junction-to-Ambient (t<10s) ④	—	75	

Notes:

- ① Repetitive rating; pulse width limited by max. junction temperature.
- ② Current limited by package. .
- ③ Pulse width ≤ 400μs; duty cycle ≤ 2%.
- ④ When mounted on 1 inch square copper board.
- ⑤ R_θ is measured at T_J of approximately 90°C.
- ⑥ For DESIGN AID ONLY, not subject to production testing.

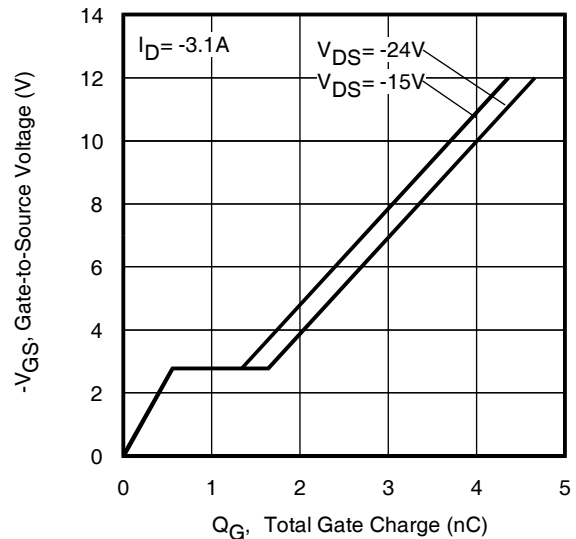
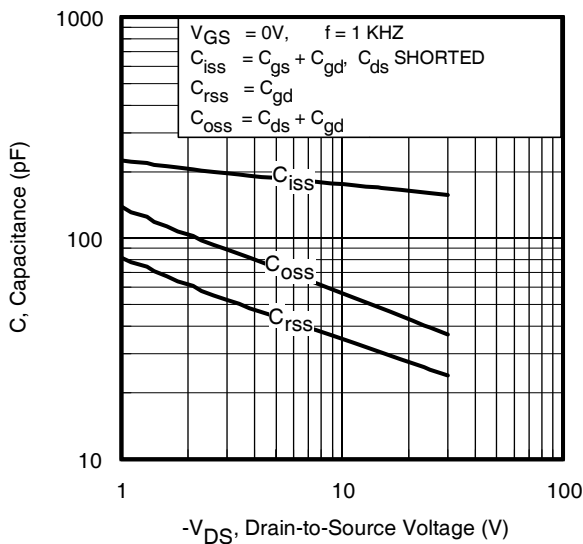
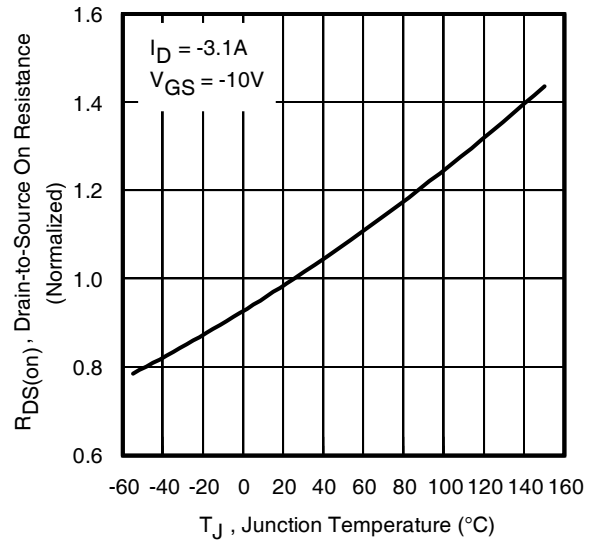
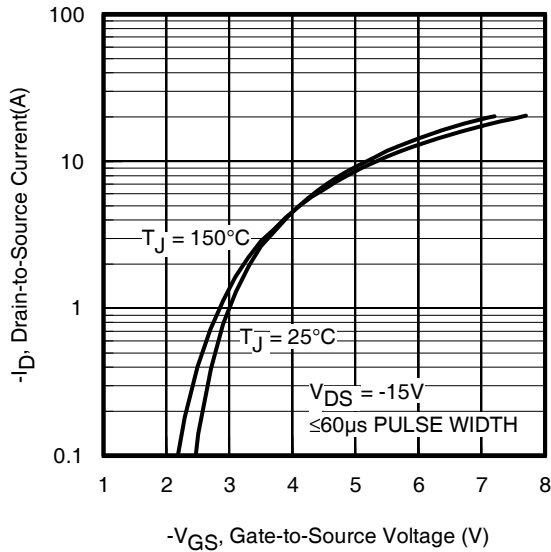
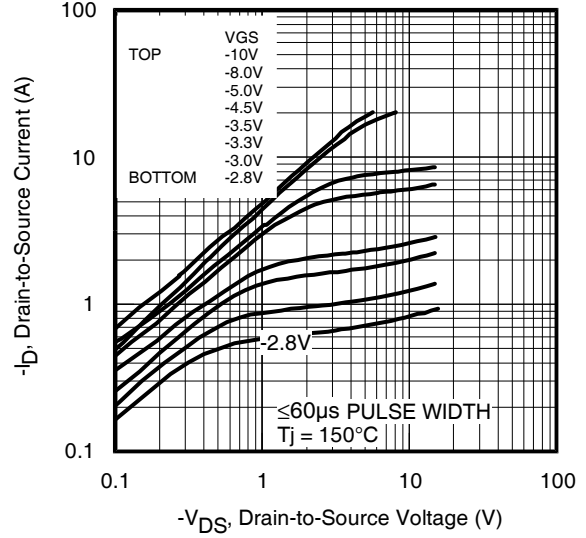
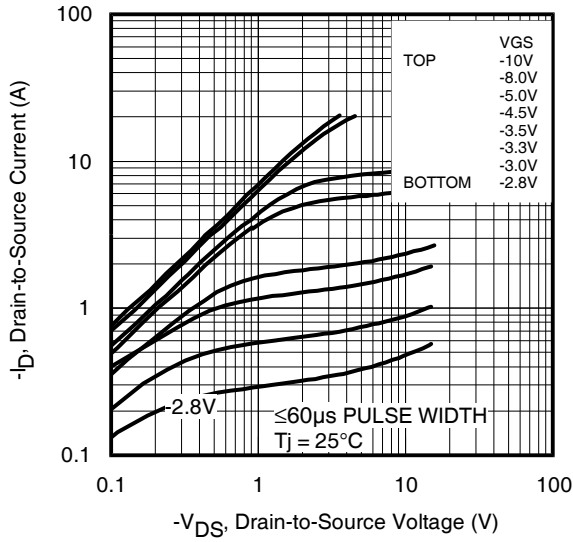
Fig 5. Typical Capacitance vs. Drain-to-Source Voltage
Fig 6. Typical Gate Charge vs. Gate-to-Source Voltage

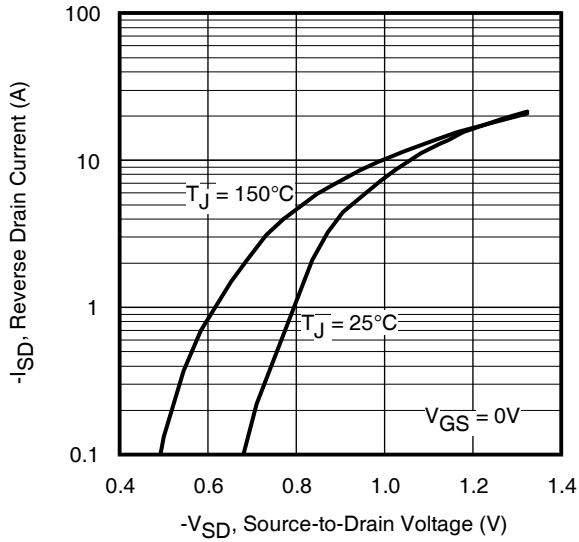
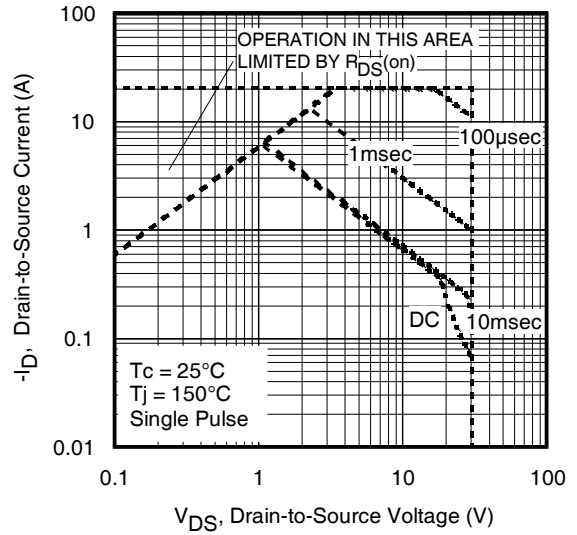
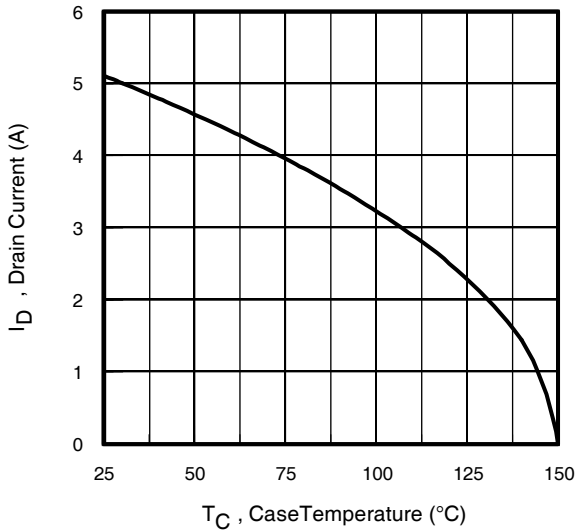
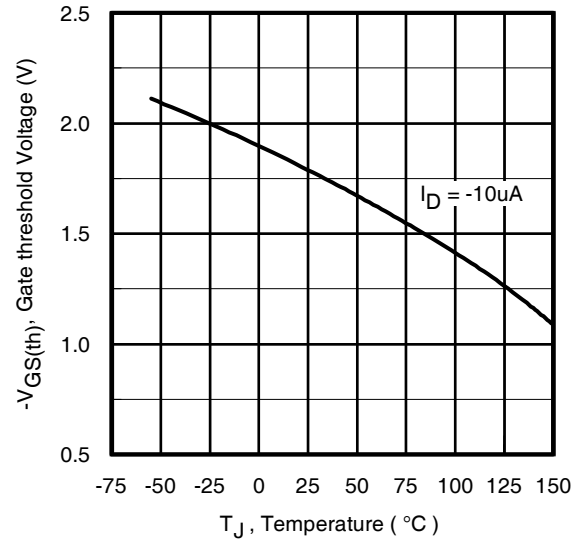
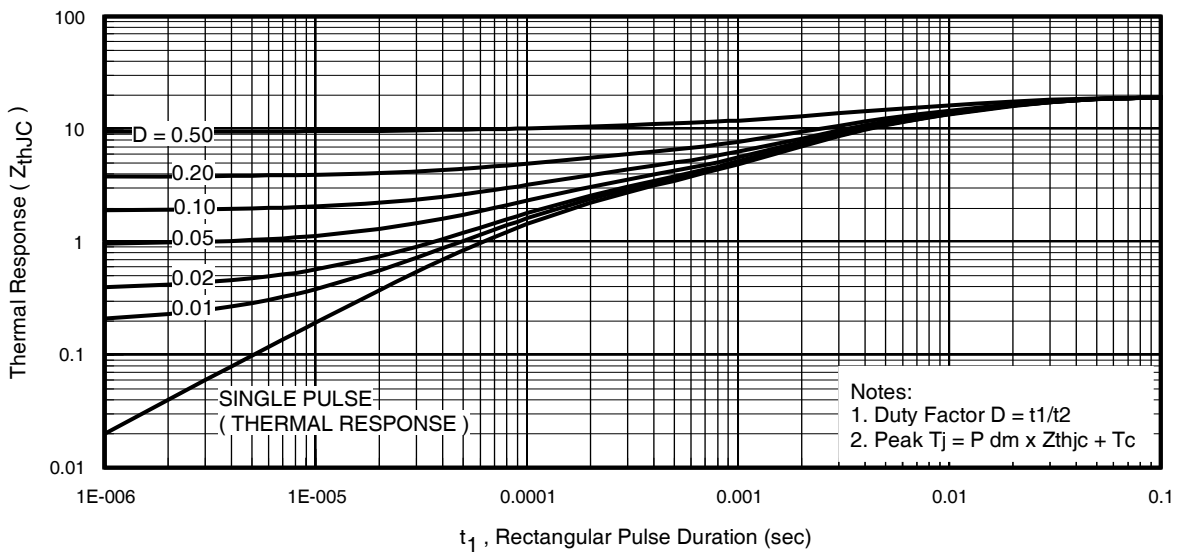
Fig 7. Typical Source-Drain Diode Forward Voltage

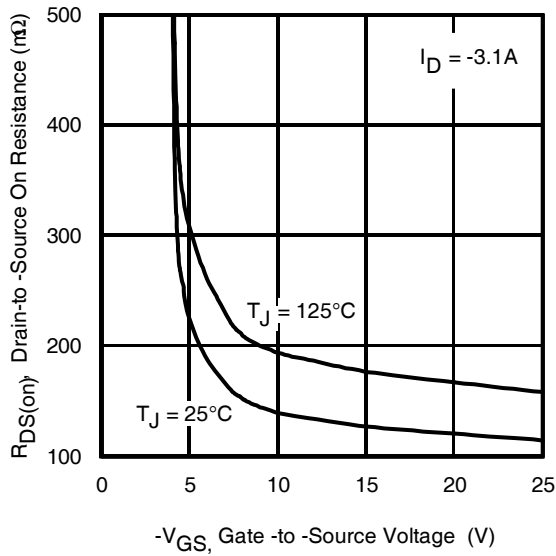
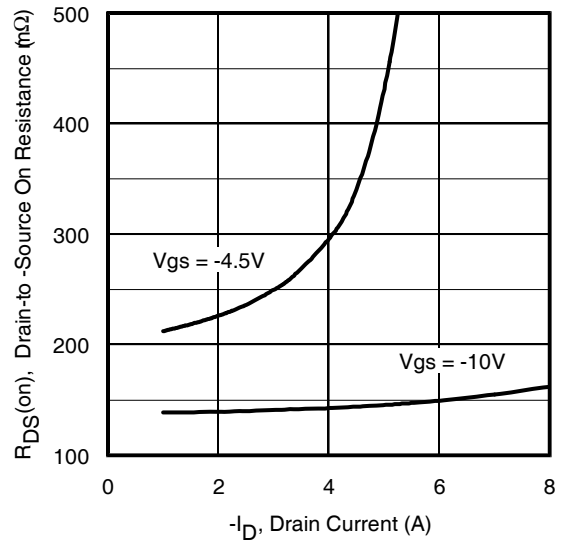
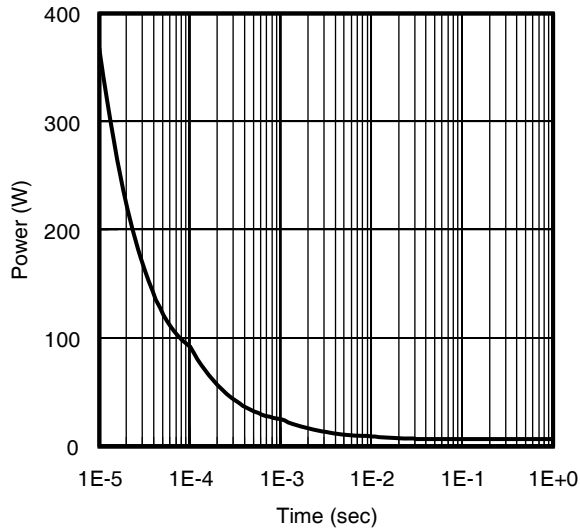
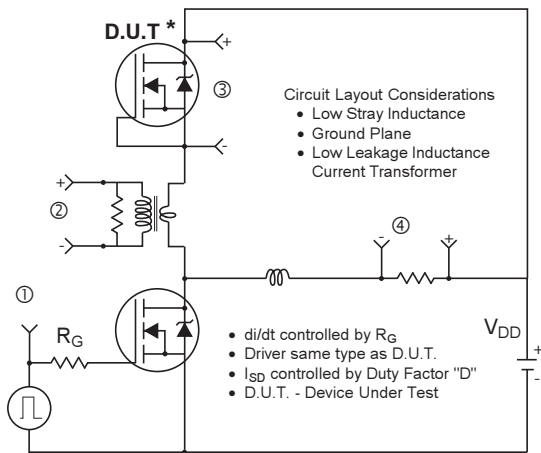
Fig 8. Maximum Safe Operating Area

Fig 9. Maximum Drain Current vs. Case Temperature

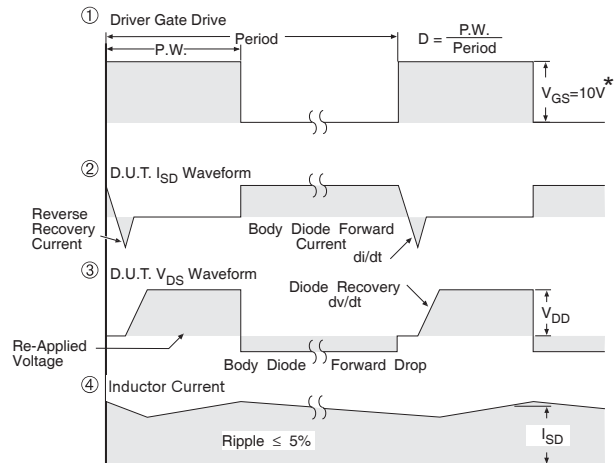
Fig 10. Threshold Voltage vs. Temperature

Fig 11. Maximum Effective Transient Thermal Impedance, Junction-to-Case

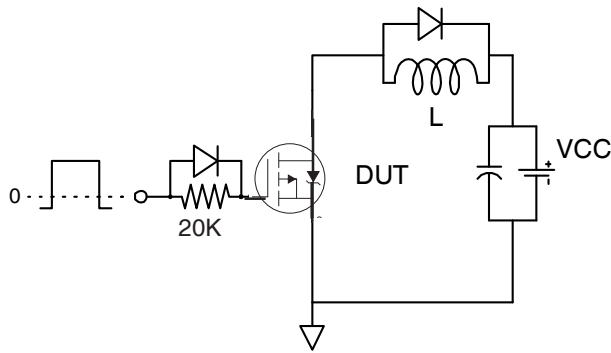
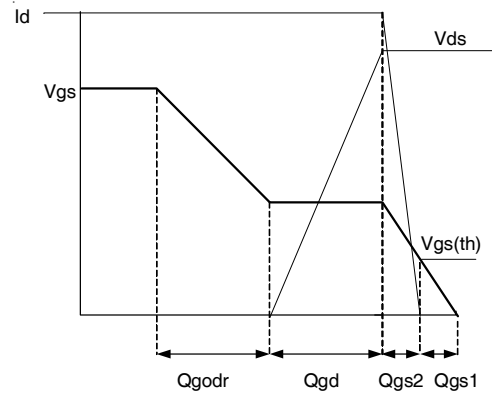
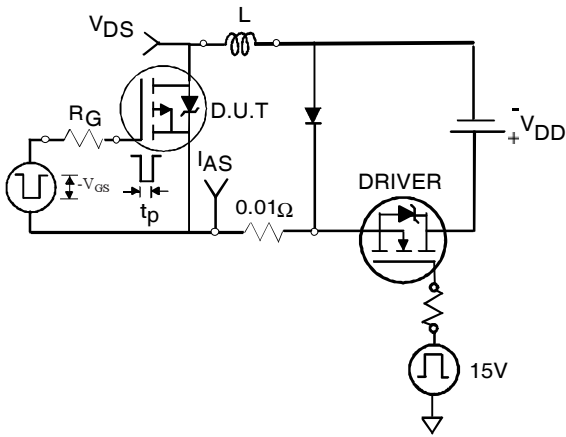
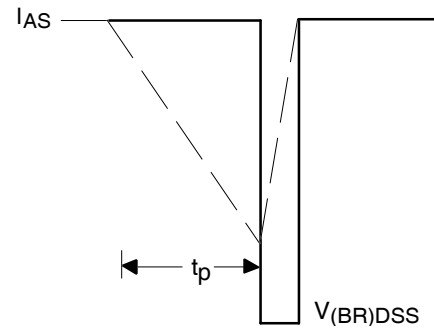
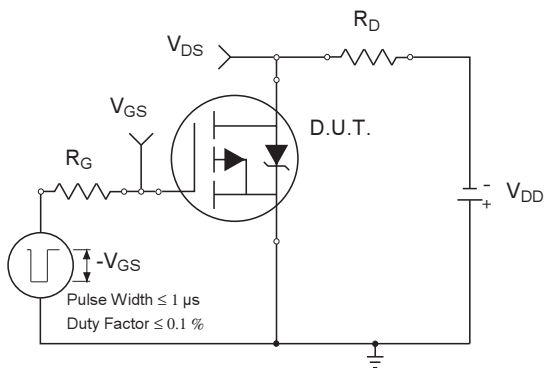
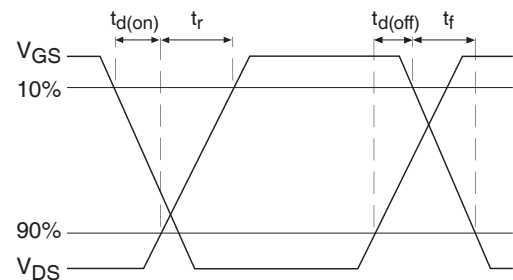

Fig 12. On-Resistance vs. Gate Voltage

Fig 13. Typical On-Resistance vs. Drain Current

Fig 14. Typical Power vs. Time

* Reverse Polarity of D.U.T. for P-Channel



* $V_{GS} = 5V$ for Logic Level Devices

Fig 15. Diode Reverse Recovery Test Circuit for P-Channel HEXFET® Power MOSFETs

Fig 16a. Gate Charge Test Circuit

Fig 16b. Gate Charge Waveform

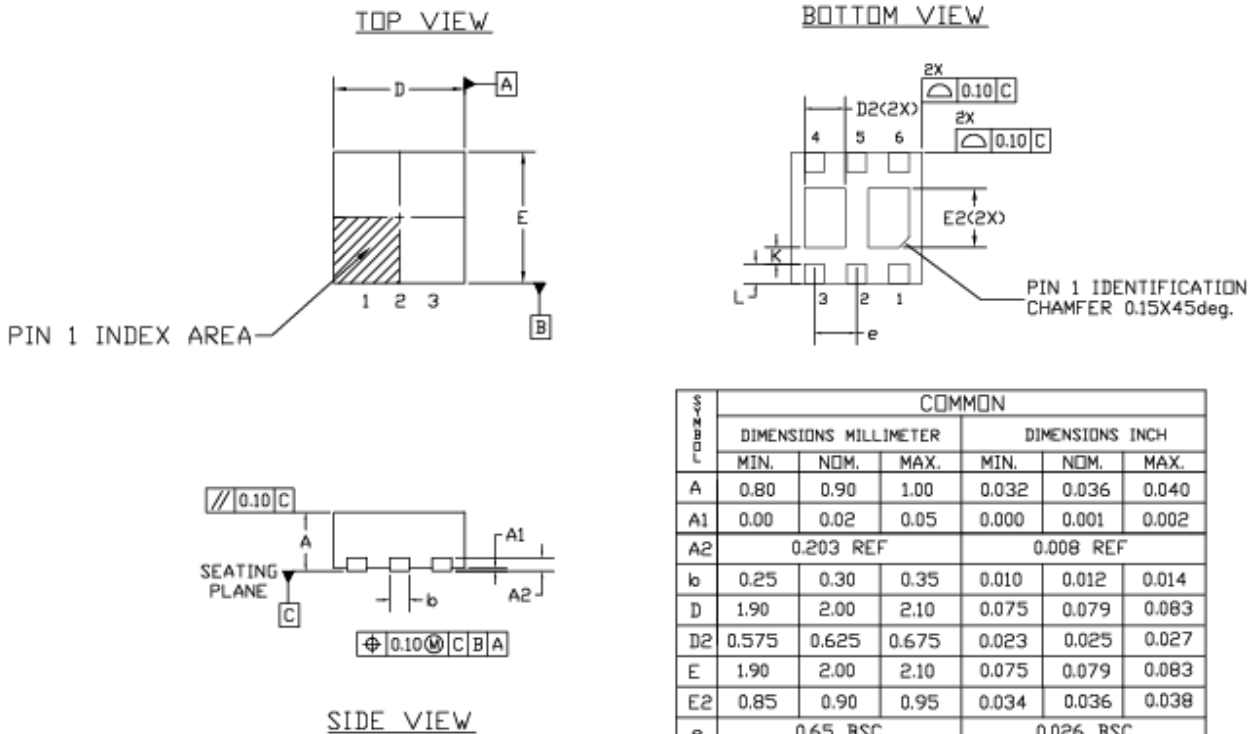
Fig 17a. Unclamped Inductive Test Circuit

Fig 17b. Unclamped Inductive Waveforms

Fig 18a. Switching Time Test Circuit

Fig 18b. Switching Time Waveforms

PQFN Package Details



SYMBOL	COMMON					
	DIMENSIONS MILLIMETER			DIMENSIONS INCH		
	MIN.	NOM.	MAX.	MIN.	NOM.	MAX.
A	0.80	0.90	1.00	0.032	0.036	0.040
A1	0.00	0.02	0.05	0.000	0.001	0.002
A2	0.203 REF			0.008 REF		
b	0.25	0.30	0.35	0.010	0.012	0.014
D	1.90	2.00	2.10	0.075	0.079	0.083
D2	0.575	0.625	0.675	0.023	0.025	0.027
E	1.90	2.00	2.10	0.075	0.079	0.083
E2	0.85	0.90	0.95	0.034	0.036	0.038
e	0.65 BSC			0.026 BSC		
L	0.25	0.30	0.35	0.010	0.012	0.014
K	0.25	-	-	0.010	-	-

NOTES :

1. DIMENSION AND TOLERANCING CONFORM TO ASME Y14.5M-1994.
2. CONTROLLING DIMENSIONS : MILLIMETER. CONVERTED INCH DIMENSION ARE NOT NECESSARILY EXACT.

PQFN Part Marking

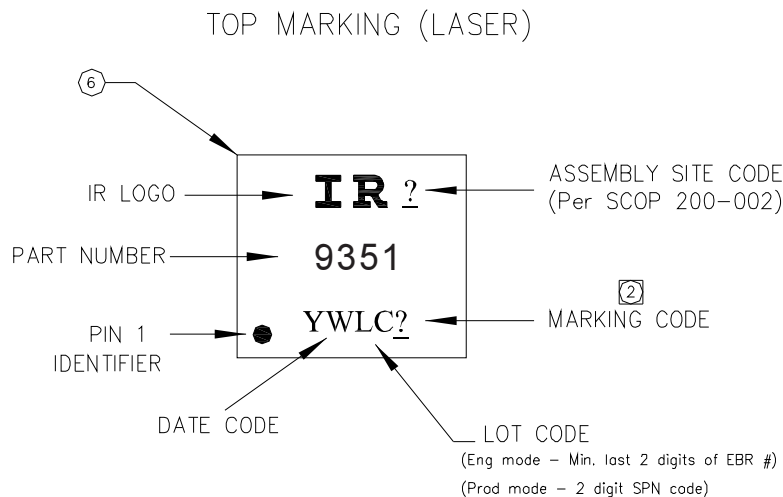

Note: For the most current drawing please refer to IR website at: <http://www.irf.com/package/>

PQFN Tape and Reel

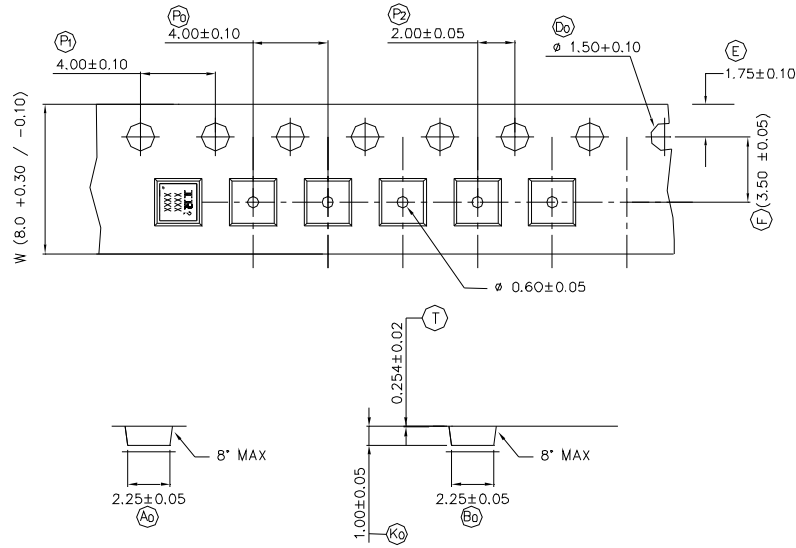

NOTE: The Surface Resistivity is $10^4 - 10^8$ OHM/SQ

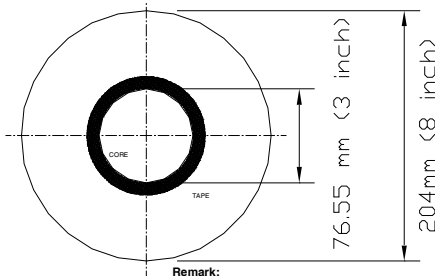
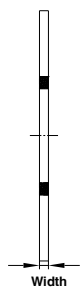

Remark:
 - Dimension above are typical dimensions.
 - Cover tape thickness is 0.043mm +/- 0.005mm.
 - Surface resistivity $10E5 < R_s < 10E8$.

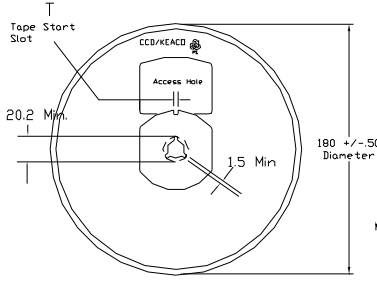

FRONT VIEW

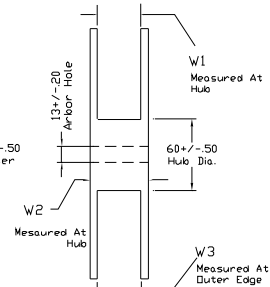

SIDE VIEW

COVER TAPE (WIDTH)	TOLERANCE
5.4 mm	+/- 0.1 mm
9.5 mm	+/- 0.1 mm

TAPE WIDTH	T	W1	W2	W3	PART NO
8 MM	3 ± 0.50	8.4 ^{+1.5} _{-0.0}	14.4 Max	7.90 Min 10.9 Max	91586-1
12 MM	3 ± 0.50	12.4 ^{+2.0} _{-0.0}	18.4 Max	11.9 Min 15.4 Max	91586-2

Note: Surface resistivity is $\geq 1 \times 10^5$ but $< 1 \times 10^{12}$ ohm/sq.

Note: For the most current drawing please refer to IR website at: <http://www.irf.com/package/>

Qualification information[†]

Qualification level	Industrial ^{††} (per JEDEC JESD47F ^{†††} guidelines)	
Moisture Sensitivity Level	PQFN 2mm x 2mm	MSL1 (per IPC/JEDEC J-STD-020D ^{†††})
RoHS compliant	Yes	

† Qualification standards can be found at International Rectifier's web site

<http://www.irf.com/product-info/reliability>

†† Higher qualification ratings may be available should the user have such requirements.

Please contact your International Rectifier sales representative for further information:

<http://www.irf.com/whoto-call/salesrep/>

††† Applicable version of JEDEC standard at the time of product release.

Revision History

Date	Comment
5/13/2014	<ul style="list-style-type: none"> • Updated ordering information to reflect the End-Of-life (EOL) of the mini-reel option (EOL notice #259) • Updated data sheet based on corporate template.
5/21/2014	<ul style="list-style-type: none"> • Updated qual level from "Consumer" to "Industrial" on page 1 & 9.

IMPORTANT NOTICE

The information given in this document shall in no event be regarded as a guarantee of conditions or characteristics ("Beschaffheitsgarantie").

With respect to any examples, hints or any typical values stated herein and/or any information regarding the application of the product, Infineon Technologies hereby disclaims any and all warranties and liabilities of any kind, including without limitation warranties of non-infringement of intellectual property rights of any third party.

In addition, any information given in this document is subject to customer's compliance with its obligations stated in this document and any applicable legal requirements, norms and standards concerning customer's products and any use of the product of Infineon Technologies in customer's applications.

The data contained in this document is exclusively intended for technically trained staff. It is the responsibility of customer's technical departments to evaluate the suitability of the product for the intended application and the completeness of the product information given in this document with respect to such application.

For further information on the product, technology, delivery terms and conditions and prices please contact your nearest Infineon Technologies office (www.infineon.com).

WARNINGS

Due to technical requirements products may contain dangerous substances. For information on the types in question please contact your nearest Infineon Technologies office.

Except as otherwise explicitly approved by Infineon Technologies in a written document signed by authorized representatives of Infineon Technologies, Infineon Technologies' products may not be used in any applications where a failure of the product or any consequences of the use thereof can reasonably be expected to result in personal injury.