

# MOSFET

Metal Oxide Semiconductor Field Effect Transistor

## CoolMOS™ C6 650V

650V CoolMOS™ C6 Power Transistor  
IPD65R1K4C6

## Data Sheet

Rev. 2.1  
Final

Industrial & Multimarket

## 1 Description

CoolMOS™ is a revolutionary technology for high voltage power MOSFETs, designed according to the superjunction (SJ) principle and pioneered by Infineon Technologies. CoolMOS™ C6 series combines the experience of the leading SJ MOSFET supplier with high class innovation. The resulting devices provide all benefits of a fast switching SJ MOSFET while not sacrificing ease of use. Extremely low switching and conduction losses make switching applications even more efficient, more compact, lighter and cooler.

## Features

- Extremely low losses due to very low FOM  $R_{ds(on)} \cdot Q_g$  and  $E_{oss}$
- Very high commutation ruggedness
- Easy to use/drive
- Pb-free plating, Halogen free mold compound
- Fully qualified according to JEDEC for Industrial Applications

## Applications

Hard switching PWM stages and resonant switching PWM stages for e.g. PC Silverbox, Adapter, LCD & PDP TV and Lighting.

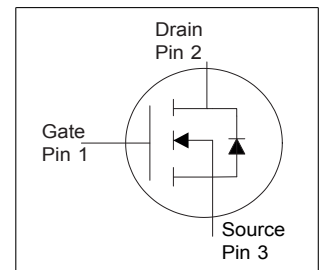
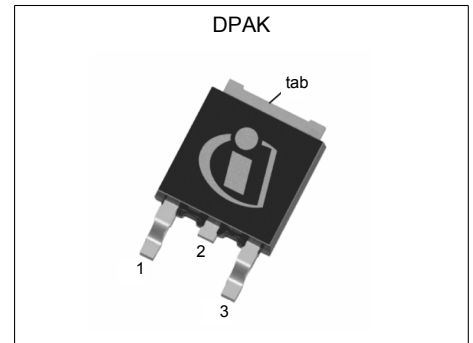

**Table 1 Key Performance Parameters**

Parameter	Value	Unit
$V_{DS} @ T_{j,max}$	700	V
$R_{DS(on),max}$	1.4	$\Omega$
$Q_g,typ$	10.5	nC
$I_D,pulse$	8.3	A
$E_{oss} @ 400V$	1.15	$\mu J$
Body diode $di/dt$	500	A/ $\mu s$

Type / Ordering Code	Package	Marking	Related Links
IPD65R1K4C6	PG-TO 252	65C61K4	see Appendix A



**Table of Contents**

Description ..... 2

Table of Contents ..... 3

Maximum ratings ..... 4

Thermal characteristics ..... 5

Electrical characteristics ..... 6

Electrical characteristics diagrams ..... 8

Test Circuits ..... 12

Package Outlines ..... 13

Appendix A ..... 14

Revision History ..... 15

Disclaimer ..... 15

## 2 Maximum ratings

at  $T_j = 25^\circ\text{C}$ , unless otherwise specified

**Table 2 Maximum ratings**

Parameter	Symbol	Values			Unit	Note / Test Condition
		Min.	Typ.	Max.		
Continuous drain current <sup>1)</sup>	$I_D$			3.2	A	$T_C = 25^\circ\text{C}$
				2.0		$T_C = 100^\circ\text{C}$
Pulsed drain current <sup>2)</sup>	$I_{D,pulse}$			8.3	A	$T_C = 25^\circ\text{C}$
Avalanche energy, single pulse	$E_{AS}$			26	mJ	$I_D = 0.6\text{A}$ , $V_{DD} = 50\text{V}$ (see table 10)
Avalanche energy, repetitive	$E_{AR}$			0.10	mJ	$I_D = 0.6\text{A}$ , $V_{DD} = 50\text{V}$
Avalanche current, repetitive	$I_{AR}$			0.6	A	
MOSFET dv/dt ruggedness	dv/dt			50	V/ns	$V_{DS} = 0 \dots 480\text{V}$
Gate source voltage	$V_{GS}$	-20		20	V	static
		-30		30		AC ( $f > 1\text{ Hz}$ )
Operating and storage temperature	$T_j, T_{stg}$	-55		150	$^\circ\text{C}$	
Continuous diode forward current	$I_S$			2.8	A	$T_C = 25^\circ\text{C}$
Diode pulse current	$I_{S,pulse}$			8.3	A	$T_C = 25^\circ\text{C}$
Reverse diode dv/dt <sup>3)</sup>	dv/dt			15	V/ns	$V_{DS} = 0 \dots 400\text{V}$ , $I_{SD} \leq I_D$ , $T_j = 25^\circ\text{C}$ (see table 8)
Maximum diode commutation speed	di/dt			500	A/ $\mu\text{s}$	
Power dissipation	$P_{tot}$			28	W	$T_C = 25^\circ\text{C}$

<sup>1)</sup> Limited by  $T_{j,max}$ . Maximum duty cycle  $D=0.75$

<sup>2)</sup> Pulse width  $t_p$  limited by  $T_{j,max}$

<sup>3)</sup> Identical low side and high side switch with identical  $R_G$

### 3 Thermal characteristics

**Table 3 Thermal characteristics DPAK**

Parameter	Symbol	Values			Unit	Note / Test Condition
		Min.	Typ.	Max.		
Thermal resistance, junction - case	$R_{thJC}$			4.4	°C/W	
Thermal resistance, junction - ambient <sup>1)</sup>	$R_{thJA}$			62	°C/W	leaded
			35			SMD version, device on PCB, 6cm <sup>2</sup> cooling area
Soldering temperature, wave- & reflowsoldering allowed	$T_{sold}$			260	°C	1.6 mm (0.063 in.) from case for 10s

<sup>1)</sup> Device on 40mm\*40mm\*1.5mm one layer epoxy PCB FR4 with 6cm<sup>2</sup> copper area (thickness 70µm) for drain connection. PCB is vertical without air stream cooling.

## 4 Electrical characteristics

at  $T_j = 25^\circ\text{C}$ , unless otherwise specified

**Table 4 Static characteristics**

Parameter	Symbol	Values			Unit	Note / Test Condition
		Min.	Typ.	Max.		
Drain-source breakdown voltage	$V_{(BR)DSS}$	650			V	$V_{GS} = 0V, I_D = 1mA$
Gate threshold voltage	$V_{GS(th)}$	2.5	3	3.5	V	$V_{DS} = V_{GS}, I_D = 0.1mA$
Zero gate voltage drain current	$I_{DSS}$			1	$\mu A$	$V_{DS} = 650V, V_{GS} = 0V, T_j = 25^\circ C$
			10			$V_{DS} = 650V, V_{GS} = 0V, T_j = 150^\circ C$
Gate-source leakage current	$I_{GSS}$			100	nA	$V_{GS} = 20V, V_{DS} = 0V$
Drain-source on-state resistance	$R_{DS(on)}$		1.260	1.4	$\Omega$	$V_{GS} = 10V, I_D = 1.0A, T_j = 25^\circ C$
			3.280			$V_{GS} = 10V, I_D = 1A, T_j = 150^\circ C$
Gate resistance	$R_G$		6.5		$\Omega$	$f = 1MHz, \text{open drain}$

**Table 5 Dynamic characteristics**

Parameter	Symbol	Values			Unit	Note / Test Condition
		Min.	Typ.	Max.		
Input capacitance	$C_{iss}$		225		pF	$V_{GS} = 0V, V_{DS} = 100V, f = 1MHz$
Output capacitance	$C_{oss}$		18		pF	
Effective output capacitance, energy related <sup>1)</sup>	$C_{o(er)}$		10		pF	$V_{GS} = 0V, V_{DS} = 0 \dots 480V$
Effective output capacitance, time related <sup>2)</sup>	$C_{o(tr)}$		42		pF	$I_D = \text{constant}, V_{GS} = 0V, V_{DS} = 0 \dots 480V$
Turn-on delay time	$t_{d(on)}$		7.7		ns	$V_{DD} = 400V, V_{GS} = 13V, I_D = 1.5A, R_G = 10.2\Omega$ (see table 9)
Rise time	$t_r$		5.9		ns	
Turn-off delay time	$t_{d(off)}$		33		ns	
Fall time	$t_f$		18.2		ns	

**Table 6 Gate charge characteristics**

Parameter	Symbol	Values			Unit	Note / Test Condition
		Min.	Typ.	Max.		
Gate to source charge	$Q_{gs}$		1.3		nC	$V_{DD} = 480V, I_D = 1.5A, V_{GS} = 0 \text{ to } 10V$
Gate to drain charge	$Q_{gd}$		5.8		nC	
Gate charge total	$Q_g$		10.5		nC	
Gate plateau voltage	$V_{plateau}$		5.4		V	

<sup>1)</sup>  $C_{o(er)}$  is a fixed capacitance that gives the same stored energy as  $C_{oss}$  while  $V_{DS}$  is rising from 0 to 80%  $V_{(BR)DSS}$

<sup>2)</sup>  $C_{o(tr)}$  is a fixed capacitance that gives the same charging time as  $C_{oss}$  while  $V_{DS}$  is rising from 0 to 80%  $V_{(BR)DSS}$

**Table 7 Reverse diode characteristics**

Parameter	Symbol	Values			Unit	Note / Test Condition
		Min.	Typ.	Max.		
Diode forward voltage	$V_{SD}$		0.9		V	$V_{GS} = 0V, I_F = 1.5A, T_j = 25^\circ C$
Reverse recovery time	$t_{rr}$		200		ns	$V_R = 400V, I_F = 1.5A,$ $di_F/dt = 100A/\mu s$ (see table 8)
Reverse recovery charge	$Q_{rr}$		0.9		$\mu C$	
Peak reverse recovery current	$I_{rrm}$		8		A	

### 5 Electrical characteristics diagrams

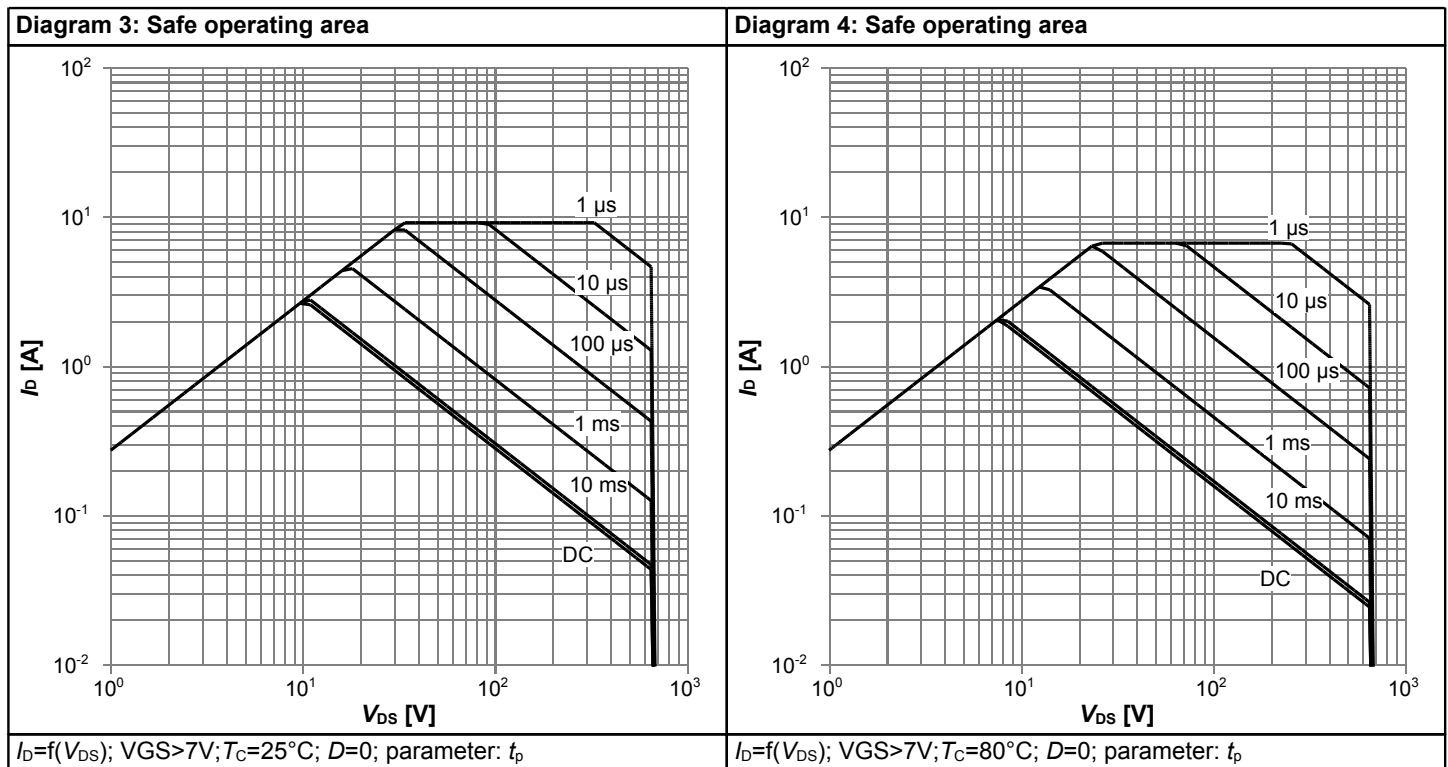
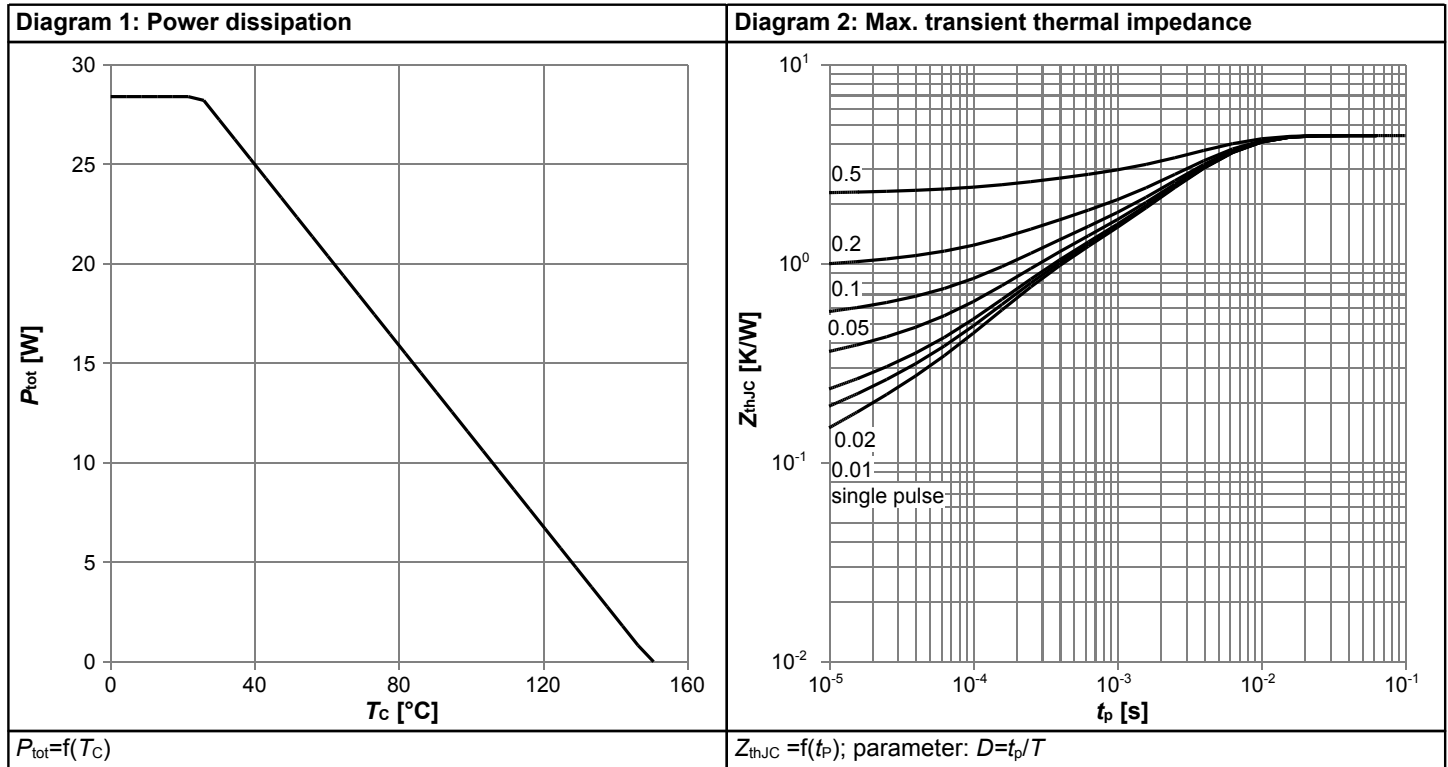
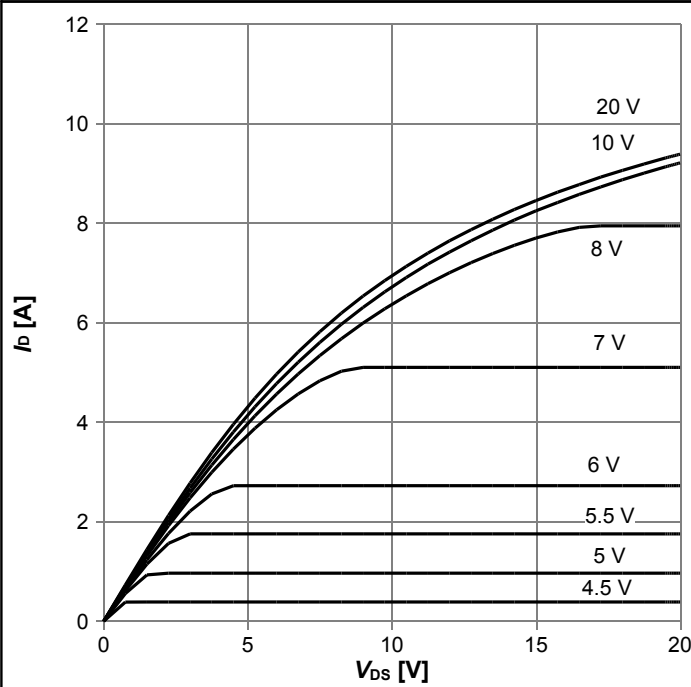

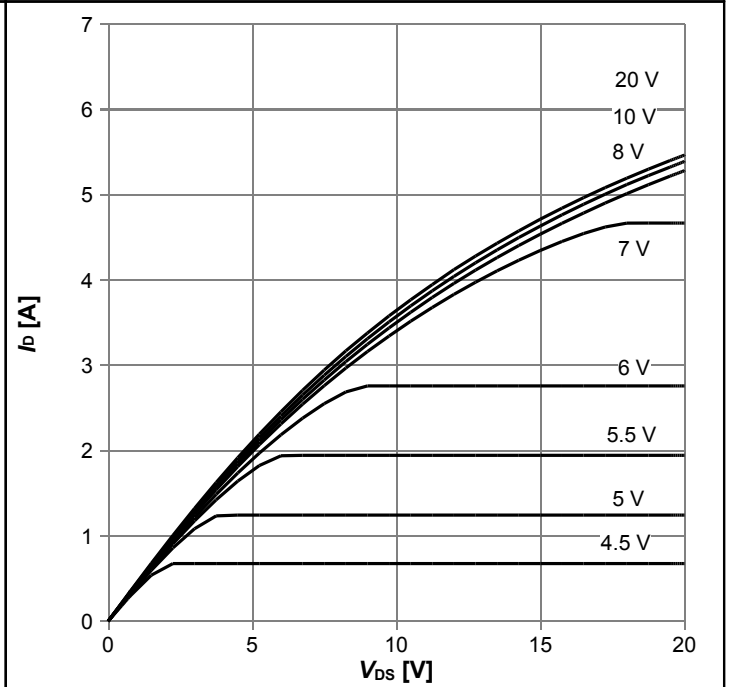

Diagram 5: Typ. output characteristics



$I_D=f(V_{DS}); T_j=25\text{ }^\circ\text{C};$  parameter:  $V_{GS}$

Diagram 6: Typ. output characteristics



$I_D=f(V_{DS}); T_j=125\text{ }^\circ\text{C};$  parameter:  $V_{GS}$

Diagram 7: Typ. drain-source on-state resistance

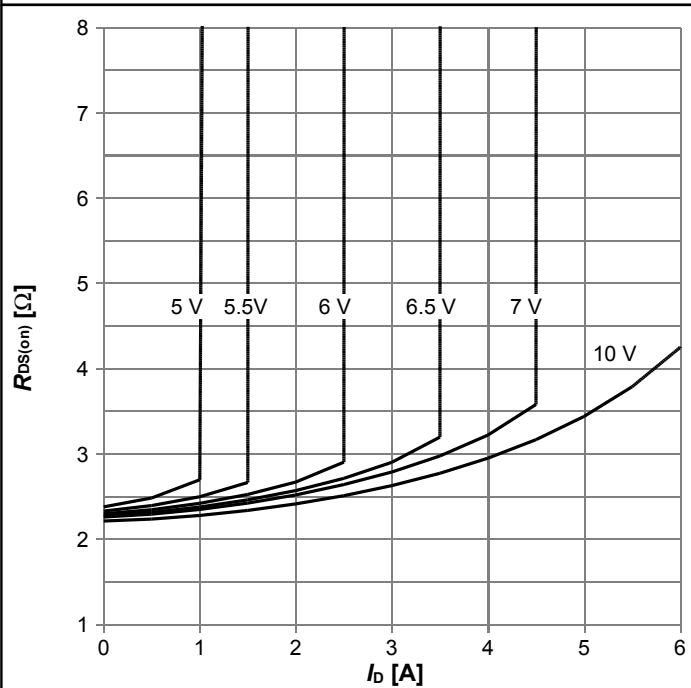

$R_{DS(on)}=f(I_D); T_j=125\text{ }^\circ\text{C};$  parameter:  $V_{GS}$

Diagram 8: Drain-source on-state resistance

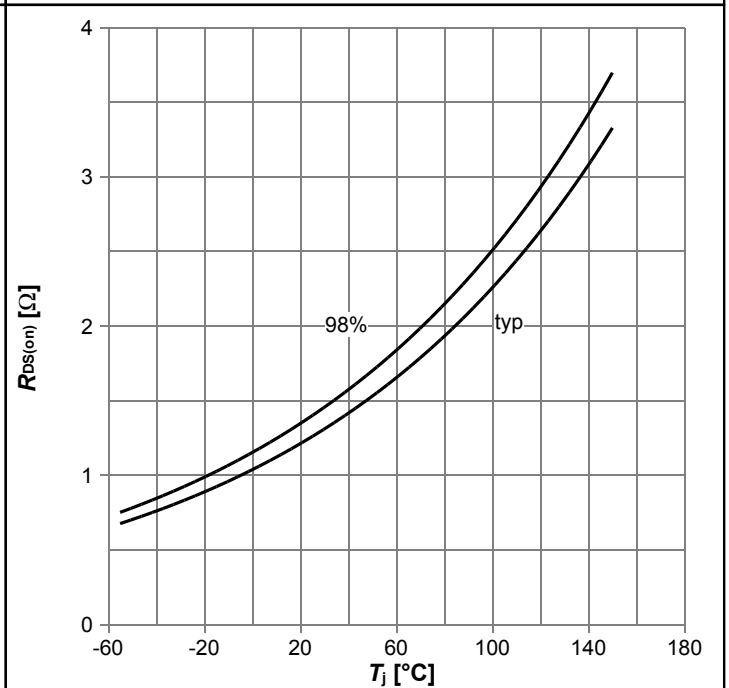

$R_{DS(on)}=f(T_j); I_D=1.0\text{ A}; V_{GS}=10\text{ V}$

Diagram 9: Typ. transfer characteristics

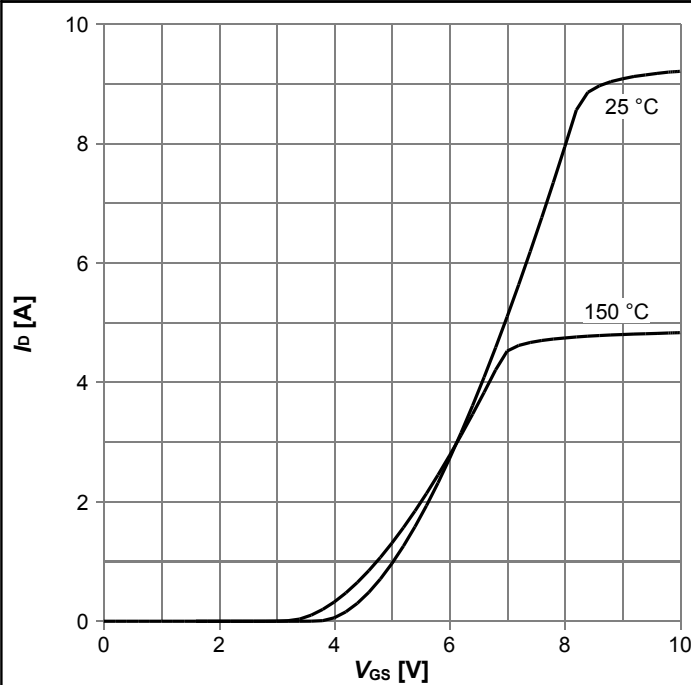

$I_D=f(V_{GS})$ ;  $V_{DS} = 20V$ ; parameter:  $T_j$

Diagram 10: Typ. gate charge

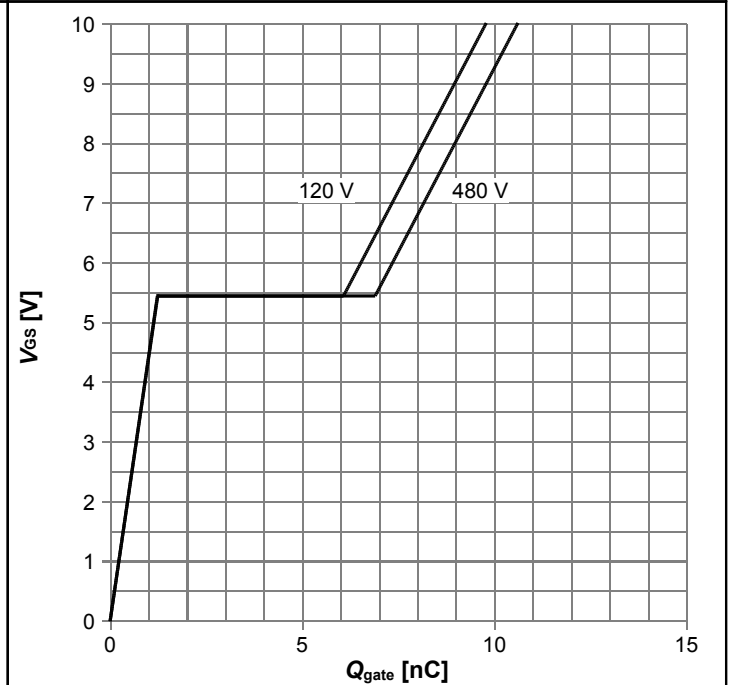

$V_{GS}=f(Q_{gate})$ ;  $I_D=1.5$  A pulsed; parameter:  $V_{DD}$

Diagram 11: Avalanche energy

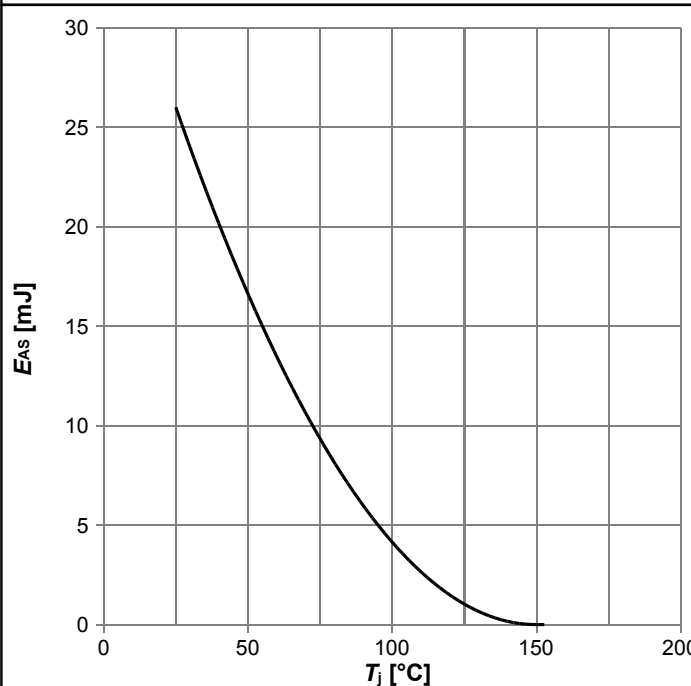

$E_{AS}=f(T_j)$ ;  $I_D=0.6$  A;  $V_{DD}=50$  V

Diagram 12: Drain-source breakdown voltage

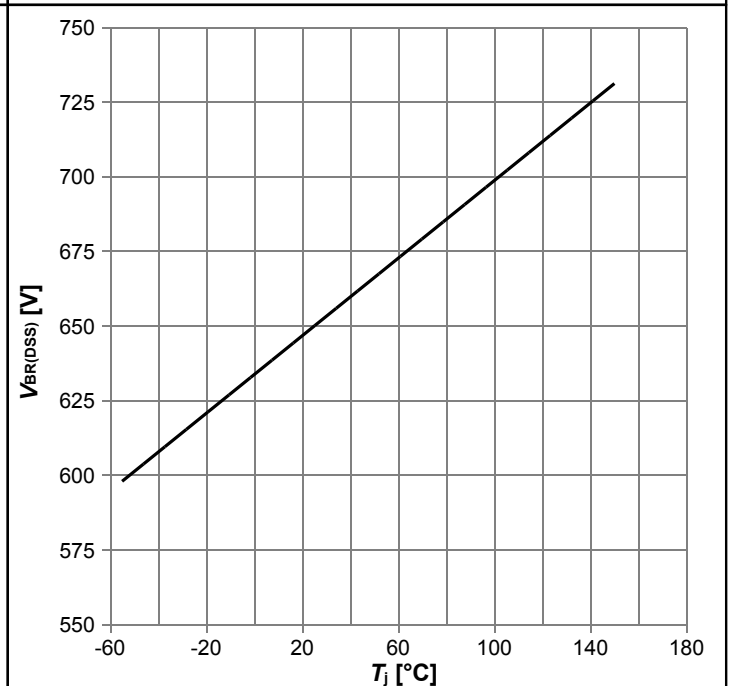

$V_{BR(DSS)}=f(T_j)$ ;  $I_D=1.0$  mA

Diagram 13: Typ. capacitances

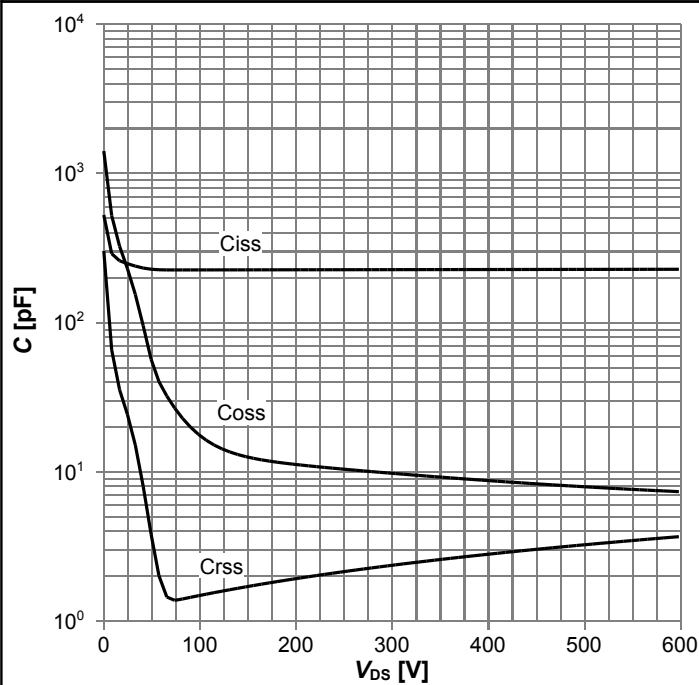

$C=f(V_{DS}); V_{GS}=0\text{ V}; f=1\text{ MHz}$

Diagram 14: Typ. Coss stored energy

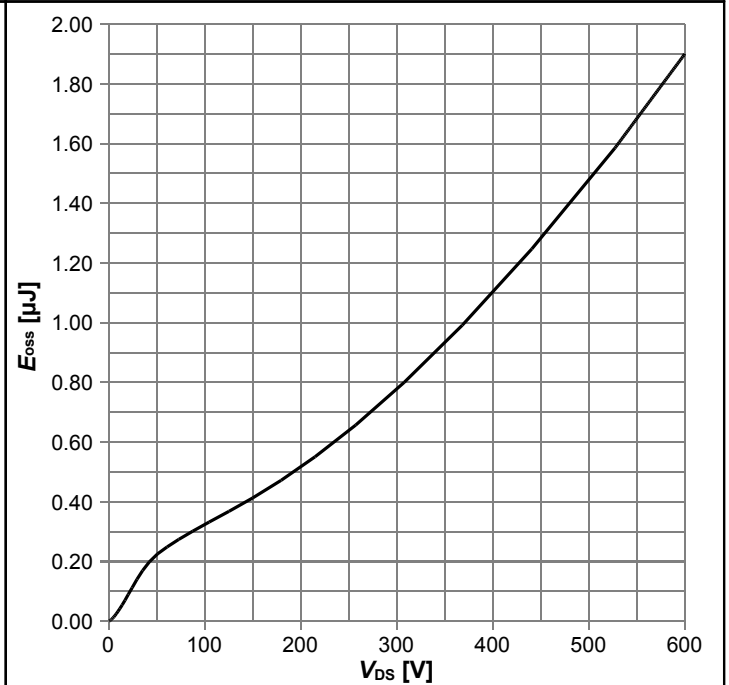

$E_{oss}=f(V_{DS})$

Diagram 15: Forward characteristics of reverse diode

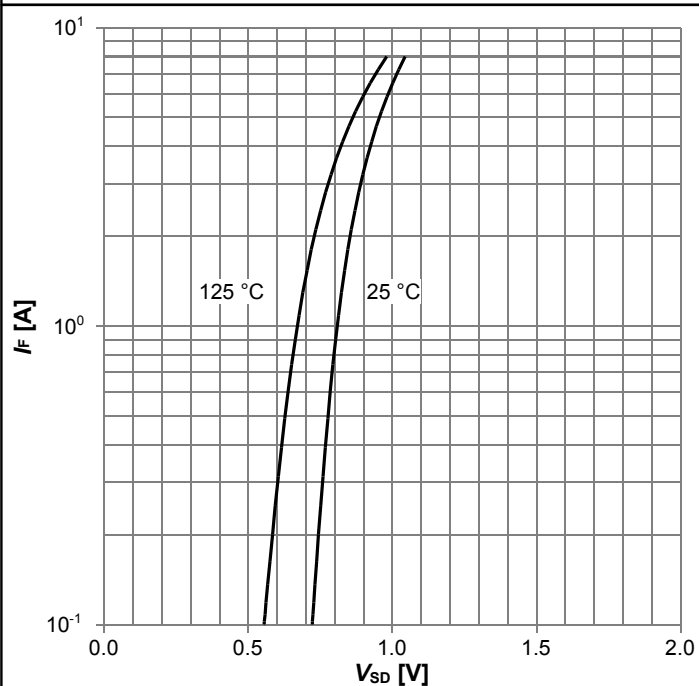

$I_F=f(V_{SD}); \text{parameter: } T_j$

## 6 Test Circuits

**Table 8 Diode characteristics**

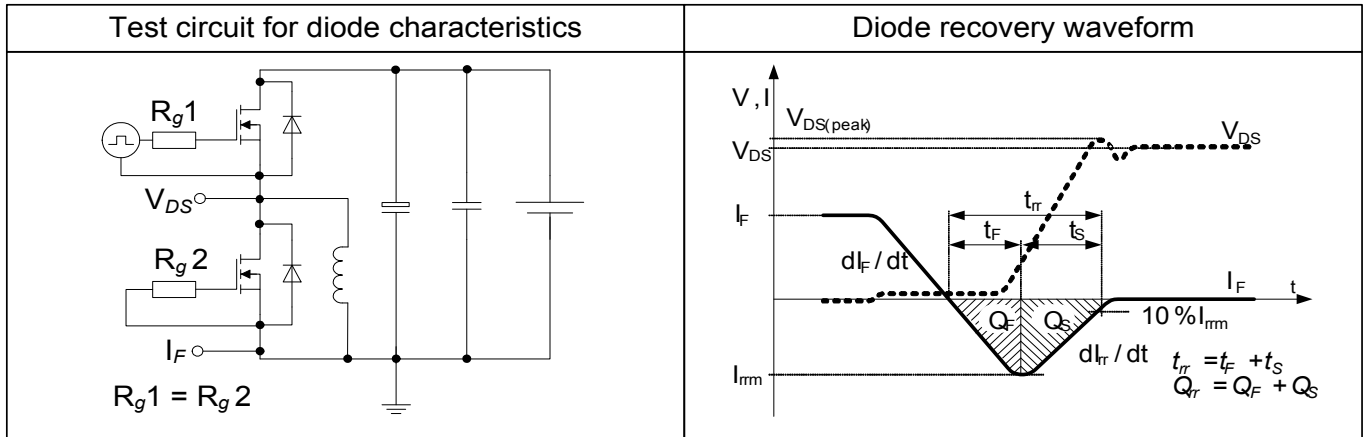

**Table 9 Switching times**

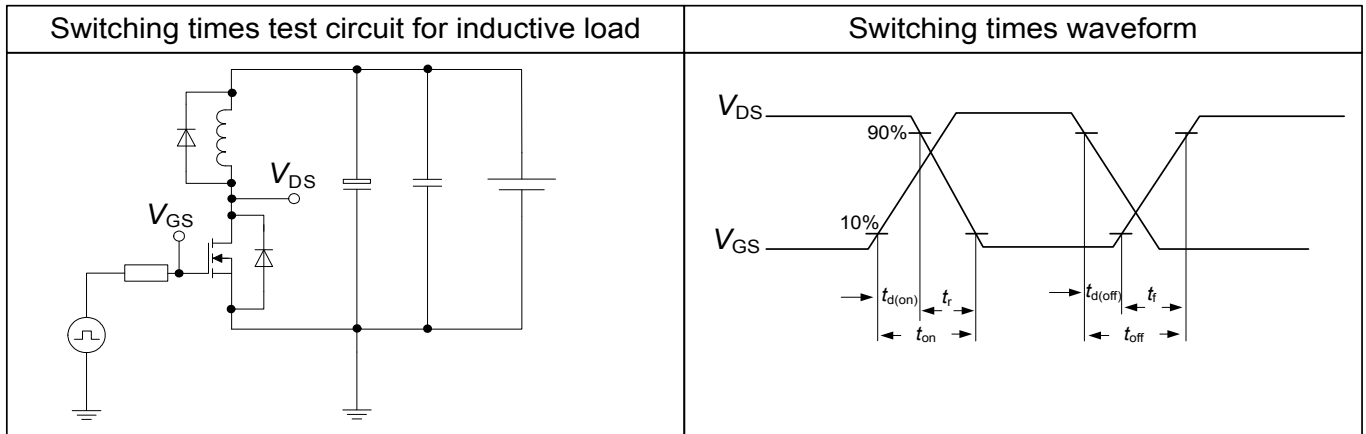

**Table 10 Unclamped inductive load**

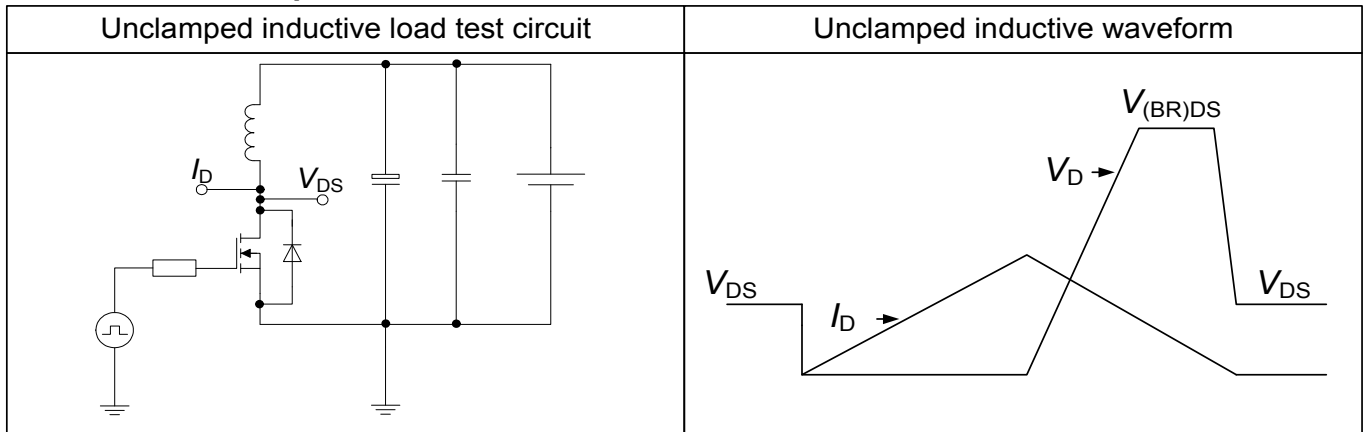

## 7 Package Outlines

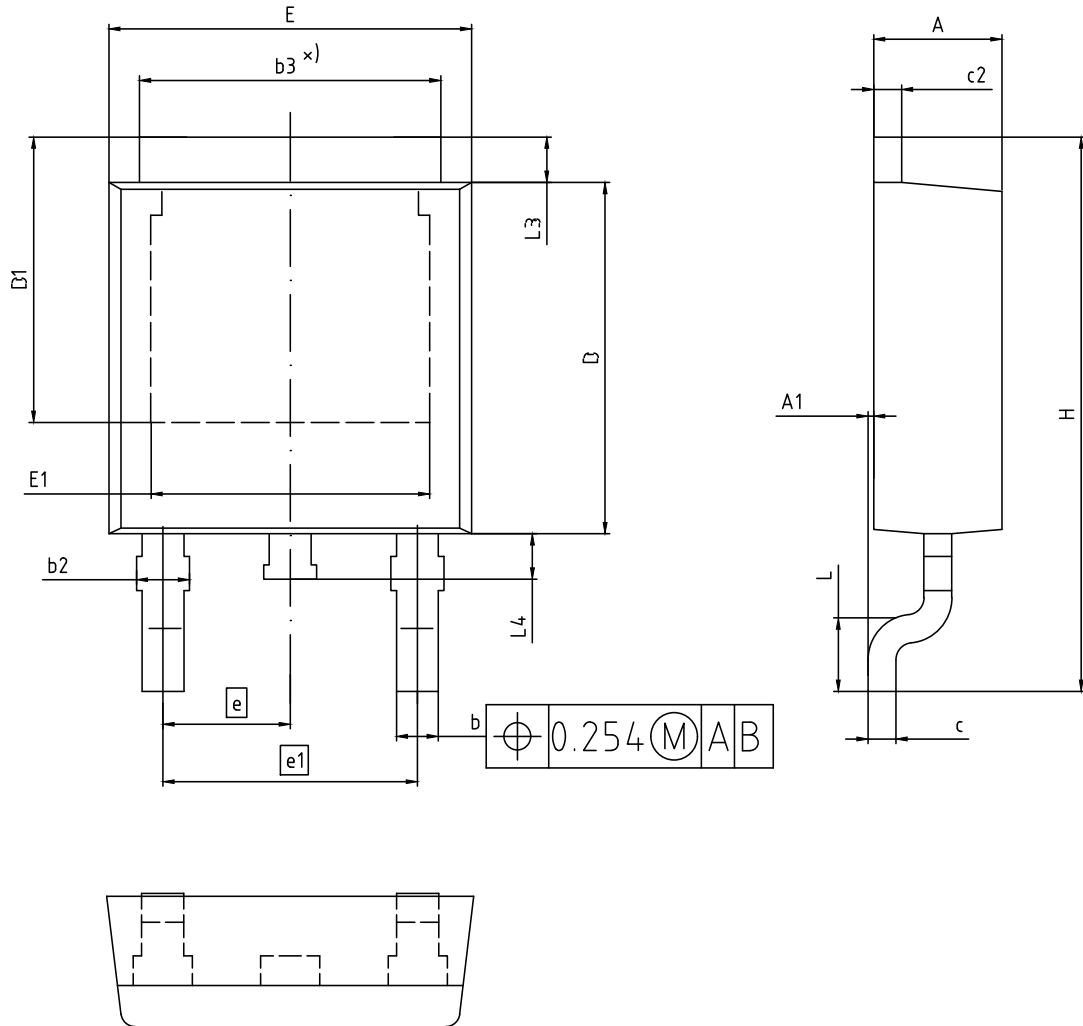

ALL DIMENSIONS REFER TO JEDEC STANDARD TO-252 AND DO NOT INCLUDE MOLD FLASH OR PROTRUSIONS.

DIMENSION	MILLIMETERS	
	MIN.	MAX.
A	2.16	2.41
A1	0.00	0.15
b	0.64	0.89
b2	0.65	1.15
b3	4.95	5.50
c	0.46	0.61
c2	0.40	0.98
D	5.97	6.22
D1	5.02	5.84
E	6.35	6.73
E1	4.32	5.50
e	2.29	
e1	4.57	
N	3	
H	9.40	10.48
L	1.18	1.78
L3	0.89	1.27
L4	0.51	1.02

DOCUMENT NO. Z8B0003328
REVISION 07
SCALE: 10:1 0 1 2mm 
EUROPEAN PROJECTION 
ISSUE DATE 01.04.2020

Figure 1 Outline PG-TO 252, dimensions in mm

## 8 Appendix A

### Table 11 Related Links

- **IFX C6 Product Brief:** [www.infineon.com](http://www.infineon.com)
- **IFX C6 Portfolio:** [www.infineon.com](http://www.infineon.com)
- **IFX CoolMOS Webpage:** [www.infineon.com](http://www.infineon.com)
- **IFX Design Tools:** [www.infineon.com](http://www.infineon.com)

## Revision History

IPD65R1K4C6

**Revision: 2020-05-26, Rev. 2.1**

Previous Revision

Revision	Date	Subjects (major changes since last revision)
2.0	2013-07-26	Release of final version
2.1	2020-05-26	Update of the package outlines

### Trademarks

All referenced product or service names and trademarks are the property of their respective owners.

### We Listen to Your Comments

Any information within this document that you feel is wrong, unclear or missing at all? Your feedback will help us to continuously improve the quality of this document. Please send your proposal (including a reference to this document) to:

**erratum@infineon.com**

### Published by

**Infineon Technologies AG**

**81726 München, Germany**

**© 2020 Infineon Technologies AG**

**All Rights Reserved.**

### Legal Disclaimer

The information given in this document shall in no event be regarded as a guarantee of conditions or characteristics ("Beschaffungsgarantie").

With respect to any examples, hints or any typical values stated herein and/or any information regarding the application of the product, Infineon Technologies hereby disclaims any and all warranties and liabilities of any kind, including without limitation warranties of non-infringement of intellectual property rights of any third party.

In addition, any information given in this document is subject to customer's compliance with its obligations stated in this document and any applicable legal requirements, norms and standards concerning customer's products and any use of the product of Infineon Technologies in customer's applications.

The data contained in this document is exclusively intended for technically trained staff. It is the responsibility of customer's technical departments to evaluate the suitability of the product for the intended application and the completeness of the product information given in this document with respect to such application.

### Information

For further information on technology, delivery terms and conditions and prices please contact your nearest Infineon Technologies Office ([www.infineon.com](http://www.infineon.com)).

### Warnings

Due to technical requirements, components may contain dangerous substances. For information on the types in question, please contact the nearest Infineon Technologies Office.

The Infineon Technologies component described in this Data Sheet may be used in life-support devices or systems and/or automotive, aviation and aerospace applications or systems only with the express written approval of Infineon Technologies, if a failure of such components can reasonably be expected to cause the failure of that life-support, automotive, aviation and aerospace device or system or to affect the safety or effectiveness of that device or system. Life support devices or systems are intended to be implanted in the human body or to support and/or maintain and sustain and/or protect human life. If they fail, it is reasonable to assume that the health of the user or other persons may be endangered.