

- Generation V Technology
- Ultra Low On-Resistance
- Dual N-Channel MOSFET
- Very Small SOIC Package
- Low Profile (<1.1mm)
- Available in Tape & Reel
- Fast Switching

## Description

Fifth Generation HEXFETs from International Rectifier utilize advanced processing techniques to achieve extremely low on-resistance per silicon area. This benefit, combined with the fast switching speed and ruggedized device design that HEXFET Power MOSFETs are well known for, provides the designer with an extremely efficient and reliable device for use in a wide variety of applications.

The new Micro8 package, with half the footprint area of the standard SO-8, provides the smallest footprint available in an SOIC outline. This makes the Micro8 an ideal device for applications where printed circuit board space is at a premium. The low profile (<1.1mm) of the Micro8 will allow it to fit easily into extremely thin application environments such as portable electronics and PCMCIA cards.

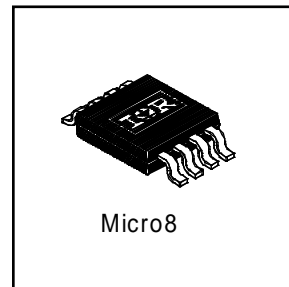
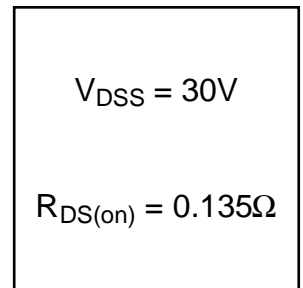
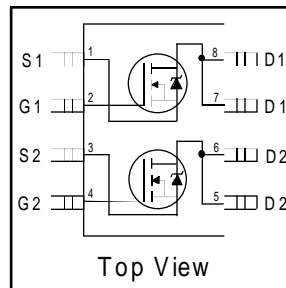

## Absolute Maximum Ratings

	Parameter	Max.	Units
$I_D$ @ $T_A = 25^\circ C$	Continuous Drain Current, $V_{GS}$ @ 10V	2.4	A
$I_D$ @ $T_A = 70^\circ C$	Continuous Drain Current, $V_{GS}$ @ 10V	1.9	
$I_{DM}$	Pulsed Drain Current ①	14	
$P_D$ @ $T_A = 25^\circ C$	Power Dissipation	1.25	W
	Linear Derating Factor	10	mW/°C
$V_{GS}$	Gate-to-Source Voltage	± 20	V
dv/dt	Peak Diode Recovery dv/dt ②	5.0	V/ns
$T_J, T_{STG}$	Junction and Storage Temperature Range	-55 to + 150	°C

## Thermal Resistance

	Parameter	Typ.	Max.	Units
$R_{\theta JA}$	Maximum Junction-to-Ambient ④	—	100	°C/W

All Micro8 Data Sheets reflect improved Thermal Resistance, Power and Current -Handling Ratings- effective only for product marked with Date Code 505 or later .

## Electrical Characteristics @ $T_J = 25^\circ\text{C}$ (unless otherwise specified)

	Parameter	Min.	Typ.	Max.	Units	Conditions
$V_{(BR)DSS}$	Drain-to-Source Breakdown Voltage	30	—	—	V	$V_{GS} = 0V, I_D = 250\mu A$
$\Delta V_{(BR)DSS}/\Delta T_J$	Breakdown Voltage Temp. Coefficient	—	0.059	—	V/ $^\circ\text{C}$	Reference to $25^\circ\text{C}, I_D = 1mA$
$R_{DS(on)}$	Static Drain-to-Source On-Resistance	—	—	0.135	$\Omega$	$V_{GS} = 10V, I_D = 1.7A$ ③
		—	—	0.222		$V_{GS} = 4.5V, I_D = 0.85A$ ③
$V_{GS(th)}$	Gate Threshold Voltage	1.0	—	—	V	$V_{DS} = V_{GS}, I_D = 250\mu A$
$g_{fs}$	Forward Transconductance	1.9	—	—	S	$V_{DS} = 10V, I_D = 0.85A$
$I_{DSS}$	Drain-to-Source Leakage Current	—	—	1.0	$\mu A$	$V_{DS} = 24V, V_{GS} = 0V$
		—	—	25		$V_{DS} = 24V, V_{GS} = 0V, T_J = 125^\circ\text{C}$
$I_{GSS}$	Gate-to-Source Forward Leakage	—	—	-100	nA	$V_{GS} = -20V$
	Gate-to-Source Reverse Leakage	—	—	100		$V_{GS} = 20V$
$Q_g$	Total Gate Charge	—	7.8	12	nC	$I_D = 1.7A$
$Q_{gs}$	Gate-to-Source Charge	—	1.2	1.8		$V_{DS} = 24V$
$Q_{gd}$	Gate-to-Drain ("Miller") Charge	—	2.5	3.8		$V_{GS} = 10V$ , See Fig. 6 and 9 ③
$t_{d(on)}$	Turn-On Delay Time	—	4.7	—	ns	$V_{DD} = 15V$
$t_r$	Rise Time	—	10	—		$I_D = 1.7A$
$t_{d(off)}$	Turn-Off Delay Time	—	12	—		$R_G = 6.1\Omega$
$t_f$	Fall Time	—	5.3	—		$R_D = 8.7\Omega$ , See Fig. 10 ③
$C_{iss}$	Input Capacitance	—	210	—	pF	$V_{GS} = 0V$
$C_{oss}$	Output Capacitance	—	80	—		$V_{DS} = 25V$
$C_{riss}$	Reverse Transfer Capacitance	—	32	—		$f = 1.0MHz$ , See Fig. 5

## Source-Drain Ratings and Characteristics

	Parameter	Min.	Typ.	Max.	Units	Conditions
$I_S$	Continuous Source Current (Body Diode)	—	—	1.25	A	MOSFET symbol showing the integral reverse p-n junction diode.
$I_{SM}$	Pulsed Source Current (Body Diode) ①	—	—	14		
$V_{SD}$	Diode Forward Voltage	—	—	1.2	V	$T_J = 25^\circ\text{C}, I_S = 1.7A, V_{GS} = 0V$ ③
$t_{rr}$	Reverse Recovery Time	—	40	60	ns	$T_J = 25^\circ\text{C}, I_F = 1.7A$
$Q_{rr}$	Reverse Recovery Charge	—	48	72	nC	$di/dt = 100A/\mu s$ ③

### Notes:

- ① Repetitive rating; pulse width limited by max. junction temperature. ( See fig. 11 )
- ②  $I_{SD} \leq 1.7A, di/dt \leq 120A/\mu s, V_{DD} \leq V_{(BR)DSS}, T_J \leq 150^\circ\text{C}$
- ③ Pulse width  $\leq 300\mu s$ ; duty cycle  $\leq 2\%$ .
- ④ Surface mounted on FR-4 board,  $t \leq 10sec$ .

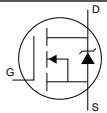

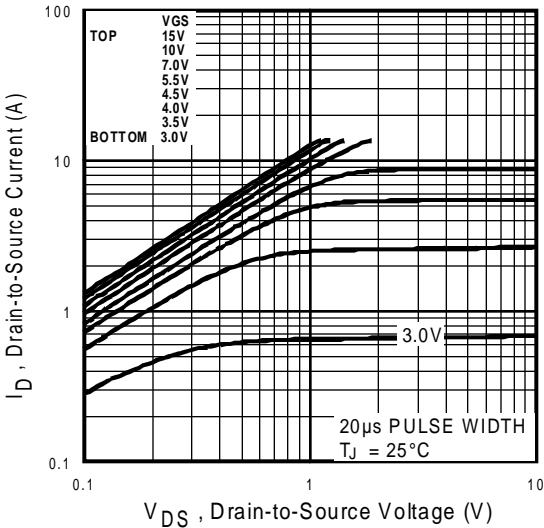

Fig 1. Typical Output Characteristics

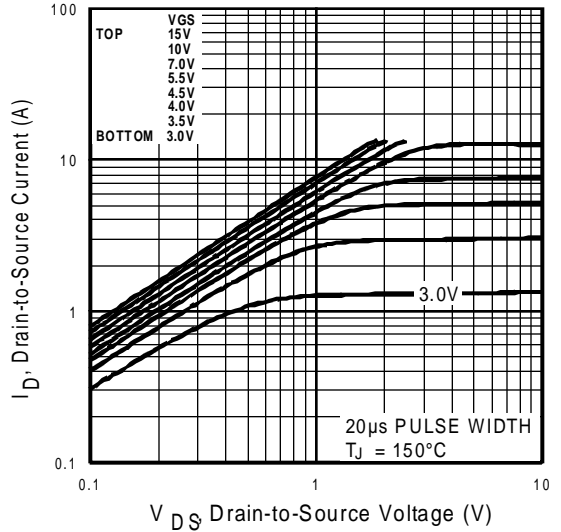

Fig 2. Typical Output Characteristics

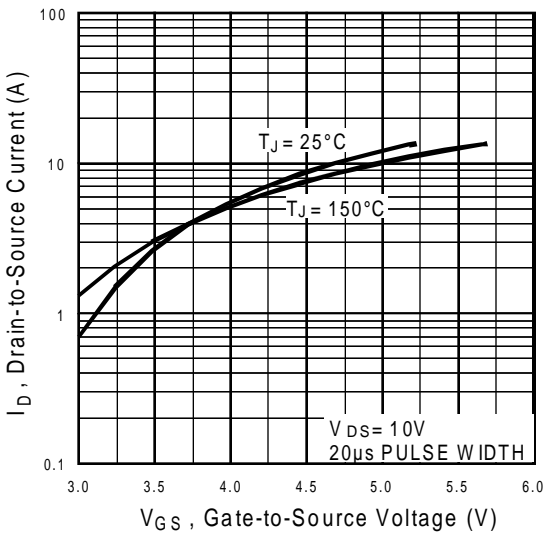

Fig 3. Typical Transfer Characteristics

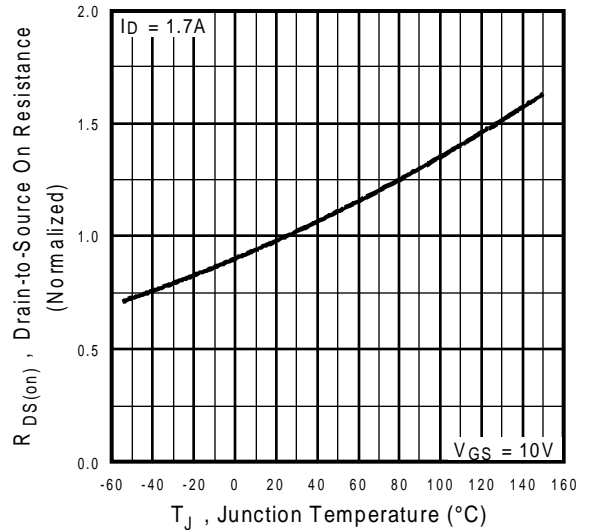
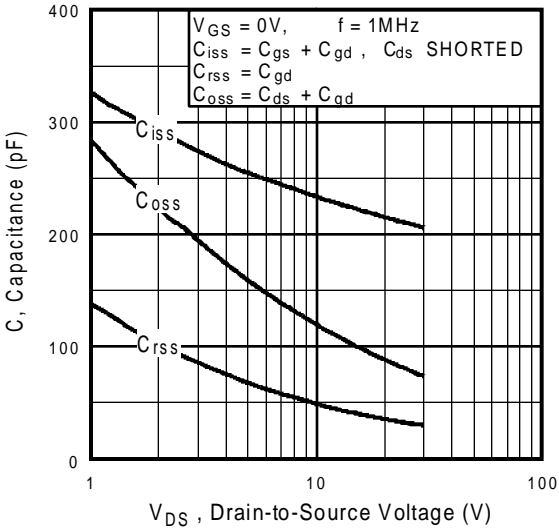
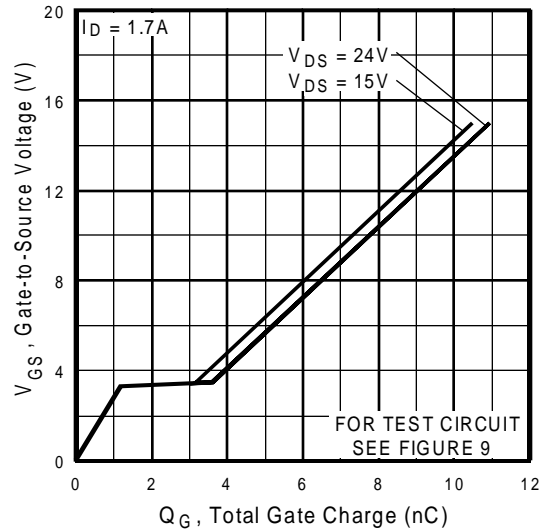

Fig 4. Normalized On-Resistance Vs. Temperature



**Fig 5.** Typical Capacitance Vs. Drain-to-Source Voltage



**Fig 6.** Typical Gate Charge Vs. Gate-to-Source Voltage

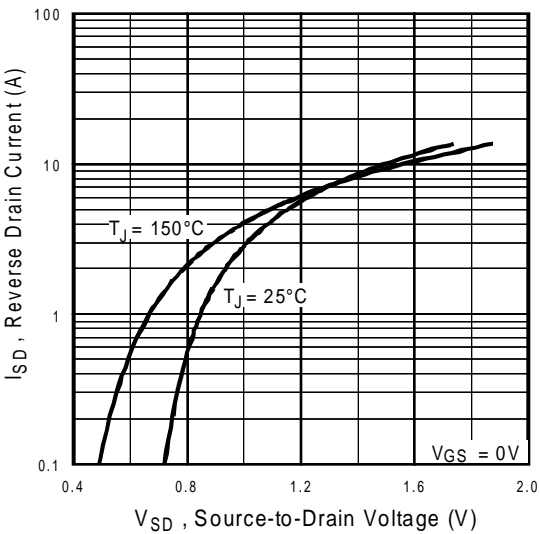

**Fig 7.** Typical Source-Drain Diode Forward Voltage

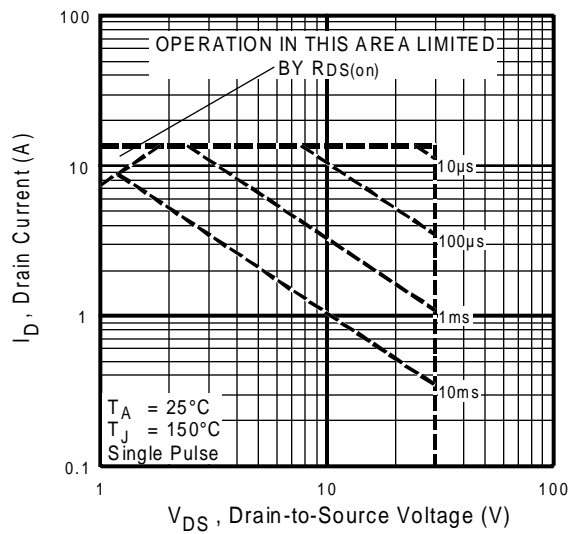

**Fig 8.** Maximum Safe Operating Area

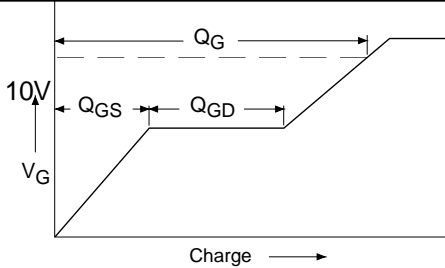

Fig 9a. Basic Gate Charge Waveform

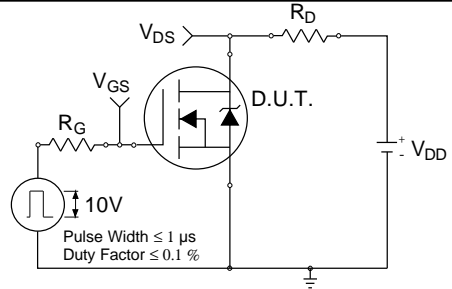

Fig 10a. Switching Time Test Circuit

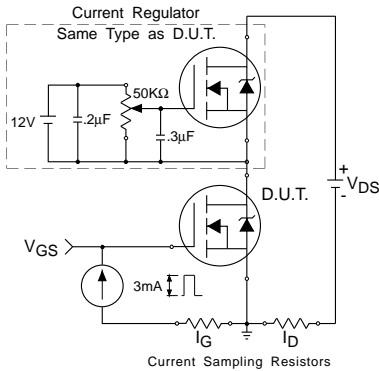

Fig 9b. Gate Charge Test Circuit

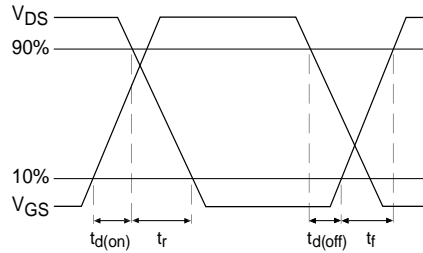

Fig 10b. Switching Time Waveforms

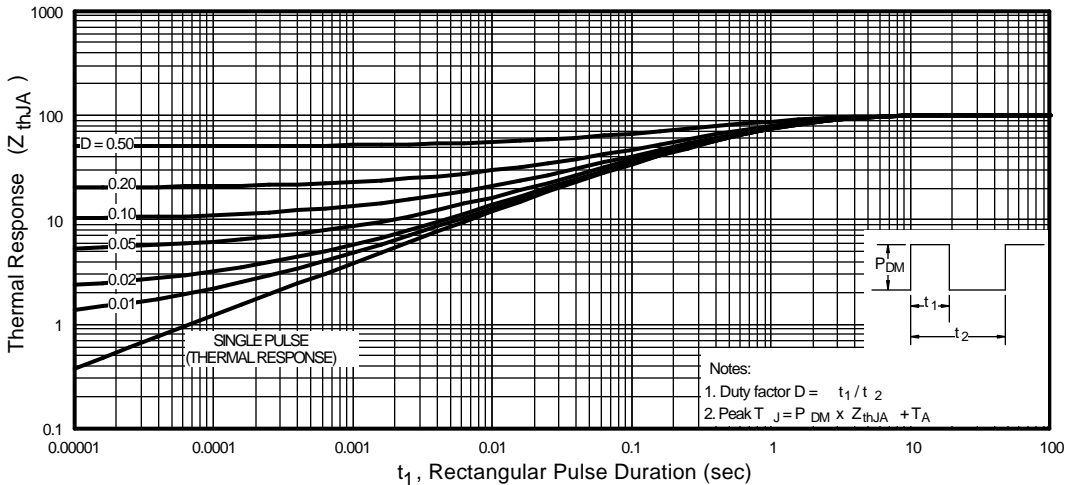
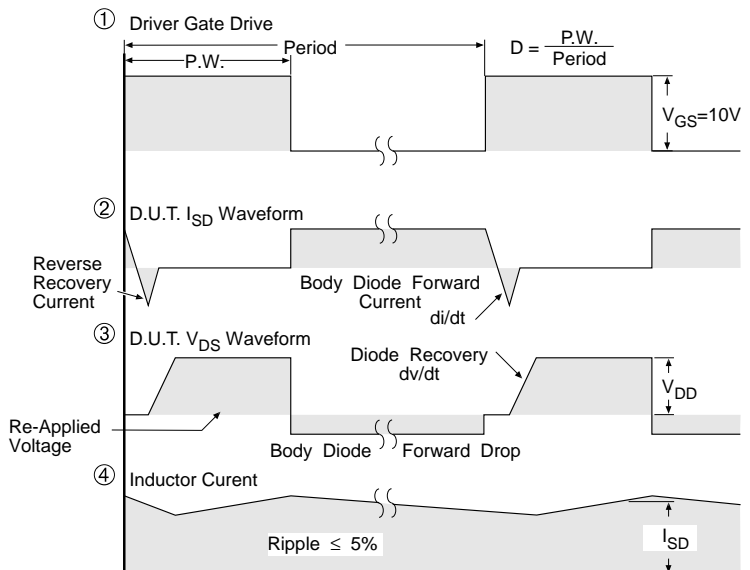
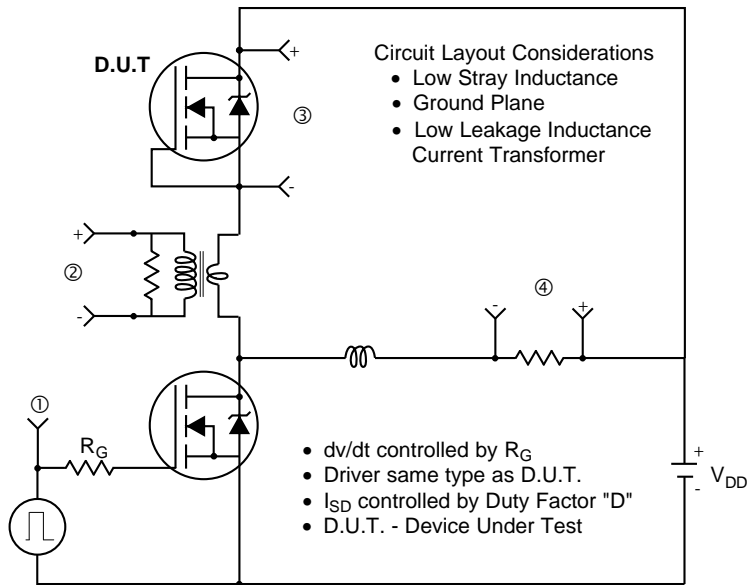

Fig 11. Maximum Effective Transient Thermal Impedance, Junction-to-Ambient

## Peak Diode Recovery $dv/dt$ Test Circuit



\*  $V_{GS} = 5V$  for Logic Level Devices

**Fig 12.** For N-Channel HEXFETS

## Package Outline

### Micro8 Outline

Dimensions are shown in millimeters (inches)

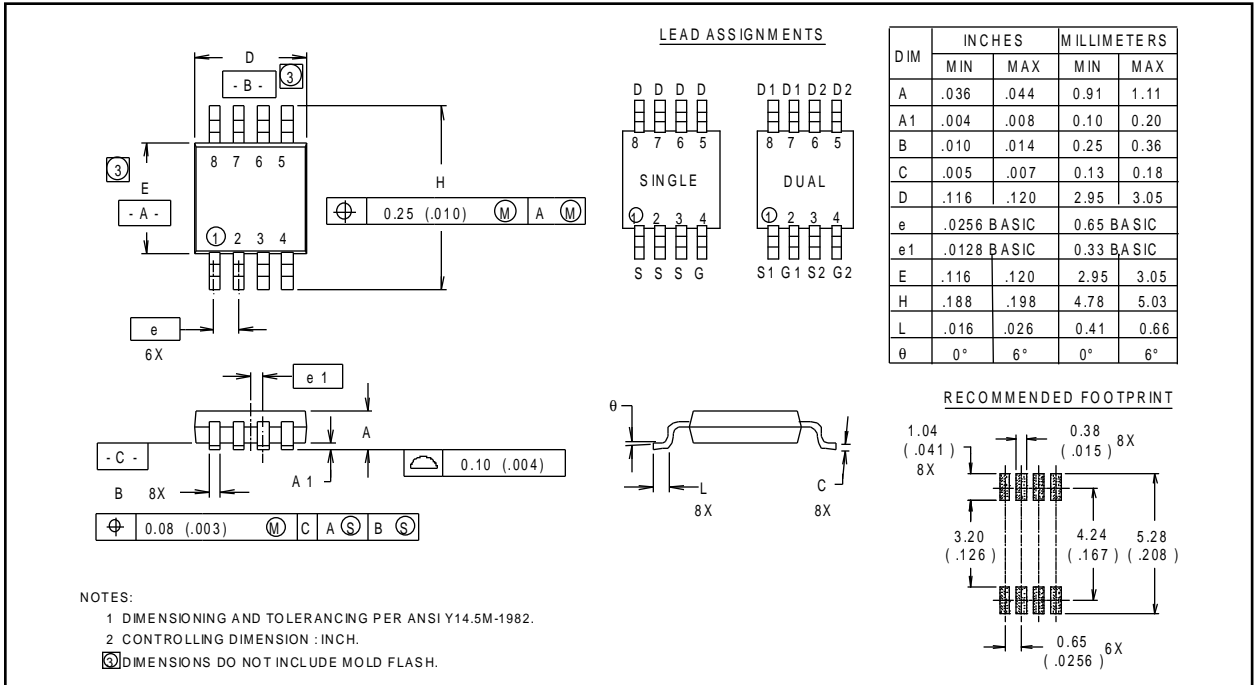

## Part Marking Information

### Micro8

EXAMPLE : THIS IS AN IRF7501

