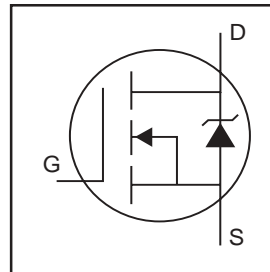


**Features**

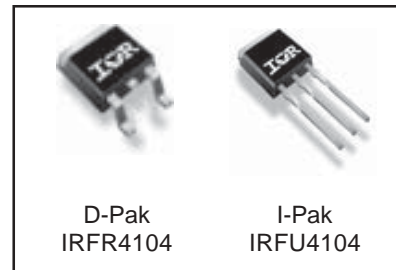
- Advanced Process Technology
- Ultra Low On-Resistance
- 175°C Operating Temperature
- Fast Switching
- Repetitive Avalanche Allowed up to Tjmax



$V_{DSS} = 40V$
$R_{DS(on)} = 5.5m\Omega$
$I_D = 42A$

**Description**

Specifically designed for Automotive applications, this HEXFET® Power MOSFET utilizes the latest processing techniques to achieve extremely low on-resistance per silicon area. Additional features of this design are a 175°C junction operating temperature, fast switching speed and improved repetitive avalanche rating. These features combine to make this design an extremely efficient and reliable device for use in Automotive applications and a wide variety of other applications.



**Absolute Maximum Ratings**

	Parameter	Max.	Units
$I_D @ T_C = 25^\circ C$	Continuous Drain Current, $V_{GS} @ 10V$ (Silicon Limited)	119	A
$I_D @ T_C = 100^\circ C$	Continuous Drain Current, $V_{GS} @ 10V$	84	
$I_D @ T_C = 25^\circ C$	Continuous Drain Current, $V_{GS} @ 10V$ (Package Limited)	42	
$I_{DM}$	Pulsed Drain Current ①	480	
$P_D @ T_C = 25^\circ C$	Power Dissipation	140	W
	Linear Derating Factor	0.95	W/°C
$V_{GS}$	Gate-to-Source Voltage	$\pm 20$	V
$E_{AS}$ (Thermally limited)	Single Pulse Avalanche Energy ②	145	mJ
$E_{AS}$ (Tested )	Single Pulse Avalanche Energy Tested Value ③	310	
$I_{AR}$	Avalanche Current ④	See Fig.12a, 12b, 15, 16	A
$E_{AR}$	Repetitive Avalanche Energy ⑤		mJ
$T_J$	Operating Junction and	-55 to + 175	°C
$T_{STG}$	Storage Temperature Range		
	Soldering Temperature, for 10 seconds	300 (1.6mm from case )	
	Mounting Torque, 6-32 or M3 screw	10 lbf•in (1.1N•m)	

**Thermal Resistance**

	Parameter	Typ.	Max.	Units
$R_{\theta JC}$	Junction-to-Case	—	1.05	°C/W
$R_{\theta JA}$	Junction-to-Ambient (PCB mount) ⑥	—	40	
$R_{\theta JA}$	Junction-to-Ambient	—	110	

HEXFET® is a registered trademark of International Rectifier.

www.irf.com

### Electrical Characteristics @ $T_J = 25^\circ\text{C}$ (unless otherwise specified)

	Parameter	Min.	Typ.	Max.	Units	Conditions
$V_{(BR)DSS}$	Drain-to-Source Breakdown Voltage	40	—	—	V	$V_{GS} = 0V, I_D = 250\mu A$
$\Delta V_{(BR)DSS}/\Delta T_J$	Breakdown Voltage Temp. Coefficient	—	0.032	—	V/ $^\circ\text{C}$	Reference to $25^\circ\text{C}$ , $I_D = 1\text{mA}$
$R_{DS(on)}$	Static Drain-to-Source On-Resistance	—	4.3	5.5	m $\Omega$	$V_{GS} = 10V, I_D = 42A$ ③
$V_{GS(th)}$	Gate Threshold Voltage	2.0	—	4.0	V	$V_{DS} = V_{GS}, I_D = 250\mu A$
$g_{fs}$	Forward Transconductance	58	—	—	S	$V_{DS} = 10V, I_D = 42A$
$I_{DSS}$	Drain-to-Source Leakage Current	—	—	20	$\mu A$	$V_{DS} = 40V, V_{GS} = 0V$
		—	—	250		$V_{DS} = 40V, V_{GS} = 0V, T_J = 125^\circ\text{C}$
$I_{GSS}$	Gate-to-Source Forward Leakage	—	—	200	nA	$V_{GS} = 20V$
	Gate-to-Source Reverse Leakage	—	—	-200		$V_{GS} = -20V$
$Q_g$	Total Gate Charge	—	59	89	nC	$I_D = 42A$
$Q_{gs}$	Gate-to-Source Charge	—	19	—		$V_{DS} = 32V$
$Q_{gd}$	Gate-to-Drain ("Miller") Charge	—	24	—		$V_{GS} = 10V$ ③
$t_{d(on)}$	Turn-On Delay Time	—	17	—	ns	$V_{DD} = 20V$
$t_r$	Rise Time	—	69	—		$I_D = 42A$
$t_{d(off)}$	Turn-Off Delay Time	—	37	—		$R_G = 6.8\ \Omega$
$t_f$	Fall Time	—	36	—		$V_{GS} = 10V$ ③
$L_D$	Internal Drain Inductance	—	4.5	—	nH	Between lead, 6mm (0.25in.) from package and center of die contact
$L_S$	Internal Source Inductance	—	7.5	—		
$C_{iss}$	Input Capacitance	—	2950	—	pF	$V_{GS} = 0V$
$C_{oss}$	Output Capacitance	—	660	—		$V_{DS} = 25V$
$C_{rss}$	Reverse Transfer Capacitance	—	370	—		$f = 1.0\text{MHz}$
$C_{oss}$	Output Capacitance	—	2130	—		$V_{GS} = 0V, V_{DS} = 1.0V, f = 1.0\text{MHz}$
$C_{oss}$	Output Capacitance	—	590	—		$V_{GS} = 0V, V_{DS} = 32V, f = 1.0\text{MHz}$
$C_{oss\ eff.}$	Effective Output Capacitance	—	850	—		$V_{GS} = 0V, V_{DS} = 0V\ \text{to}\ 32V$ ④

### Source-Drain Ratings and Characteristics

	Parameter	Min.	Typ.	Max.	Units	Conditions
$I_S$	Continuous Source Current (Body Diode)	—	—	42	A	MOSFET symbol showing the integral reverse p-n junction diode.
$I_{SM}$	Pulsed Source Current (Body Diode) ①	—	—	480		
$V_{SD}$	Diode Forward Voltage	—	—	1.3	V	$T_J = 25^\circ\text{C}, I_S = 42A, V_{GS} = 0V$ ③
$t_{rr}$	Reverse Recovery Time	—	28	42	ns	$T_J = 25^\circ\text{C}, I_F = 42A, V_{DD} = 20V$
$Q_{rr}$	Reverse Recovery Charge	—	24	36	nC	$di/dt = 100A/\mu s$ ③
$t_{on}$	Forward Turn-On Time	Intrinsic turn-on time is negligible (turn-on is dominated by $L_S+L_D$ )				

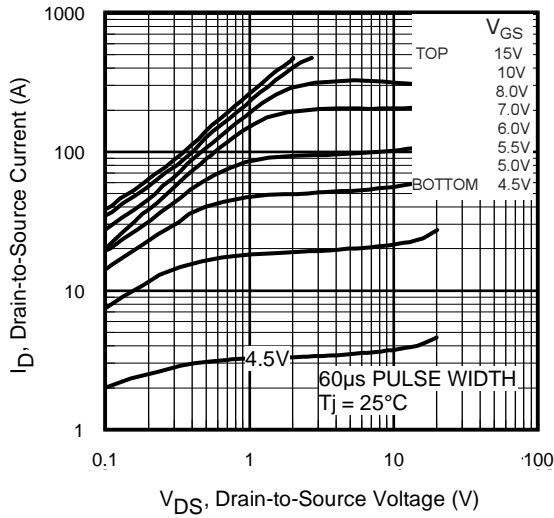


Fig 1. Typical Output Characteristics

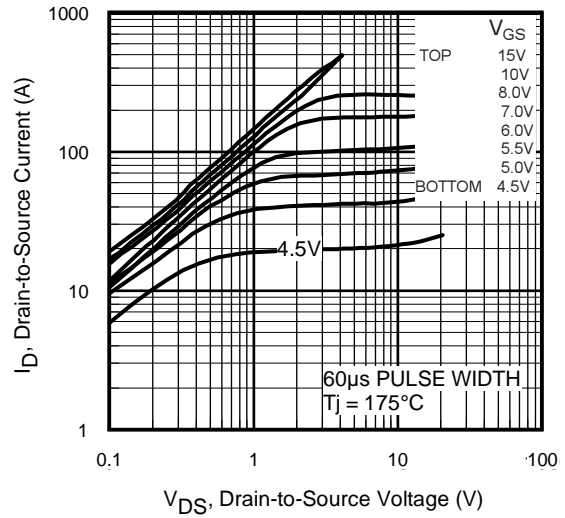


Fig 2. Typical Output Characteristics

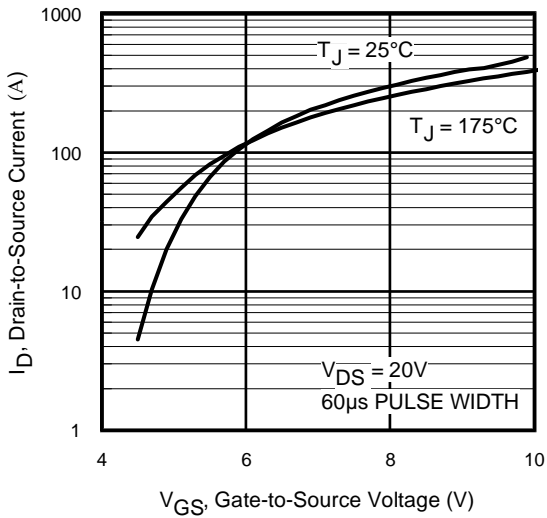


Fig 3. Typical Transfer Characteristics

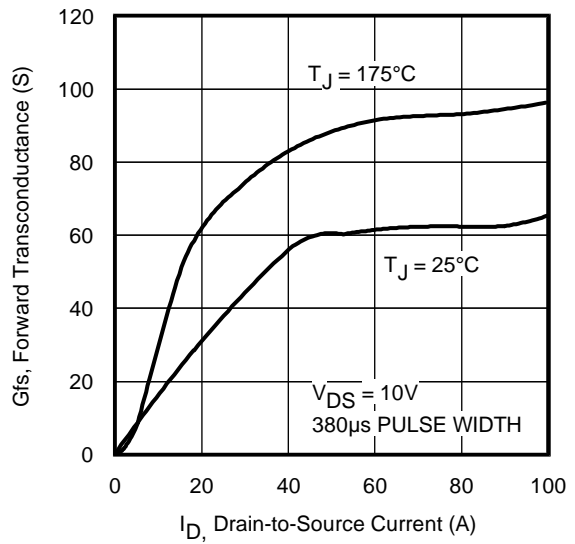
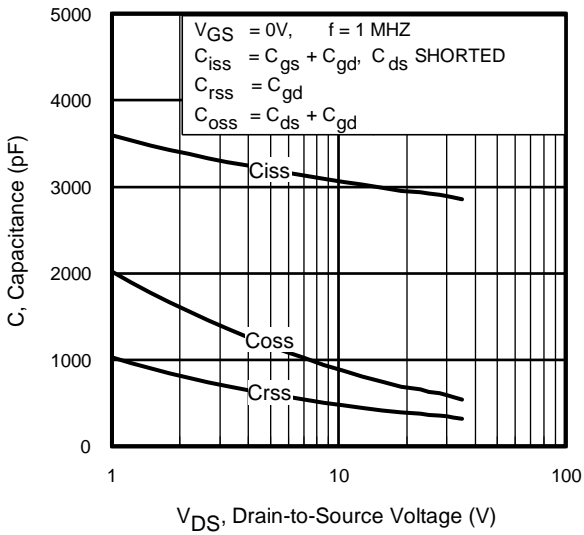
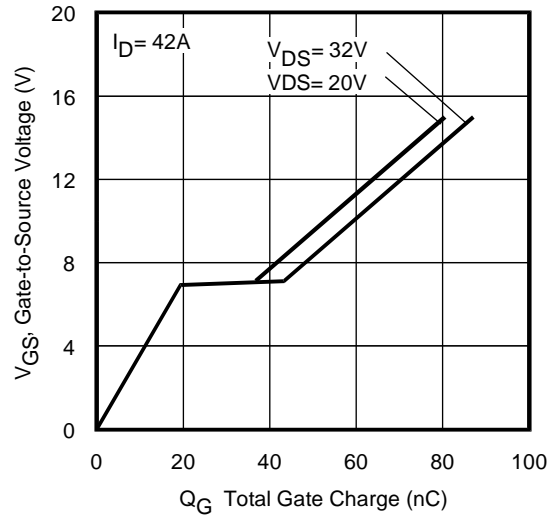


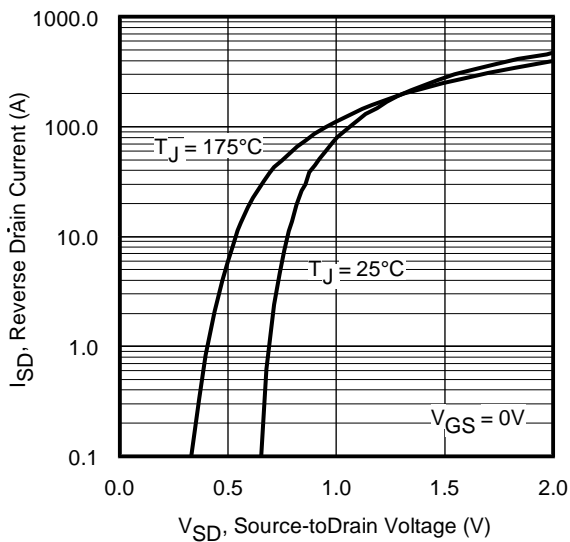
Fig 4. Typical Forward Transconductance Vs. Drain Current



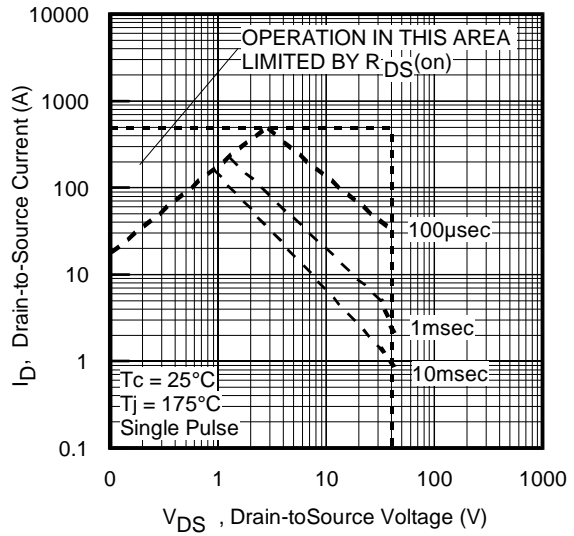
**Fig 5.** Typical Capacitance Vs. Drain-to-Source Voltage



**Fig 6.** Typical Gate Charge Vs. Gate-to-Source Voltage



**Fig 7.** Typical Source-Drain Diode Forward Voltage



**Fig 8.** Maximum Safe Operating Area

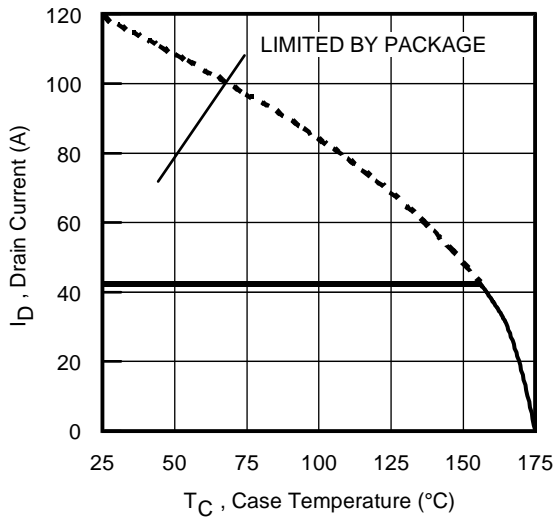


Fig 9. Maximum Drain Current Vs. Case Temperature

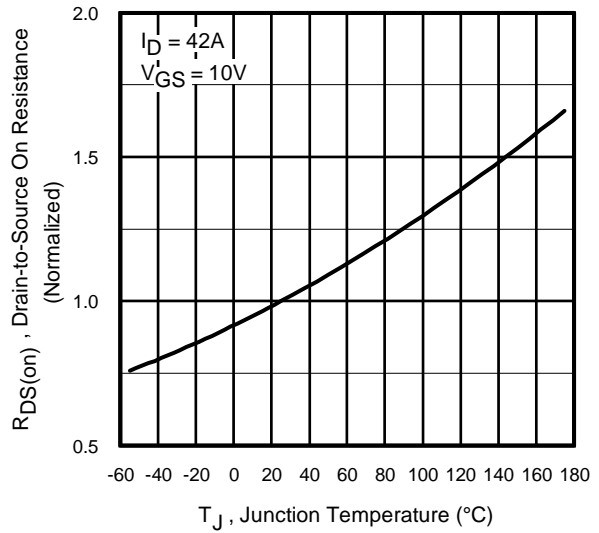


Fig 10. Normalized On-Resistance Vs. Temperature

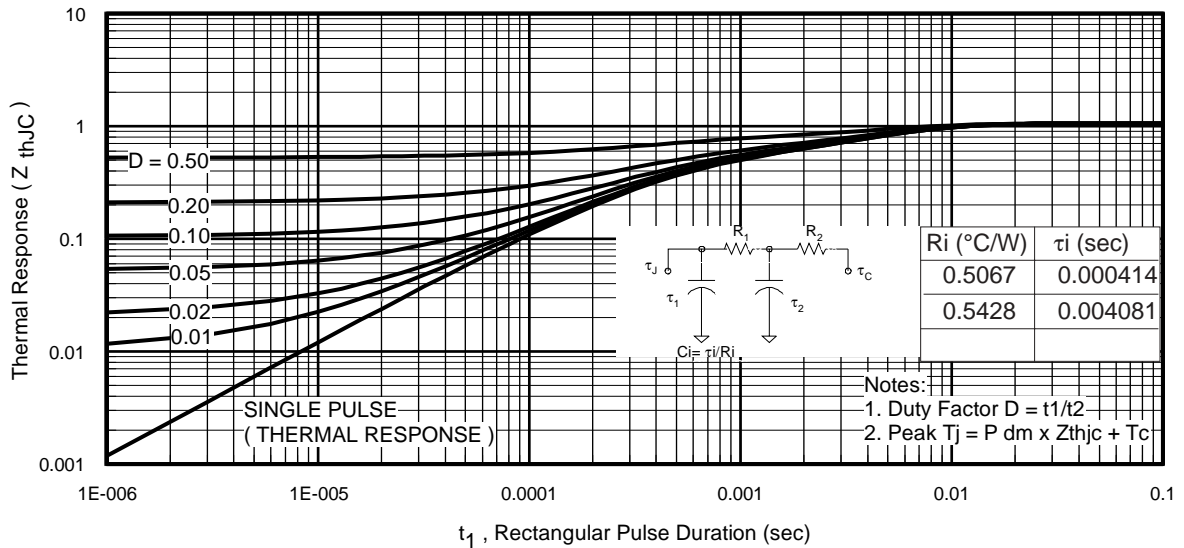
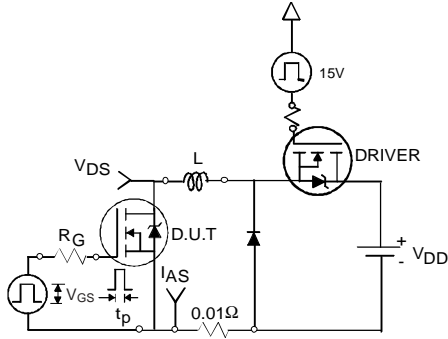
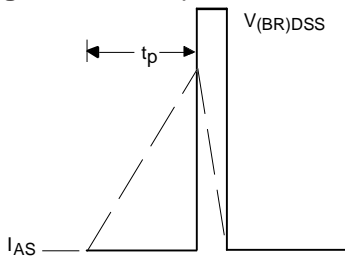


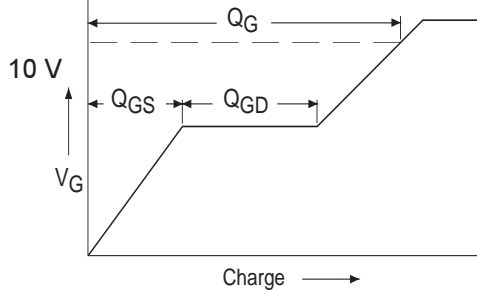
Fig 11. Maximum Effective Transient Thermal Impedance, Junction-to-Case



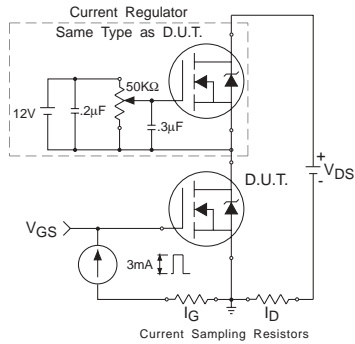
**Fig 12a.** Unclamped Inductive Test Circuit



**Fig 12b.** Unclamped Inductive Waveforms

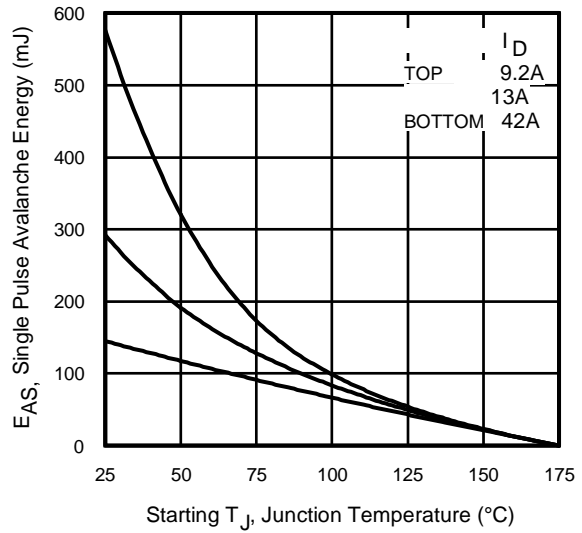


**Fig 13a.** Basic Gate Charge Waveform

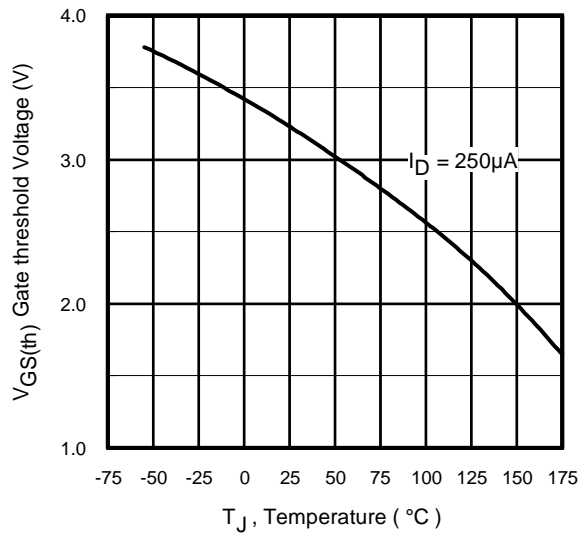


**Fig 13b.** Gate Charge Test Circuit

6



**Fig 12c.** Maximum Avalanche Energy Vs. Drain Current



**Fig 14.** Threshold Voltage Vs. Temperature

www.irf.com

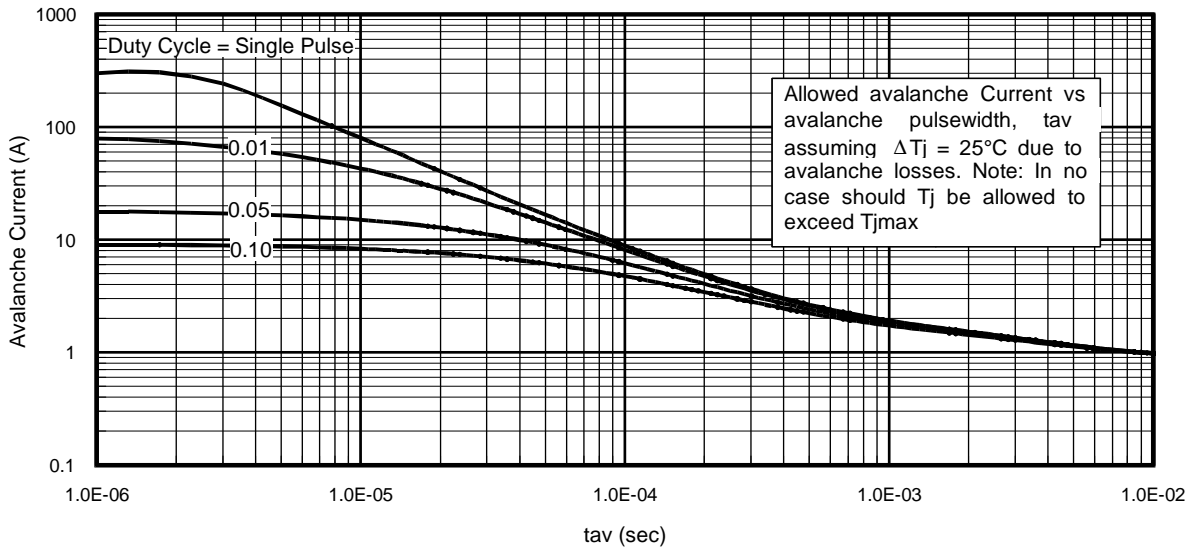


Fig 15. Typical Avalanche Current Vs.Pulsewidth

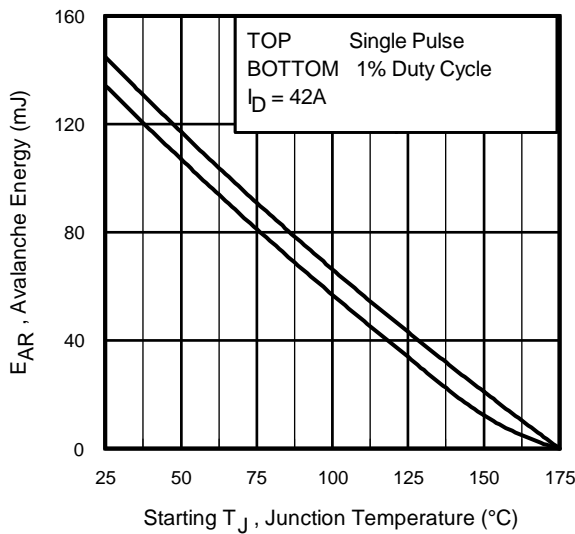


Fig 16. Maximum Avalanche Energy Vs. Temperature

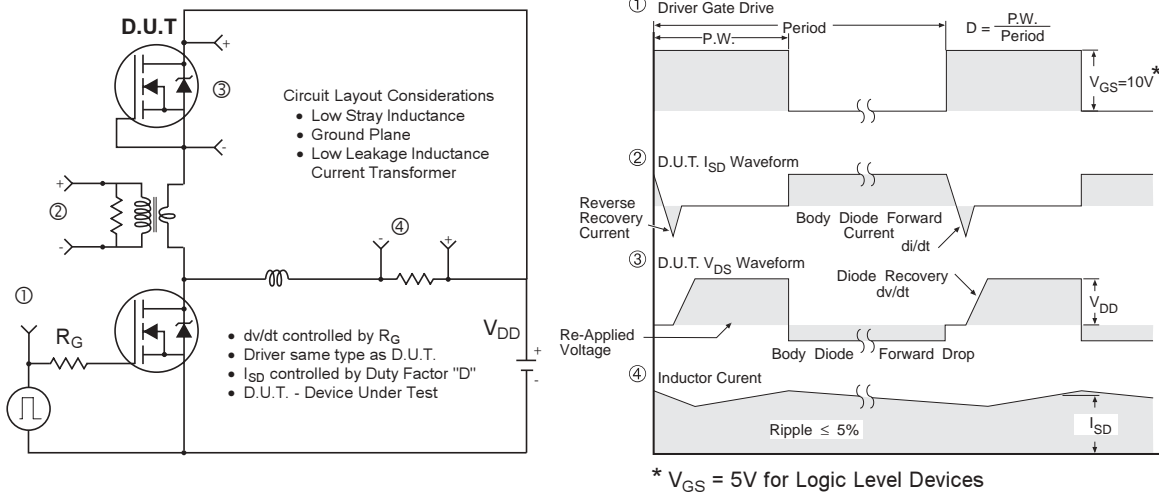
**Notes on Repetitive Avalanche Curves , Figures 15, 16:**  
(For further info, see AN-1005 at [www.irf.com](http://www.irf.com))

1. Avalanche failures assumption:  
Purely a thermal phenomenon and failure occurs at a temperature far in excess of  $T_{jmax}$ . This is validated for every part type.
2. Safe operation in Avalanche is allowed as long as  $T_{jmax}$  is not exceeded.
3. Equation below based on circuit and waveforms shown in Figures 12a, 12b.
4.  $P_{D(ave)}$  = Average power dissipation per single avalanche pulse.
5. BV = Rated breakdown voltage (1.3 factor accounts for voltage increase during avalanche).
6.  $I_{av}$  = Allowable avalanche current.
7.  $\Delta T$  = Allowable rise in junction temperature, not to exceed  $T_{jmax}$  (assumed as 25°C in Figure 15, 16).  
 $t_{av}$  = Average time in avalanche.  
 $D$  = Duty cycle in avalanche =  $t_{av} \cdot f$   
 $Z_{thJC}(D, t_{av})$  = Transient thermal resistance, see figure 11)

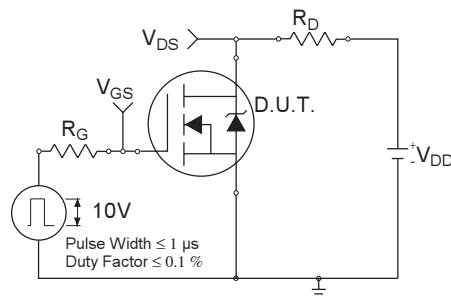
$$P_{D(ave)} = 1/2 ( 1.3 \cdot BV \cdot I_{av} ) = \Delta T / Z_{thJC}$$

$$I_{av} = 2\Delta T / [1.3 \cdot BV \cdot Z_{th}]$$

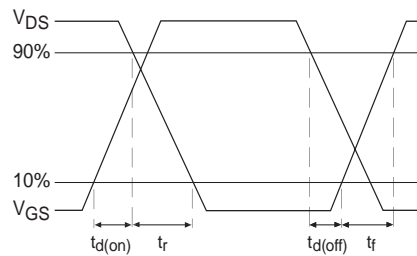
$$E_{AS(AR)} = P_{D(ave)} \cdot t_{av}$$



**Fig 17. Peak Diode Recovery  $dv/dt$  Test Circuit for N-Channel HEXFET® Power MOSFETs**



**Fig 18a. Switching Time Test Circuit**

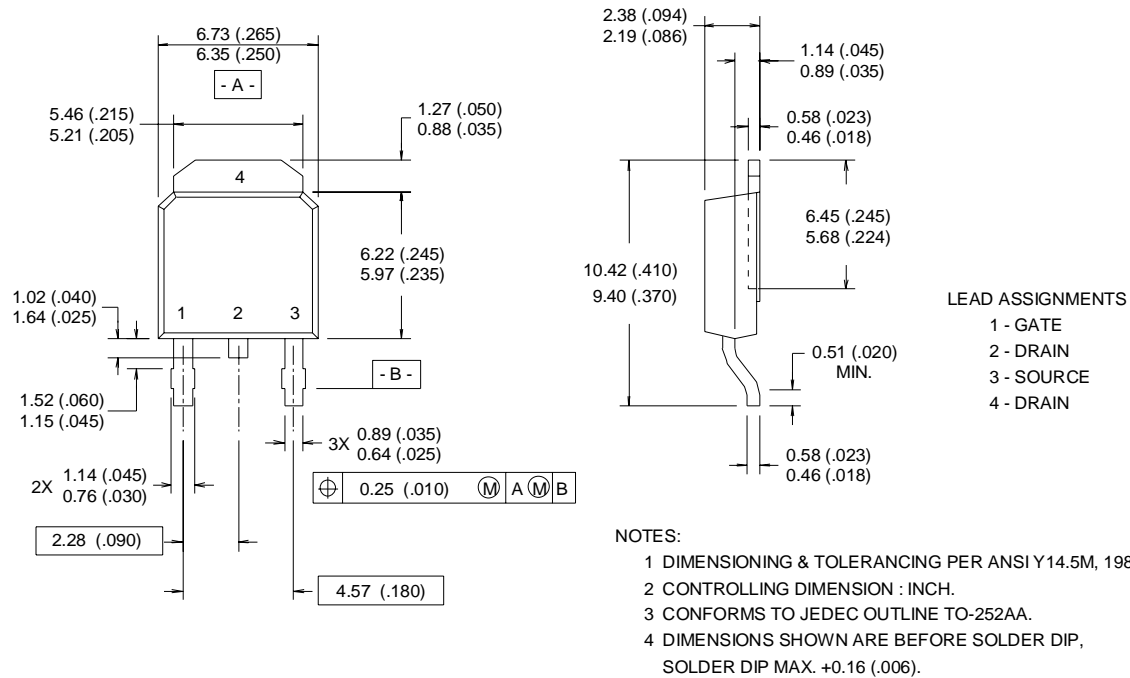


**Fig 18b. Switching Time Waveforms**



## D-Pak (TO-252AA) Package Outline

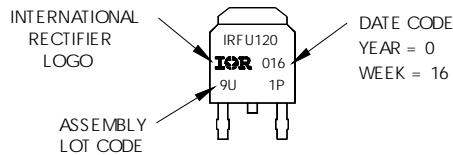
Dimensions are shown in millimeters (inches)



## D-Pak (TO-252AA) Part Marking Information

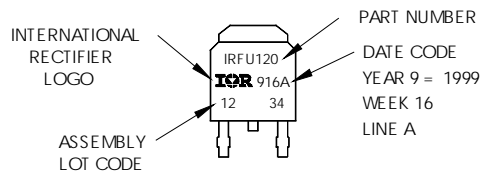
Notes: This part marking information applies to devices produced before 02/26/2001

EXAMPLE: THIS IS AN IRFR120  
WITH ASSEMBLY  
LOT CODE 9U1P



Notes: This part marking information applies to devices produced after 02/26/2001

EXAMPLE: THIS IS AN IRFR120  
WITH ASSEMBLY  
LOT CODE 1234  
ASSEMBLED ON WW 16, 1999  
IN THE ASSEMBLY LINE "A"

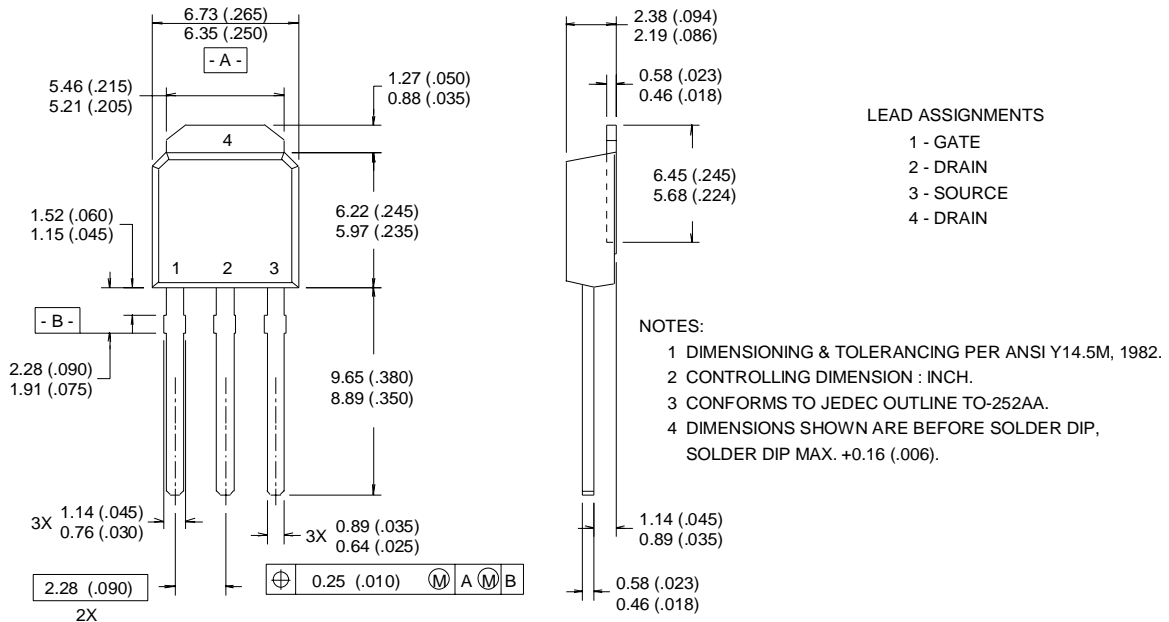


# IRFR/U4104

## I-Pak (TO-251AA) Package Outline

Dimensions are shown in millimeters (inches)

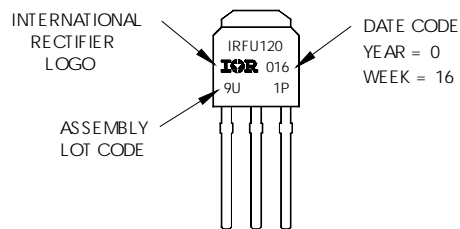
International  
**IR** Rectifier



## I-Pak (TO-251AA) Part Marking Information

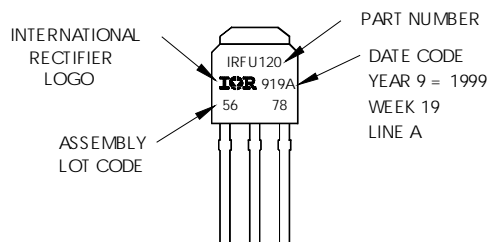
Notes: This part marking information applies to devices produced before 02/26/2001

EXAMPLE: THIS IS AN IRFR120  
WITH ASSEMBLY  
LOT CODE 9U1P



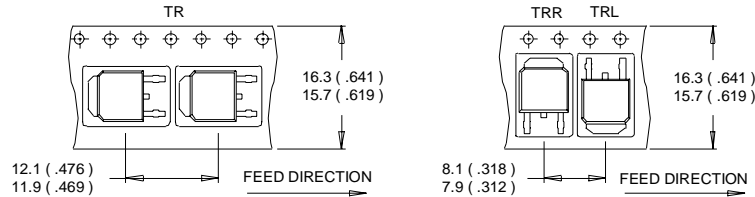
Notes: This part marking information applies to devices produced after 02/26/2001

EXAMPLE: THIS IS AN IRFR120  
WITH ASSEMBLY  
LOT CODE 5678  
ASSEMBLED ON WW 19, 1999  
IN THE ASSEMBLY LINE "A"

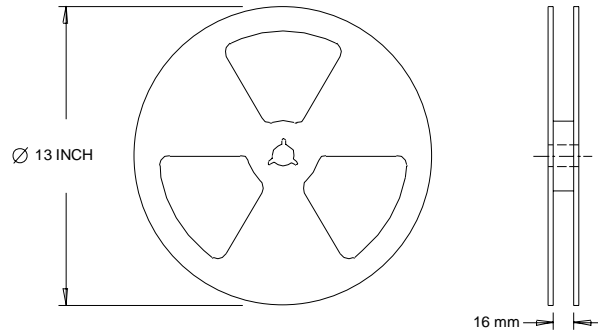


## D-Pak (TO-252AA) Tape & Reel Information

Dimensions are shown in millimeters (inches)



- NOTES :
1. CONTROLLING DIMENSION : MILLIMETER.
  2. ALL DIMENSIONS ARE SHOWN IN MILLIMETERS ( INCHES ).
  3. OUTLINE CONFORMS TO EIA-481 & EIA-541.



- NOTES :
1. OUTLINE CONFORMS TO EIA-481.

### Notes:

- ① Repetitive rating; pulse width limited by max. junction temperature. (See fig. 11).
- ② Limited by  $T_{Jmax}$ , starting  $T_J = 25^\circ\text{C}$ ,  $L = 0.16\text{mH}$ ,  $R_G = 25\Omega$ ,  $I_{AS} = 42\text{A}$ ,  $V_{GS} = 10\text{V}$ . Part not recommended for use above this value.
- ③ Pulse width  $\leq 1.0\text{ms}$ ; duty cycle  $\leq 2\%$ .
- ④  $C_{OSS}$  eff. is a fixed capacitance that gives the same charging time as  $C_{OSS}$  while  $V_{DS}$  is rising from 0 to 80%  $V_{DSS}$ .
- ⑤ Limited by  $T_{Jmax}$ , see Fig.12a, 12b, 15, 16 for typical repetitive avalanche performance.
- ⑥ This value determined from sample failure population. 100% tested to this value in production.
- ⑦ When mounted on 1" square PCB (FR-4 or G-10 Material). For recommended footprint and soldering techniques refer to application note #AN-994

Data and specifications subject to change without notice.  
This product has been designed and qualified for the Automotive [Q101] market.  
Qualification Standards can be found on IR's Web site.

International  
IR Rectifier

IR WORLD HEADQUARTERS: 233 Kansas St., El Segundo, California 90245, USA Tel: (310) 252-7105  
TAC Fax: (310) 252-7903

Visit us at [www.irf.com](http://www.irf.com) for sales contact information.7/03

Note: For the most current drawings please refer to the IR website at:  
<http://www.irf.com/package/>