

2nd Generation thinQ!TM SiC Schottky Diode

Features

- Revolutionary semiconductor material - Silicon Carbide
- Switching behavior benchmark
- No reverse recovery/ No forward recovery
- No temperature influence on the switching behavior
- High surge current capability
- Pb-free lead plating; RoHS compliant
- Qualified according to JEDEC¹⁾ for target applications
- Breakdown voltage tested at 5mA²⁾

Product Summary

V_{DC}	600	V
Q_c	15	nC
I_F	6	A

D²PAK (PG-TO263-3-2)

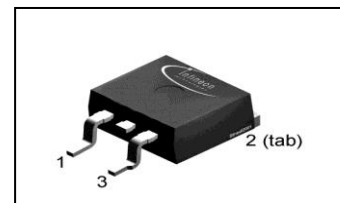

thinQ! 2G Diode designed for fast switching applications like:

- CCM PFC
- Motor Drives

Type	Package	Marking	Pin 2	Pin 3
IDB06S60C	D2PAK (PG-TO263-3-2)	D06S60C	C	A

Maximum ratings, at $T_j=25\text{ °C}$, unless otherwise specified

Parameter	Symbol	Conditions	Value	Unit
Continuous forward current	I_F	$T_C < 135\text{ °C}$	6	A
RMS forward current	$I_{F,RMS}$	$f=50\text{ Hz}$	9	
Surge non-repetitive forward current, sine halfwave	$I_{F,SM}$	$T_C=25\text{ °C}, t_p=10\text{ ms}$	46	
Repetitive peak forward current	$I_{F,RM}$	$T_j=150\text{ °C}, T_C=100\text{ °C}, D=0.1$	24	
Non-repetitive peak forward current	$I_{F,max}$	$T_C=25\text{ °C}, t_p=10\text{ }\mu\text{s}$	210	
i^2t value	$\int i^2 dt$	$T_C=25\text{ °C}, t_p=10\text{ ms}$	10	A ² s
Repetitive peak reverse voltage	V_{RRM}		600	V
Diode ruggedness dv/dt	dv/dt	$V_R=0\dots 480\text{V}$	50	V/ns
Power dissipation	P_{tot}	$T_C=25\text{ °C}$	52	W
Operating and storage temperature	T_j, T_{stg}		-55 ... 175	°C

Parameter	Symbol	Conditions	Values			Unit
			min.	typ.	max.	

Thermal characteristics

Thermal resistance, junction - case	R_{thJC}		-	-	2.9	K/W
Thermal resistance, junction - ambient	R_{thJA}	SMD version, device on PCB, minimal Footprint	-	-	62	
		SMD version, device on PCB, 6 cm ² cooling area ³⁾	-	35	-	
Soldering temperature, reflowsoldering @ 10sec	T_{sold}	reflow MSL1	-	-	260	°C

Electrical characteristics, at $T_j=25$ °C, unless otherwise specified
Static characteristics

DC blocking voltage	V_{DC}	$I_R=0.08$ mA	600	-	-	V
Diode forward voltage	V_F	$I_F=6$ A, $T_j=25$ °C	-	1.5	1.7	
		$I_F=6$ A, $T_j=150$ °C	-	1.7	2.1	
Reverse current	I_R	$V_R=600$ V, $T_j=25$ °C	-	0.7	80	µA
		$V_R=600$ V, $T_j=150$ °C	-	3	800	

AC characteristics

Total capacitive charge	Q_c	$V_R=400$ V, $I_F \leq I_{F,max}$, $di_F/dt=200$ A/µs, $T_j=150$ °C	-	15	-	nC
Switching time ⁴⁾	t_c		-	-	<10	ns
Total capacitance	C	$V_R=1$ V, $f=1$ MHz	-	280	-	pF
		$V_R=300$ V, $f=1$ MHz	-	35	-	
		$V_R=600$ V, $f=1$ MHz	-	35	-	

¹⁾ J-STD20 and JESD22

²⁾ All devices tested under avalanche conditions, for a time periode of 5ms at 5mA.

³⁾ Device on 40mm*40mm*1.5mm epox PCB FR4 with 6cm² (one layer, 70µm thick) copper area for drain connection. PCB is vertikal with out blown air.

⁴⁾ t_c is the time constant for the capacitive displacement current waveform (independent from T_j , I_{LOAD} and di/dt), different from t_{rr} , which is dependent on T_j , I_{LOAD} , di/dt . No reverse recovery time constant t_{rr} due to absence of minority carrier injection.

⁵⁾ Only capacitive charge occuring, guaranteed by design.

1 Power dissipation

$P_{tot}=f(T_C)$

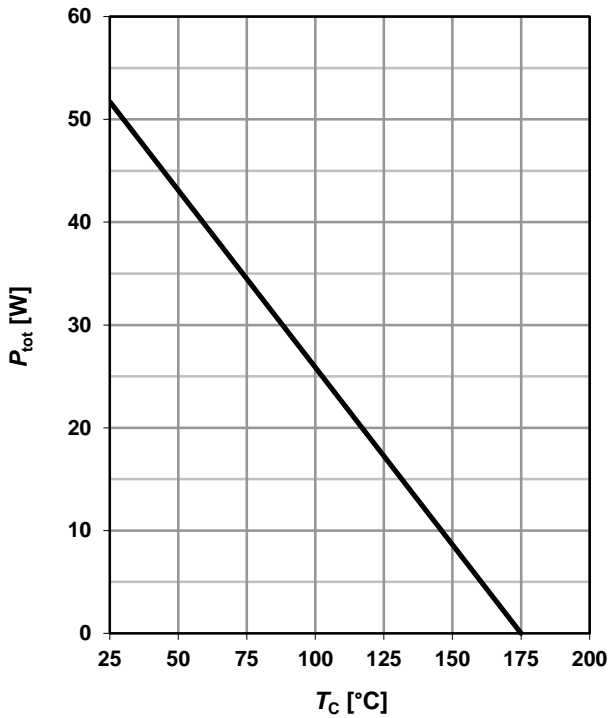

2 Diode forward current

$I_F=f(T_C); T_j \leq 175 \text{ °C}$

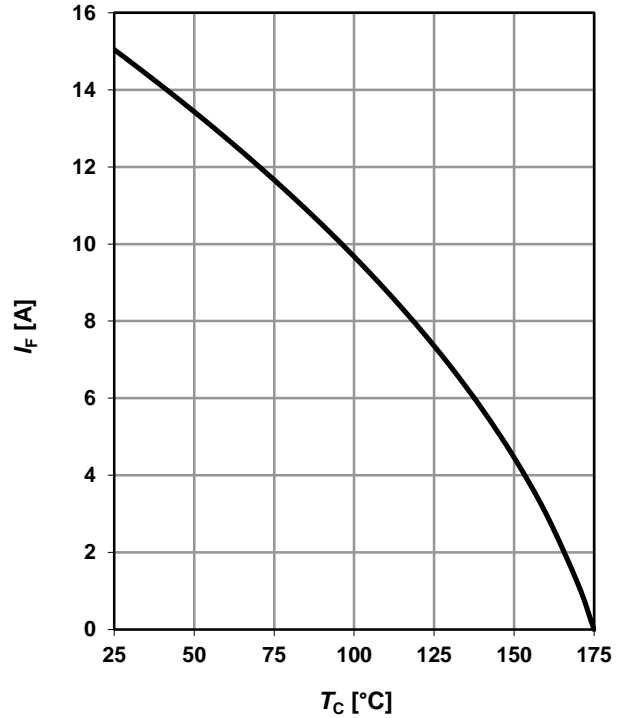

3 Typ. forward characteristic

$I_F=f(V_F); t_p=400 \text{ }\mu\text{s}$

parameter: T_j

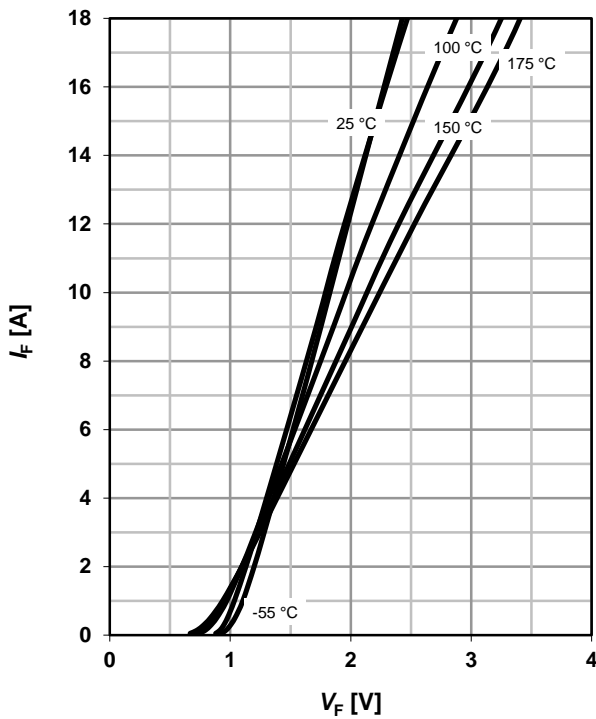

4 Typ. forward characteristic in surge current mode

$I_F=f(V_F); t_p=400 \text{ }\mu\text{s};$ parameter T_j

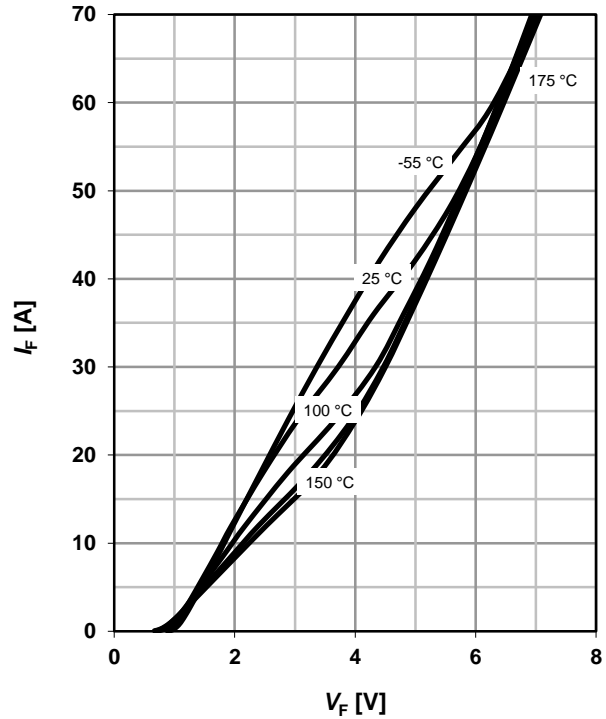

5 Typ. forward power dissipation vs. average forward current

$P_{F(AV)} = f(I_F)$, $T_C = 100\text{ °C}$, parameter: $D = t_p/T$

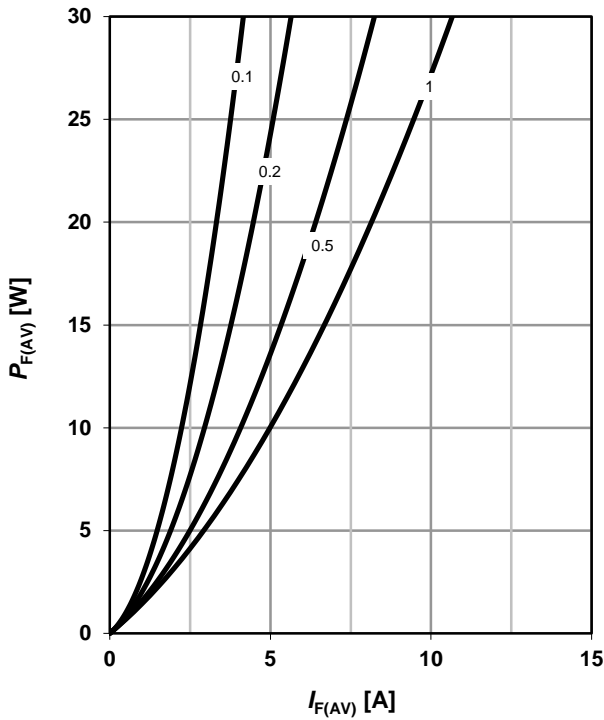

6 Typ. reverse current vs. reverse voltage

$I_R = f(V_R)$

parameter: T_j

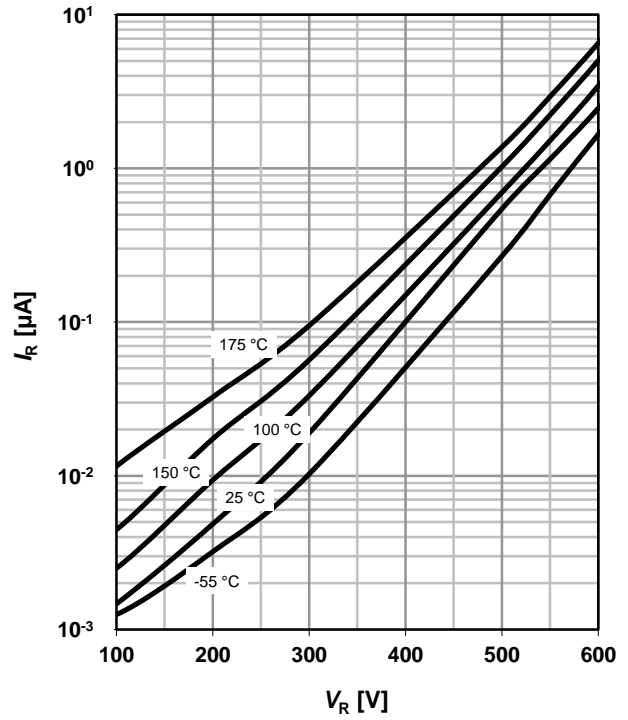

7 Transient thermal impedance

$Z_{thJC} = f(t_p)$

parameter: $D = t_p/T$

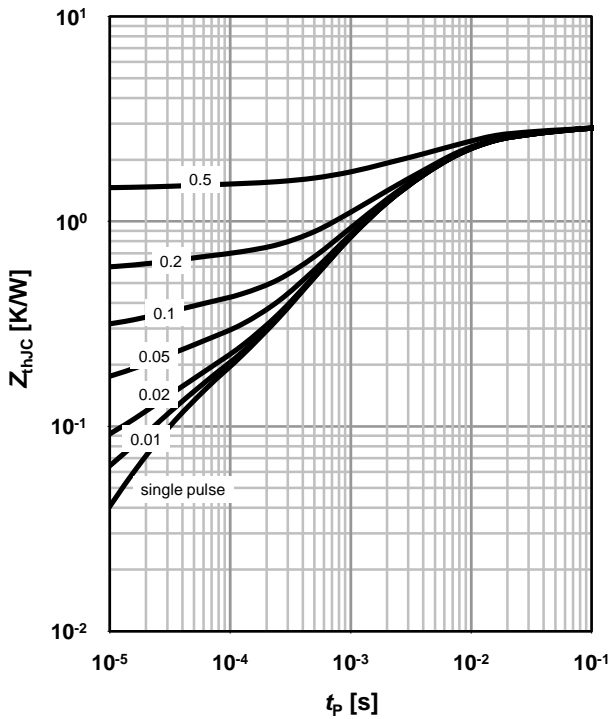

8 Typ. capacitance vs. reverse voltage

$C = f(V_R)$; $T_C = 25\text{ °C}$, $f = 1\text{ MHz}$

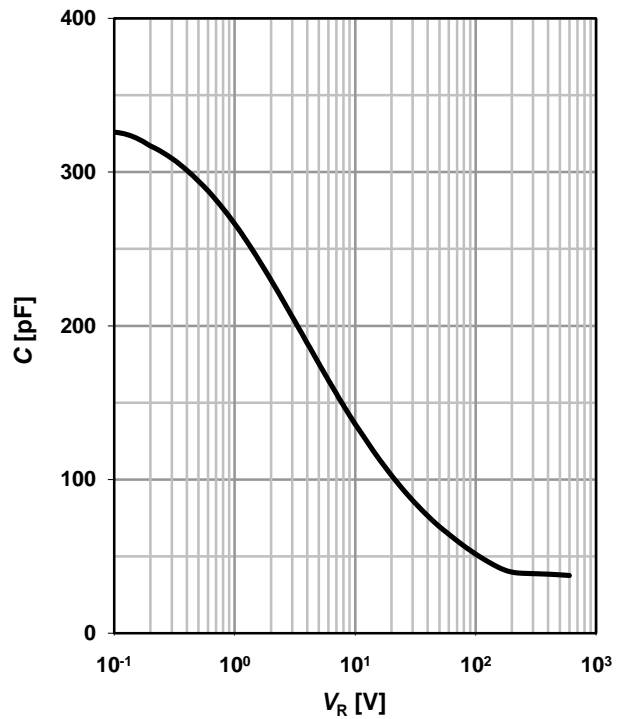

9 Typ. C stored energy

$$E_C = f(V_R)$$

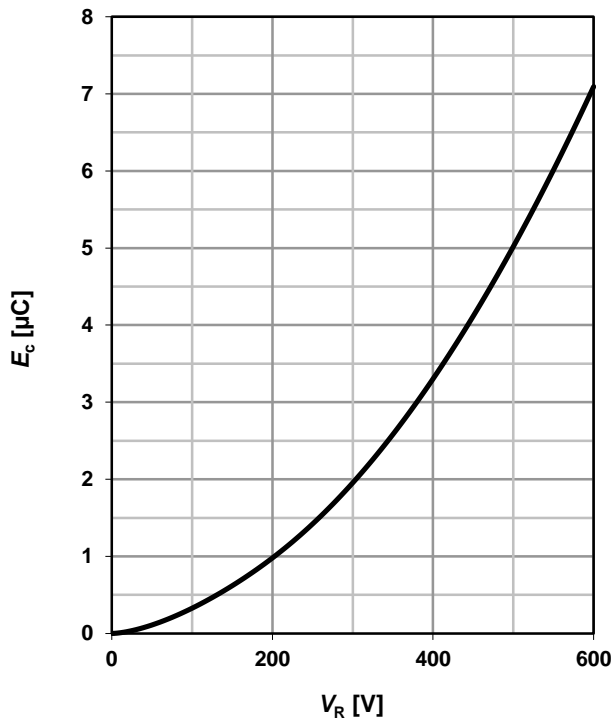

10 Typ. capacitance charge vs. current slope

$$Q_C = f(di_F/dt)^5; T_j = 150 \text{ }^\circ\text{C}; I_F \leq I_{F,max}$$

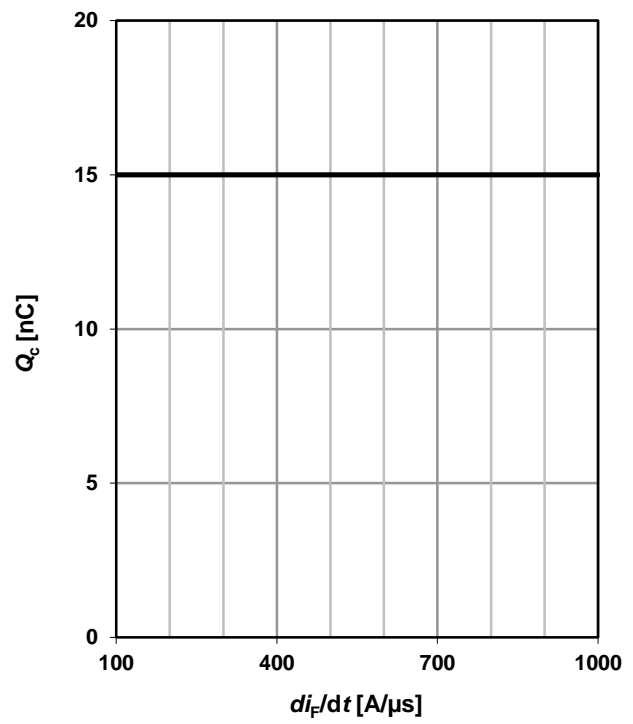

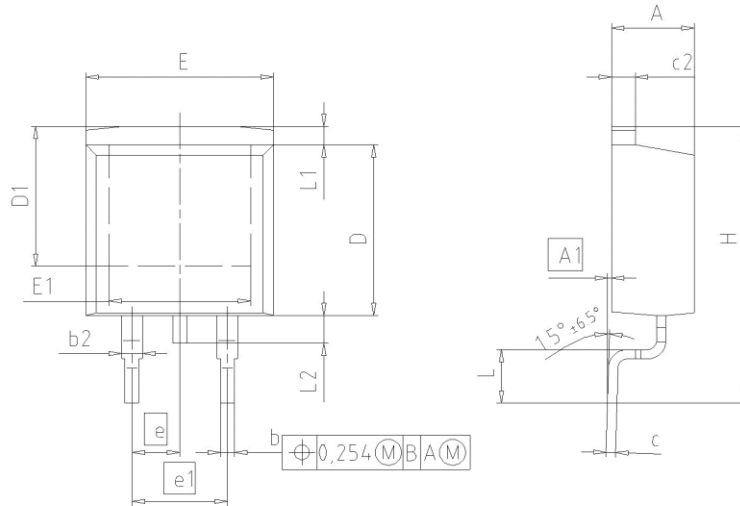
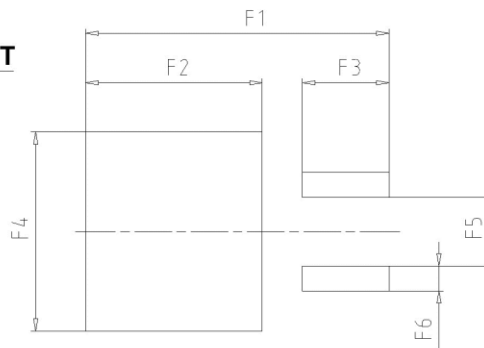
PG-TO263-3-2 (D2Pak): Outline

FOOTPRINT

DIM	MILLIMETERS		INCHES	
	MIN	MAX	MIN	MAX
A	4.30	4.57	0.169	0.180
A1	0.00	0.25	0.000	0.010
b	0.65	0.85	0.026	0.033
b2	0.95	1.15	0.037	0.045
c	0.33	0.65	0.013	0.026
c2	1.17	1.40	0.046	0.055
D	8.51	9.45	0.335	0.372
D1	7.10	7.90	0.280	0.311
E	9.80	10.31	0.386	0.406
E1	6.50	8.60	0.256	0.339
e	2.54		0.100	
e1	5.08		0.200	
N	2		2	
H	14.61	15.88	0.575	0.625
L	2.29	3.00	0.090	0.118
L1	0.70	1.60	0.028	0.063
L2	1.00	1.78	0.039	0.070
F1	16.05	16.25	0.632	0.640
F2	9.30	9.50	0.366	0.374
F3	4.50	4.70	0.177	0.185
F4	10.70	10.90	0.421	0.429
F5	3.65	3.85	0.144	0.152
F6	1.25	1.45	0.049	0.057

DOCUMENT NO.
Z8B00003324

SCALE

EUROPEAN PROJECTION

ISSUE DATE
30-08-2007

REVISION
01

Dimensions in mm/inches

Published by
Infineon Technologies AG
81726 Munich, Germany
© 2007 Infineon Technologies AG
All Rights Reserved.

Legal Disclaimer

The information given in this document shall in no event be regarded as a guarantee of conditions or characteristics. With respect to any examples or hints given herein, any typical values stated herein and/or any information regarding the application of the device, Infineon Technologies hereby disclaims any and all warranties and liabilities of any kind, including without limitation, warranties of non-infringement of intellectual property rights of any third party.

Information

For further information on technology, delivery terms and conditions and prices, please contact the nearest Infineon Technologies Office (www.infineon.com).

Warnings

Due to technical requirements, components may contain dangerous substances. For information on the types in question, please contact the nearest Infineon Technologies Office. Infineon Technologies components may be used in life-support devices or systems only with the express written approval of Infineon Technologies, if a failure of such components can reasonably be expected to cause the failure of that life-support device or system or to affect the safety or effectiveness of that device or system. Life support devices or systems are intended to be implanted in the human body or to support and/or maintain and sustain and/or protect human life. If they fail, it is reasonable to assume that the health of the user or other persons may be endangered.