

European Power-Semiconductor and Electronics Company GmbH + Co. KG

Leistungsgleichrichterioden Power Rectifier Diodes D 121 K

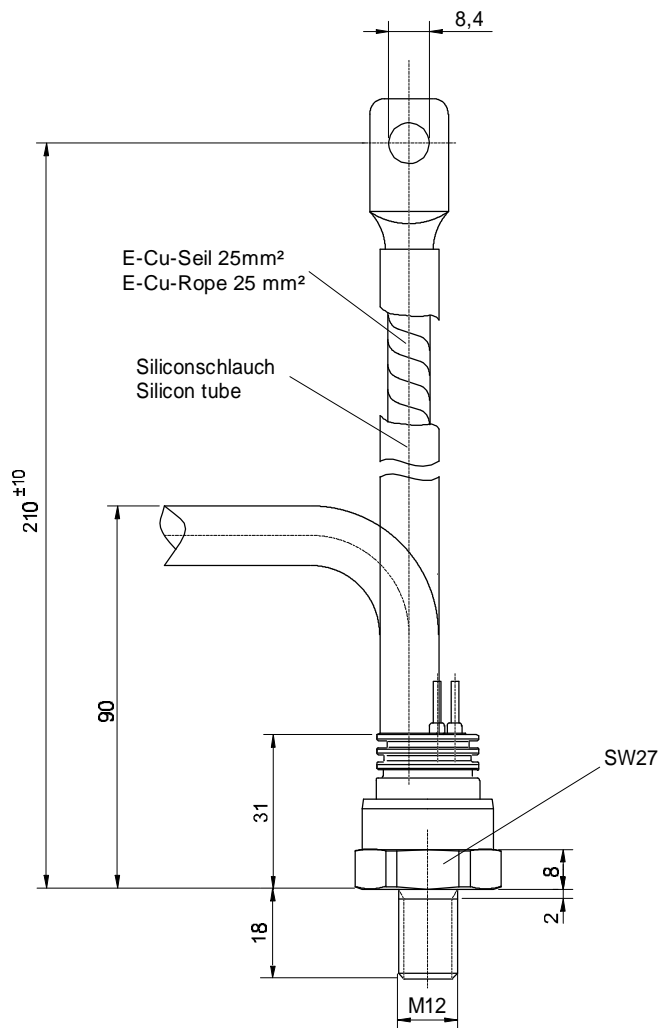

Typ Type	Schalt-symbol Circuit symbol	Kathode Cathode	Anode Anode	Schutzschlauch Prot. flex. tubing
D121N		Seil Rope	Gewinde Thread	rot red
D121K		Gewinde Thread	Seil Rope	blau blue

VWK July 1996

D 121 K

Elektrische Eigenschaften

Electrical properties

Höchstzulässige Werte

Maximum rated values

Periodische Spitzensperrspannung	repetitive peak reverse voltage	$t_{vj} = -40^{\circ}\text{C} \dots t_{vj \max}$	V_{RRM}	800, 1200, 1400 1800, 2000	V V
Stoßspitzensperrspannung	non-repetitive peak reverse voltage	$t_{vj} = +25^{\circ}\text{C} \dots t_{vj \max}$	$V_{RSM} = V_{RRM}$	+ 100	V
Durchlaßstrom-Grenzeffektivwert	RMS forward current		I_{FRMSM}	330	A
Dauergrenzstrom	mean forward current	$t_c = 113^{\circ}\text{C}$ $t_c = 25^{\circ}\text{C}$	I_{FAVM}	120 210	A A
Stoßstrom-Grenzwert	surge forward current	$t_{vj} = 25^{\circ}\text{C}, t_p = 10 \text{ ms}$ $t_{vj} = t_{vj \max}, t_p = 10 \text{ ms}$	I_{FSM}	2,85 2,4	kA kA
Grenzlastintegral	$I^2 t$ -value	$t_{vj} = 25^{\circ}\text{C}, t_p = 10 \text{ ms}$ $t_{vj} = t_{vj \max}, t_p = 10 \text{ ms}$	$I^2 t$	40,6 28,8	A^2s A^2s

Charakteristische Werte

Characteristic values

Durchlaßspannung	on-state voltage	$t_{vj} = t_{vj \max}, I_F = 650 \text{ A}$	V_T	max.	2,04	V
Schleusenspannung	threshold voltage	$t_{vj} = t_{vj \max}$	$V_{T(TO)}$		0,72	V
Ersatzwiderstand	slope resistance	$t_{vj} = t_{vj \max}$	r_T		1,9	$\text{m}\Omega$
Sperrstrom	reverse current	$t_{vj} = t_{vj \max}, V_R = V_{RRM}$	I_R	max.	20	mA

Thermische Eigenschaften

Thermal properties

Innerer Widerstand	thermal resistance, junction	$\Theta = 180^{\circ} \text{ sin}$	R_{thJC}	max.	0,434	$^{\circ}\text{C}/\text{W}$
	to case	DC		max.	0,420	$^{\circ}\text{C}/\text{W}$
Übergangs-Wärmewiderstand	thermal resistance, case to heatsink		R_{thCK}	max.	0,04	$^{\circ}\text{C}/\text{W}$
Höchstzul. Sperrschichttemperatur	max. junction temperature		$t_{vj \max}$		180	$^{\circ}\text{C}$
Betriebstemperatur	operating temperature		$t_{c \text{ op}}$		-40...+180	$^{\circ}\text{C}$
Lagertemperatur	storage temperature		t_{stg}		-40...+180	$^{\circ}\text{C}$

Mechanische Eigenschaften

Mechanical properties

Si-Element mit Druckkontakt	Si-pellet with pressure contact	$\varnothing = 15 \text{ mm}$				
Anzugsdrehmoment	tightening torque	Gehäuseform/case design B	M1		20	Nm
Gewicht	weight		G	typ.	175	g
Kriechstrecke	creepage distance				12	mm
Feuchteklasse	humidity classification	DIN 40040				C
Schwingfestigkeit	vibration resistance	$f = 50 \text{ Hz}$			50	m/s^2
Maßbild	outline				Seite/page	
Polarität	polarity				Kathode=Gehäuse/case	

D 121 K

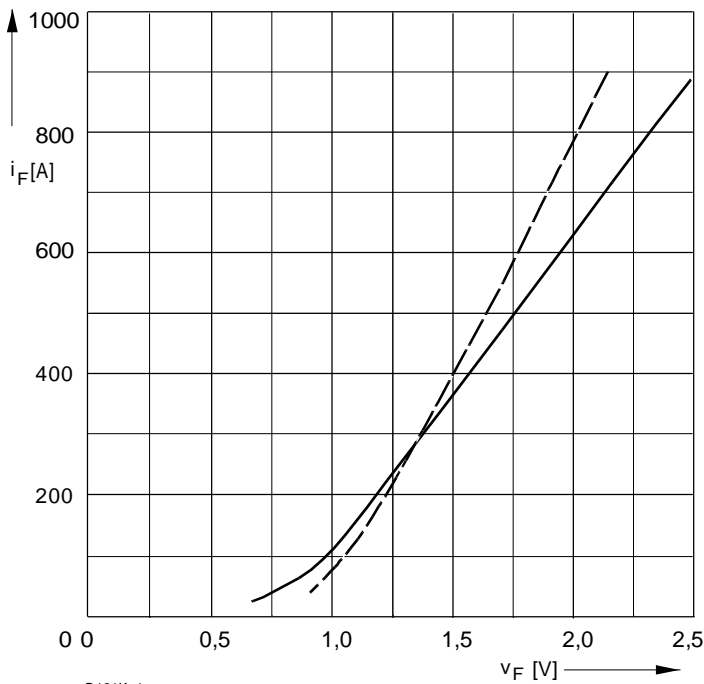

D121K_1

Bild / Fig. 1
Grenzdurchlaßkennlinie
 Limiting forward characteristic $i_F = f(v_F)$
 — $t_j = 180\text{ °C}$
 - - - $t_j = 25\text{ °C}$

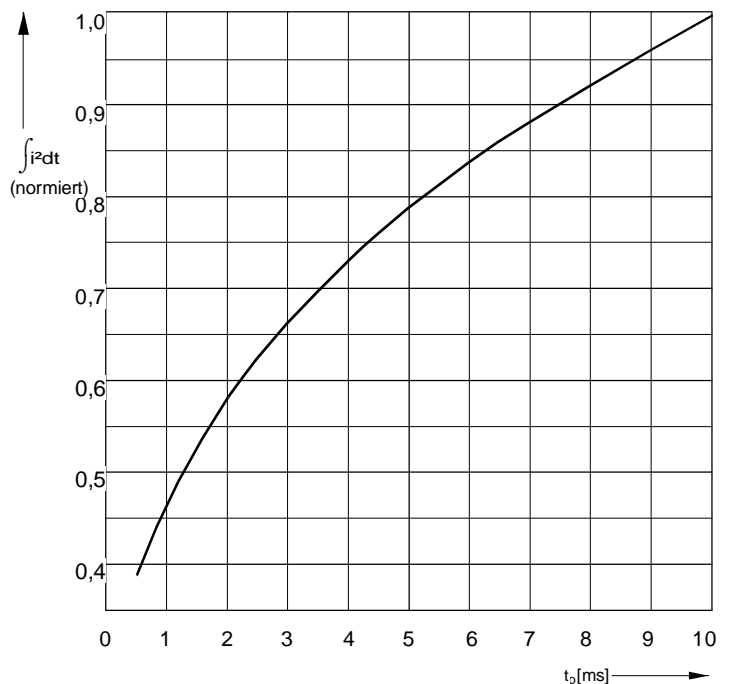

D121K_4

Bild / Fig. 2
Normiertes Grenzlastintegral / Normalized i^2t
 $\int i^2 dt = f(t_p)$

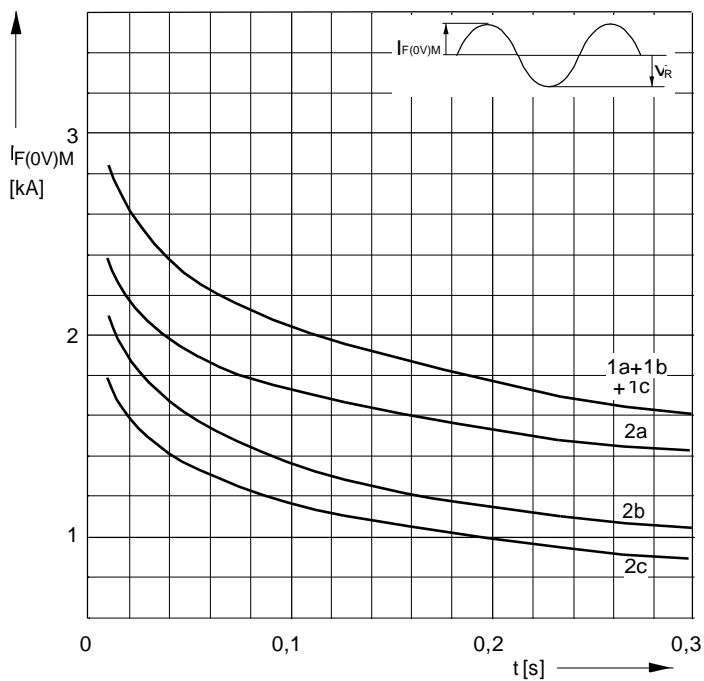

D121K_5

Bild / Fig. 3
Grenzstrom / Maximum overload forward current $I_{F(OV)M} = f(t)$
 1 - $I_{FAV(vor)} = 0\text{ A}$; $t_j = t_c = 25\text{ °C}$
 2 - $I_{FAV(vor)} = 120\text{ A}$; $t_c = 113\text{ °C}$; $t_j = 180\text{ °C}$
 a - $v_R \leq 50\text{ V}$
 b - $v_R = 0,5\text{ V}_{RRM}$
 c - $v_R = 0,8\text{ V}_{RRM}$

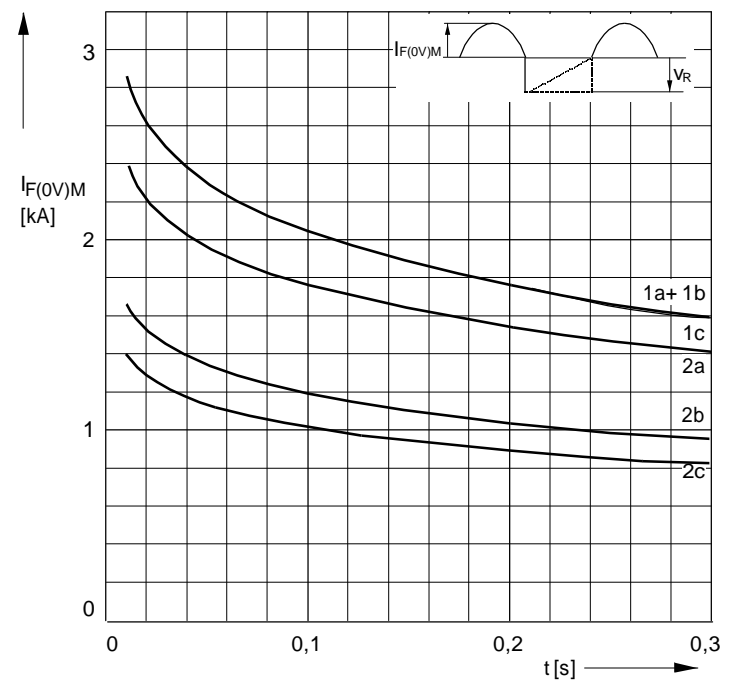

D121K_6

Bild / Fig. 4
Grenzstrom / Maximum overload forward current $I_{F(OV)M} = f(t)$
 1 - $I_{FAV(vor)} = 0\text{ A}$; $t_j = t_c = 25\text{ °C}$
 2 - $I_{FAV(vor)} = 120\text{ A}$; $t_c = 113\text{ °C}$; $t_j = 180\text{ °C}$
 a - $v_R \leq 50\text{ V}$
 b - $v_R = 0,5\text{ V}_{RRM}$
 c - $v_R = 0,8\text{ V}_{RRM}$

D 121 K

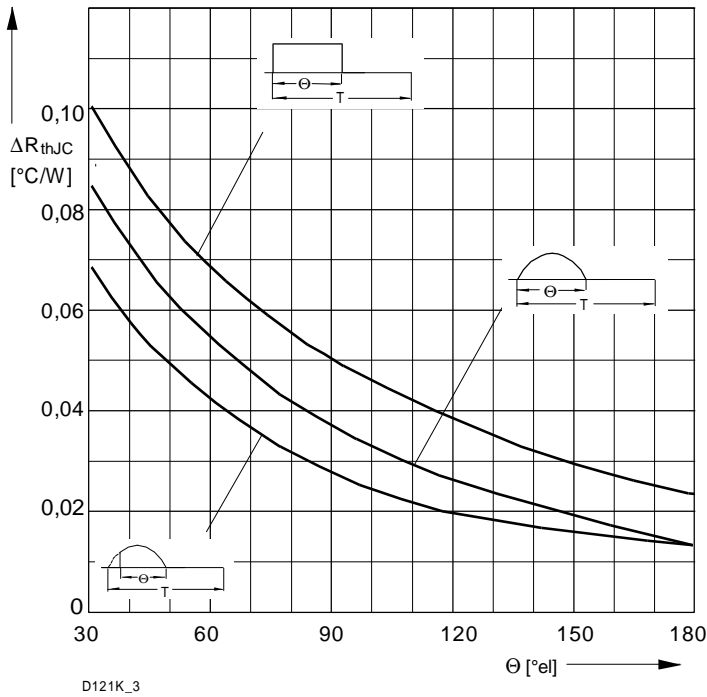

D121K_3

Bild / Fig. 5
 Differenz zwischen den Wärmewiderständen für Pulsstrom und DC
 Difference between the values of thermal resistance for pulse current and DC
 Parameter: Stromkurvenform / Current waveform

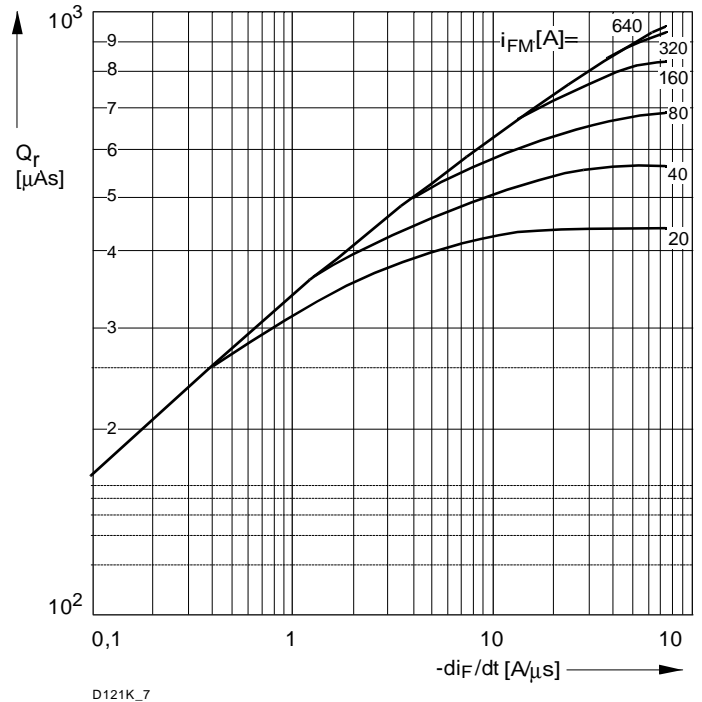

D121K_7

Bild / Fig. 6
 Sperrverzögerungsladung / Recovered charge $Q_r = f(-di_F/dt)$
 $t_{vj} = t_{vjmax}$; $v_R \leq 0,5 V_{RRM}$; $V_{RM} = 0,8 V_{RRM}$
 Beschaltung / Snubber: $C = 0,33 \mu F$; $R = 10 \Omega$
 Parameter: Durchlaßstrom / Forward current i_{FM}

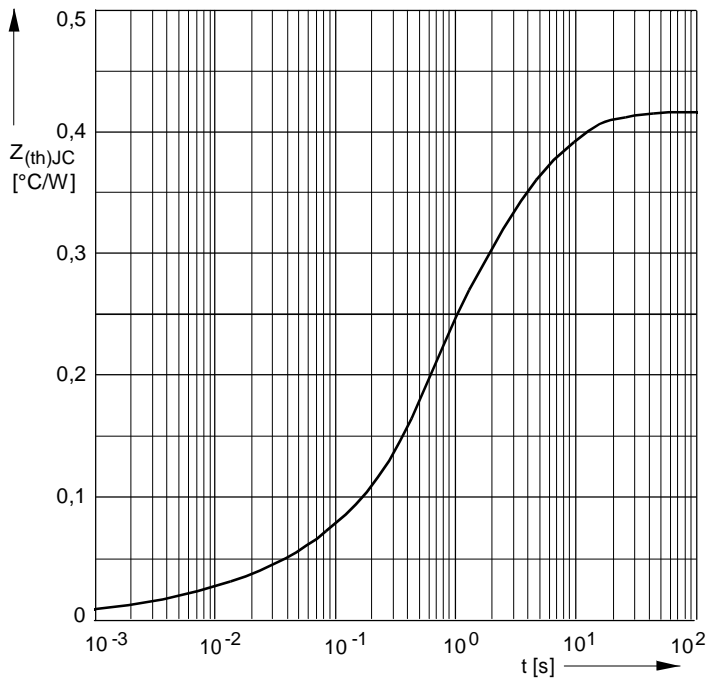

D121K_2

Bild / Fig. 7
 Transienter innerer Wärmewiderstand
 Transient thermal impedance $Z_{thJC} = f(t)$, DC
 1 - Beidseitige Kühlung / Two-sided cooling
 2 - Anodenseitige Kühlung / Anode-sided cooling
 3 - Kathodenseitige Kühlung / Cathode-sided cooling

Analytische Elemente des transienten Wärmewiderstandes Z_{thJC} für DC
 Analytical elements of transient thermal impedance Z_{thJC} for DC

Pos. n	1	2	3	4	5	6	7
R_{thn} °C/W	0,000052	0,003148	0,0101	0,0274	0,0639	0,133	0,0724
t_n [s]	0,000009	0,000254	0,0029	0,0158	0,252	1,1	7,49

Analytische Funktion / Analytical function:

$$Z_{thJC} = \sum_{n=1}^{n_{max}} R_{thn} (1 - \text{EXP}(-t/t_n))$$

Terms & Conditions of Usage

Attention

The present product data is exclusively subscribed to technically experienced staff. This Data Sheet is describing the specification of the products for which a warranty is granted exclusively pursuant the terms and conditions of the supply agreement. There will be no guarantee of any kind for the product and its specifications. Changes to the Data Sheet are reserved.

You and your technical departments will have to evaluate the suitability of the product for the intended application and the completeness of the product data with respect to such application. Should you require product information in excess of the data given in the Data Sheet, please contact your local Sales Office via "www.eupec.com / sales & contact".

Warning

Due to technical requirements the products may contain dangerous substances. For information on the types in question please contact your local Sales Office via "www.eupec.com / sales & contact".