

## Thermally-Enhanced High Power RF LDMOS FETs 60 W, 2110 – 2170 MHz

### Description

The PTFA210601E and PTFA210601F are 60-watt LDMOS FETs designed for single- and two-carrier WCDMA power amplifier applications in the 2110 to 2170 MHz band. Features include input and output matching, and thermally-enhanced packages with slotted or earless flanges. Manufactured with Infineon's advanced LDMOS process, these devices provide excellent thermal performance and superior reliability.

PTFA210601E  
 Package H-36265-2

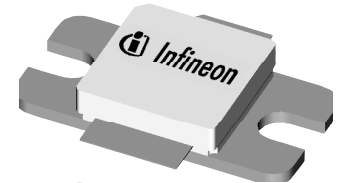

PTFA210601F  
 Package H-37265-2

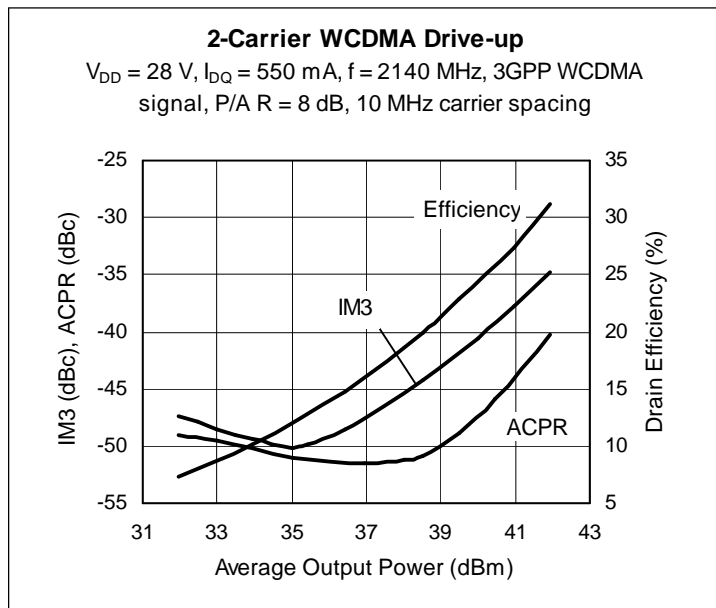

### Features

- Thermally-enhanced packages, Pb-free and RoHS-compliant
- Broadband internal matching
- Typical two-carrier WCDMA performance at 2140 MHz, 28 V
  - Average output power = 12 W
  - Linear Gain = 16 dB
  - Efficiency = 27.0%
  - Intermodulation distortion = -38 dBc
  - Adjacent channel power = -44 dBc
- Typical CW performance, 2170 MHz, 28 V
  - Output power at P-1dB = 68 W
  - Efficiency = 58.5%
- Integrated ESD protection: Human Body Model, Class 2 (minimum)
- Excellent thermal stability, low HCI drift
- Capable of handling 10:1 VSWR @ 28 V, 60 W (CW) output power

### RF Characteristics

#### WCDMA Measurements (tested in Infineon test fixture)

$V_{DD} = 28\text{ V}$ ,  $I_{DQ} = 550\text{ mA}$ ,  $P_{OUT} = 12\text{ W}$  average

$f_1 = 2135\text{ MHz}$ ,  $f_2 = 2145\text{ MHz}$ , 3GPP signal, channel bandwidth = 3.84 MHz, peak/average = 8 dB @ 0.01% CCDF

Characteristic	Symbol	Min	Typ	Max	Unit
Gain	$G_{ps}$	15.0	16.0	—	dB
Drain Efficiency	$\eta_D$	26.0	27.0	—	%
Intermodulation Distortion	IMD	—	-38	-37	dBc

All published data at  $T_{CASE} = 25^\circ\text{C}$  unless otherwise indicated

**ESD:** Electrostatic discharge sensitive device—observe handling precautions!

## RF Characteristics (cont.)

**Two-tone Measurements** (not subject to production test—verified by design/characterization in Infineon test fixture)

$V_{DD} = 28\text{ V}$ ,  $I_{DQ} = 550\text{ mA}$ ,  $P_{OUT} = 60\text{ W PEP}$ ,  $f = 2140\text{ MHz}$ , tone spacing = 1 MHz

Characteristic	Symbol	Min	Typ	Max	Unit
Gain	$G_{ps}$	—	16	—	dB
Drain Efficiency	$\eta_D$	—	42	—	%
Intermodulation Distortion	IMD	—	-28	—	dBc

## DC Characteristics

Characteristic	Conditions	Symbol	Min	Typ	Max	Unit
Drain-Source Breakdown Voltage	$V_{GS} = 0\text{ V}$ , $I_{DS} = 10\text{ mA}$	$V_{(BR)DSS}$	65	—	—	V
Drain Leakage Current	$V_{DS} = 28\text{ V}$ , $V_{GS} = 0\text{ V}$	$I_{DSS}$	—	—	1.0	$\mu\text{A}$
	$V_{DS} = 63\text{ V}$ , $V_{GS} = 0\text{ V}$	$I_{DSS}$	—	—	10.0	$\mu\text{A}$
On-State Resistance	$V_{GS} = 10\text{ V}$ , $V_{DS} = 0.1\text{ V}$	$R_{DS(on)}$	—	0.15	—	$\Omega$
Operating Gate Voltage	$V_{DS} = 28\text{ V}$ , $I_{DQ} = 550\text{ mA}$	$V_{GS}$	2.0	2.5	3.0	V
Gate Leakage Current	$V_{GS} = 10\text{ V}$ , $V_{DS} = 0\text{ V}$	$I_{GSS}$	—	—	1.0	$\mu\text{A}$

## Maximum Ratings

Parameter	Symbol	Value	Unit
Drain-Source Voltage	$V_{DSS}$	65	V
Gate-Source Voltage	$V_{GS}$	-0.5 to +12	V
Junction Temperature	$T_J$	200	$^{\circ}\text{C}$
Total Device Dissipation	$P_D$	196	W
		Above 25 $^{\circ}\text{C}$ derate by	1.12
Storage Temperature Range	$T_{STG}$	-40 to +150	$^{\circ}\text{C}$
Thermal Resistance ( $T_{CASE} = 70^{\circ}\text{C}$ , 60 W CW)	$R_{\theta JC}$	0.89	$^{\circ}\text{C}/\text{W}$

## Ordering Information

Type and Version	Package Type	Package Description	Marking
PTFA210601E V4	H-36265-2	Thermally-enhanced slotted flange, single-ended	PTFA210601E
PTFA210601F V4	H-37265-2	Thermally-enhanced earless flange, single-ended	PTFA210601F

**Typical Performance** (data taken in a production test fixture)

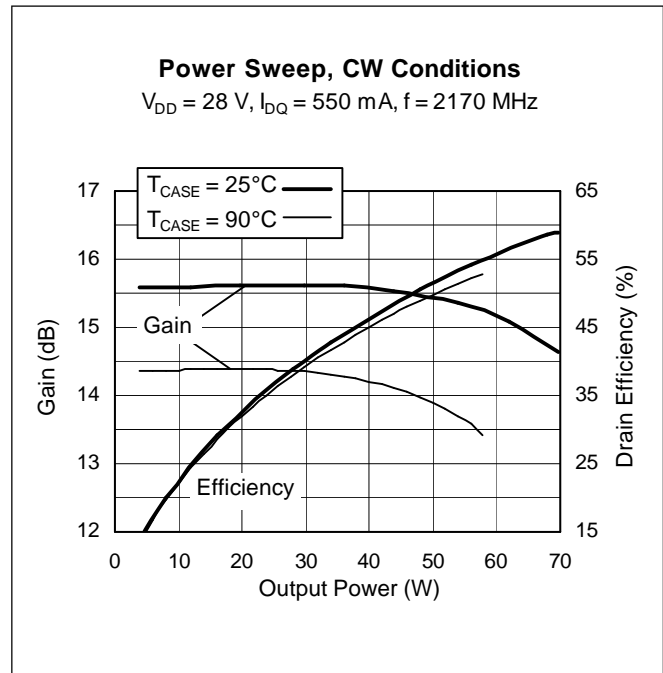
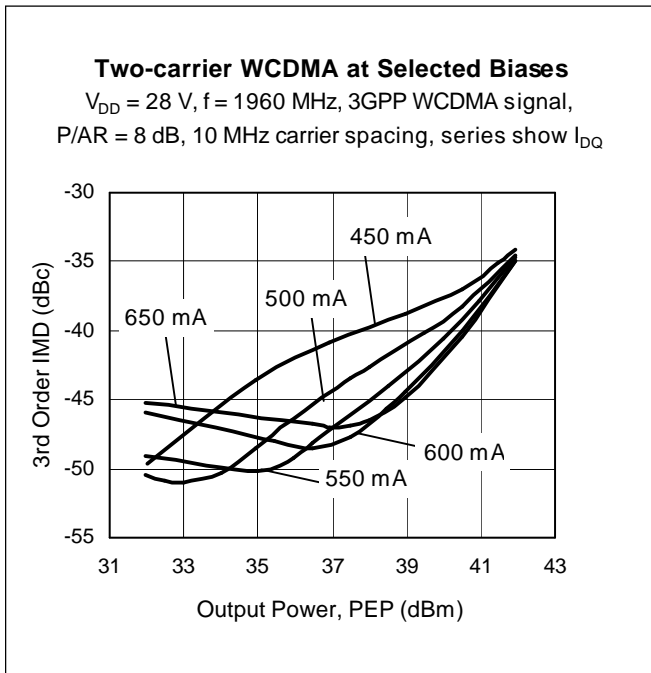
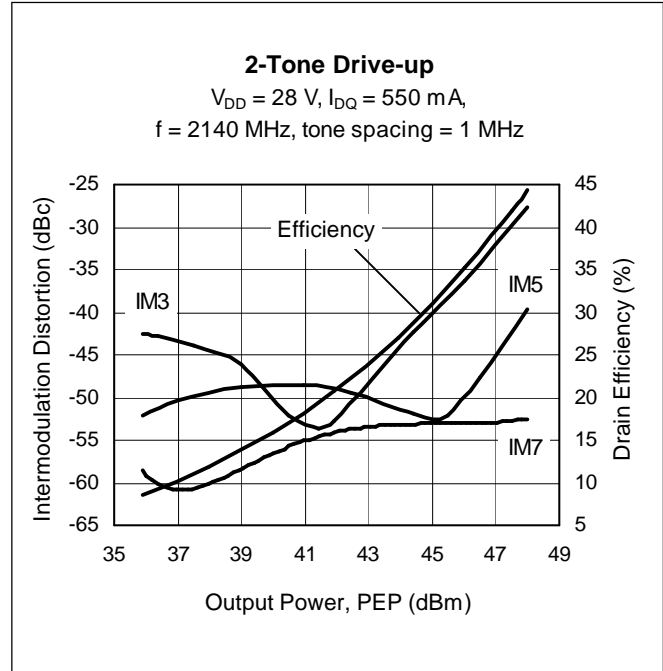
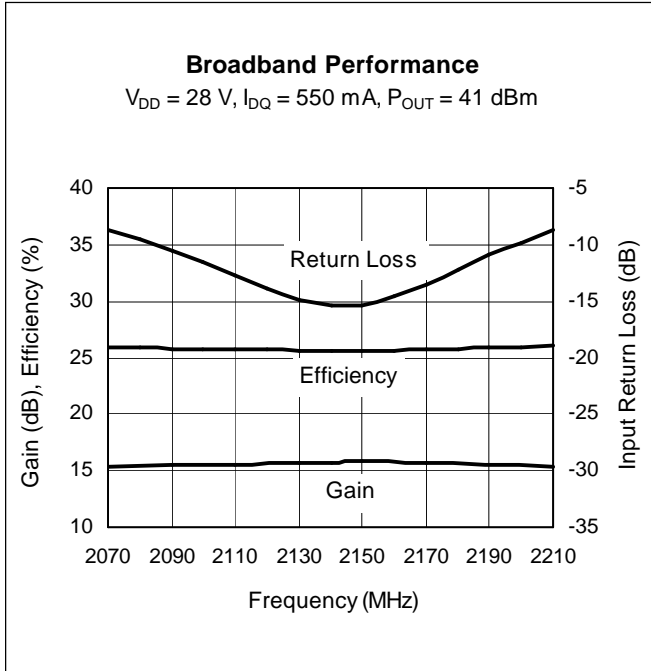

**Typical Performance (cont.)**

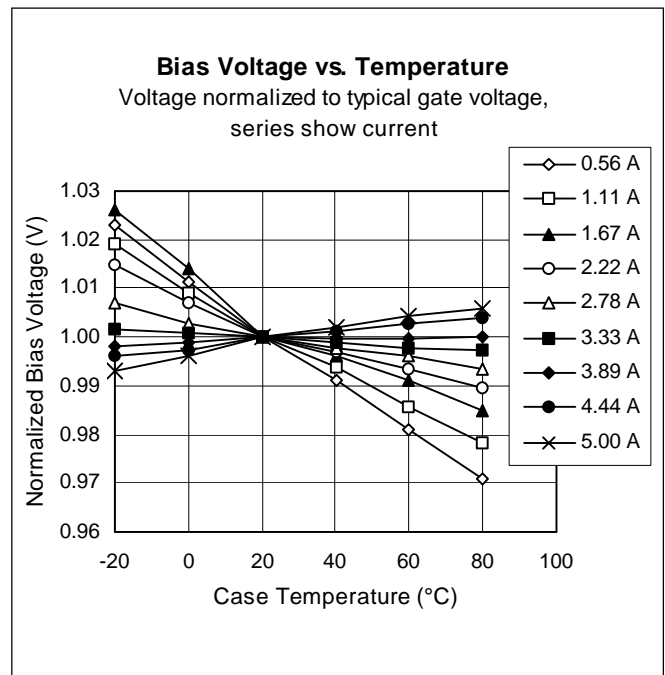
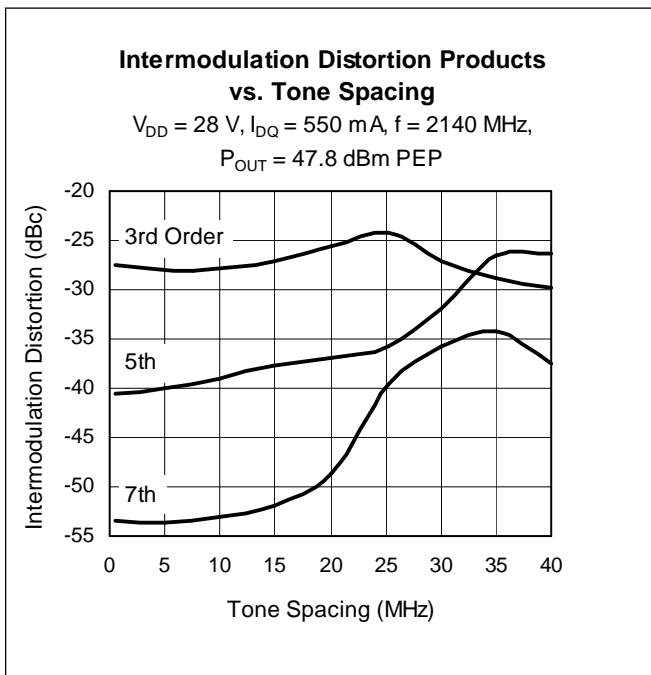
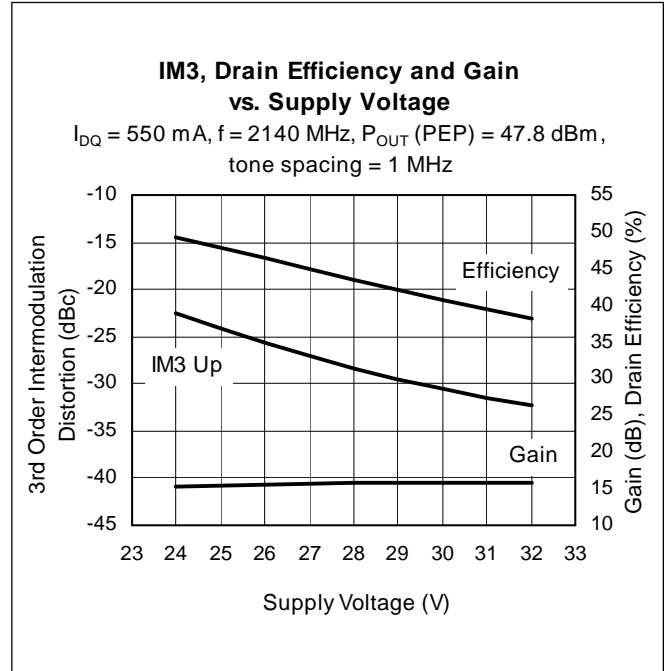
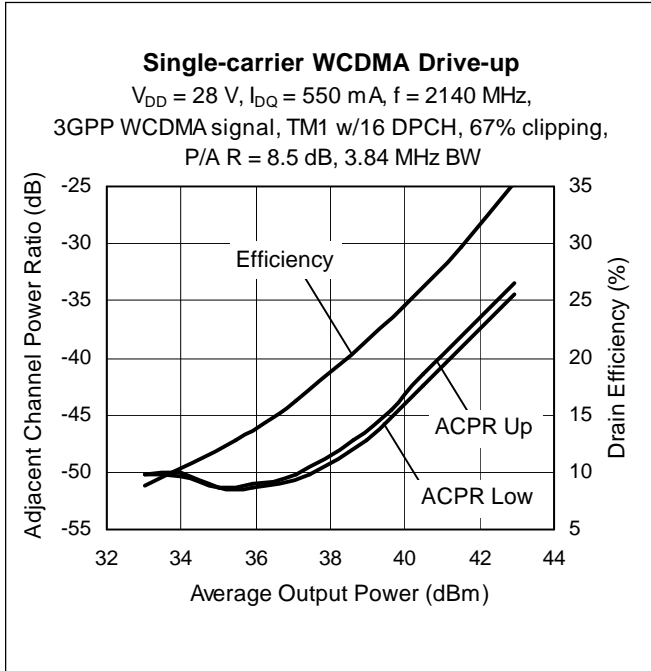

### Broadband Circuit Impedance

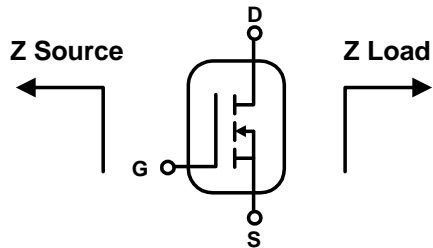

Frequency MHz	Z Source W		Z Load W	
	R	jX	R	jX
2070	10.29	-5.79	4.91	1.57
2110	9.46	-6.02	4.83	1.75
2140	8.79	-5.95	4.85	2.12
2170	8.14	-5.91	4.76	2.38
2210	7.19	-5.72	4.66	2.55

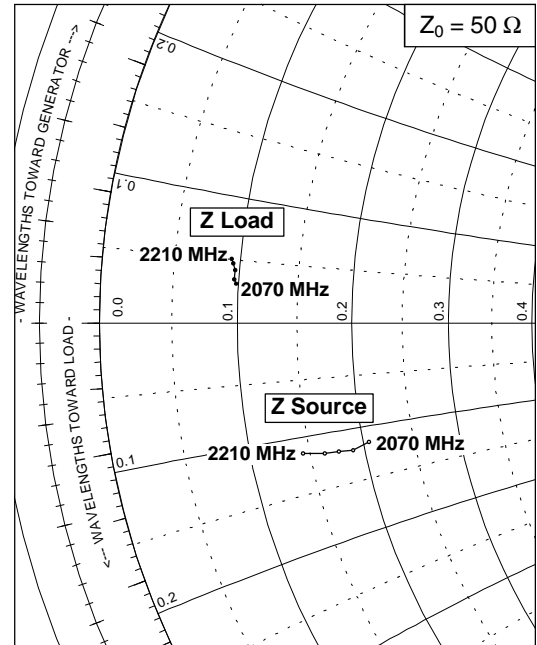

See next page for reference circuit information

### Reference Circuit

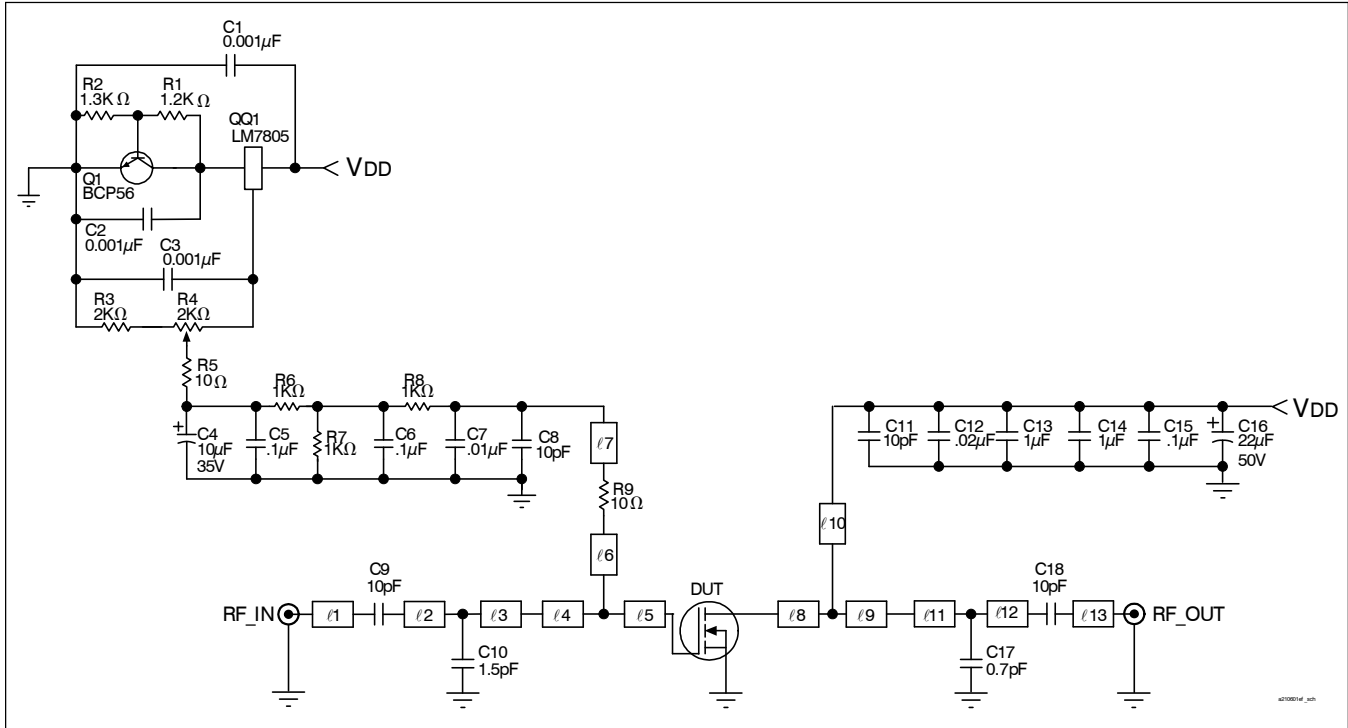

Reference circuit schematic for  $f = 2140$  MHz

### Circuit Assembly Information

DUT	PTFA210601E or PTFA210601F	LDMOS Transistor	
PCB	0.76 mm [.030"] thick, $\epsilon_r = 3.48$	Rogers 4350	1 oz. copper

Microstrip	Electrical Characteristics at 2140 MHz <sup>1</sup>	Dimensions: L x W (mm)	Dimensions: L x W (in.)
$l_1$	0.030 $\lambda$ , 50.0 $\Omega$	2.54 x 1.52	0.100 x 0.060
$l_2$	0.038 $\lambda$ , 50.0 $\Omega$	3.15 x 1.52	0.124 x 0.060
$l_3$	0.146 $\lambda$ , 50.0 $\Omega$	12.32 x 1.52	0.485 x 0.060
$l_4$	0.049 $\lambda$ , 6.2 $\Omega$	3.81 x 22.78	0.150 x 0.897
$l_5$	0.016 $\lambda$ , 6.2 $\Omega$	1.17 x 22.78	0.046 x 0.897
$l_6$	0.009 $\lambda$ , 80.0 $\Omega$	0.74 x 0.69	0.029 x 0.027
$l_7$	0.112 $\lambda$ , 80.0 $\Omega$	9.78 x 0.69	0.385 x 0.027
$l_8$	0.018 $\lambda$ , 8.5 $\Omega$	1.35 x 16.26	0.053 x 0.640
$l_9$	0.105 $\lambda$ , 8.5 $\Omega$	8.08 x 16.26	0.318 x 0.640
$l_{10}$	0.173 $\lambda$ , 67.0 $\Omega$	14.83 x 1.02	0.584 x 0.040
$l_{11}$	0.051 $\lambda$ , 41.0 $\Omega$	4.11 x 2.29	0.162 x 0.090
$l_{12}$	0.077 $\lambda$ , 41.0 $\Omega$	6.35 x 2.29	0.250 x 0.090
$l_{13}$	0.032 $\lambda$ , 50.0 $\Omega$	2.79 x 1.52	0.110 x 0.060

<sup>1</sup>Electrical characteristics are rounded.

Reference Circuit (cont.)

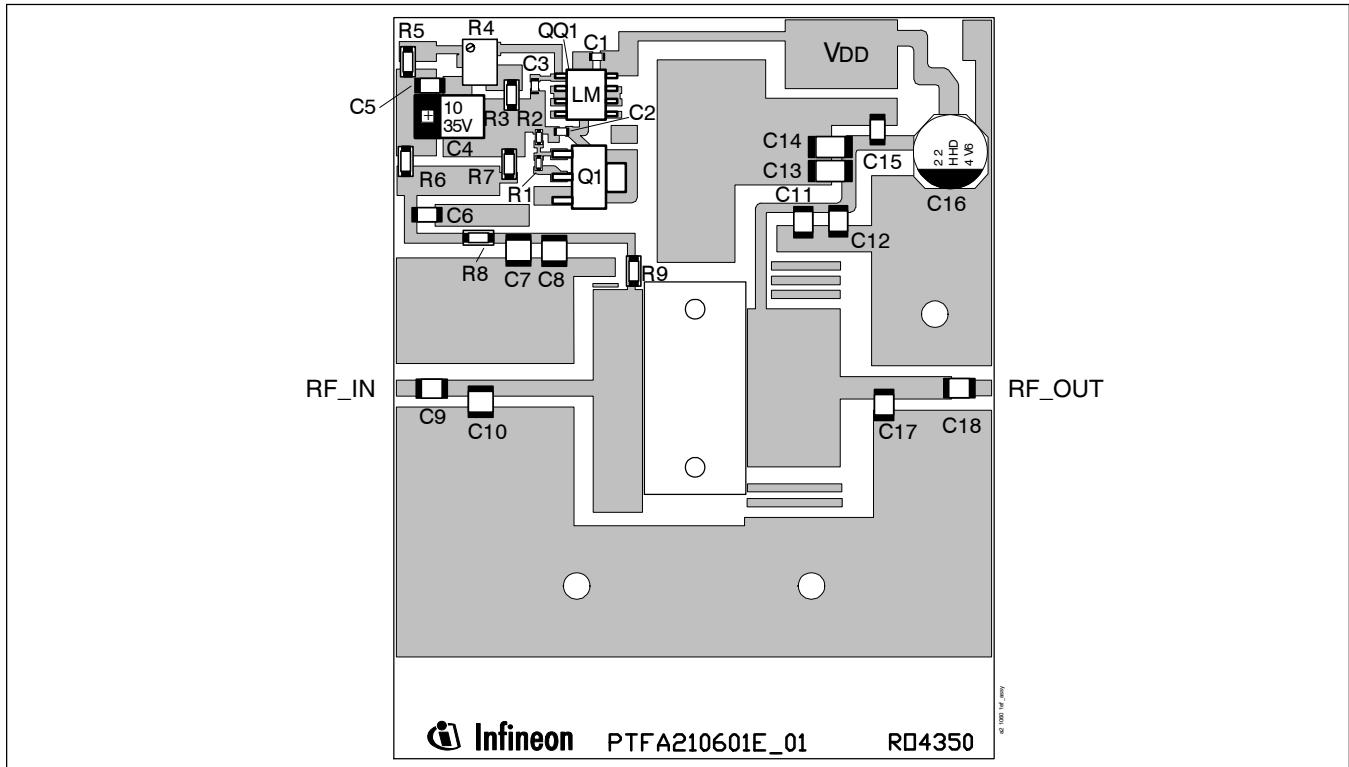

Reference circuit assembly diagram (not to scale)\*

Component	Description	Suggested Manufacturer	P/N or Comment
C1, C2, C3	Capacitor, 0.001 $\mu$ F	Digi-Key	PCC1772CT-ND
C4	Tantalum capacitor, 10 $\mu$ F, 35 V	Digi-Key	PCS6106TR-ND
C5, C6, C15	Capacitor, 0.1 $\mu$ F	Digi-Key	PCC104BCT-ND
C7	Capacitor, 0.01 $\mu$ F	ATC	100B 103
C8, C9, C11, C18	Ceramic capacitor, 10 pF	ATC	100B 100
C10	Ceramic capacitor, 1.5 pF	ATC	100B 1R5
C12	Capacitor, 0.02 $\mu$ F	ATC	200B 203
C13, C14	Capacitor, 1.0 $\mu$ F	Digi-Key	445-1411-1-ND
C16	Electrolytic capacitor, 22 $\mu$ F, 50 V	Digi-Key	PCE3374CT-ND
C17	Ceramic capacitor, 0.7 pF	ATC	100B 0R7
Q1	Transistor	Infineon Technologies	BCP56
QQ1	Voltage regulator	National Semiconductor	LM7805
R1	Chip resistor, 1.2k ohms	Digi-Key	P1.2KGCT-ND
R2	Chip resistor, 1.3k ohms	Digi-Key	P1.3KGCT-ND
R3	Chip resistor, 2k ohms	Digi-Key	P2KECT-ND
R4	Potentiometer, 2k ohms	Digi-Key	3224W-202ETR-ND
R5, R9	Chip resistor, 10 ohms	Digi-Key	P10ECT-ND
R6, R7, R8	Chip resistor, 1k ohms	Digi-Key	P1KECT-ND

\*Gerber Files for this circuit available on request





Package Outline Specifications (cont.)

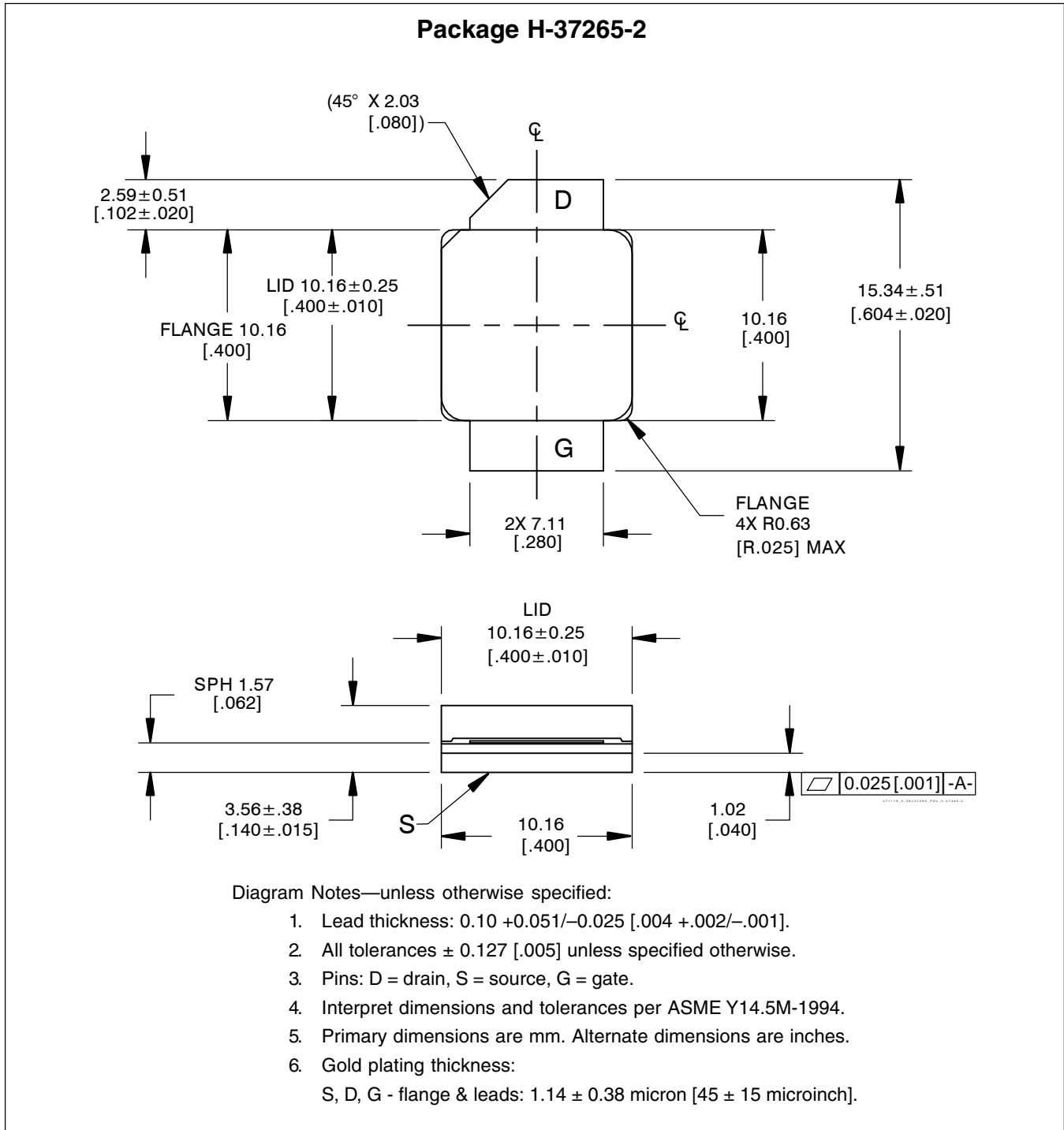

Find the latest and most complete information about products and packaging at the Infineon Internet page  
<http://www.infineon.com/products>

Revision History: 2007-11-19

Data Sheet

Previous Version: 2007-03-02, Data Sheet

Page	Subjects (major changes since last revision)
1, 2, 8, 9	Update to product V4, with new package technologies. Update package outline diagrams.

### We Listen to Your Comments

Any information within this document that you feel is wrong, unclear or missing at all?

Your feedback will help us to continuously improve the quality of this document.

Please send your proposal (including a reference to this document) to:

[highpowerRF@infineon.com](mailto:highpowerRF@infineon.com)

To request other information, contact us at:

+1 877 465 3667 (1-877-GO-LDMOS) USA

or +1 408 776 0600 International

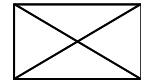

*GOLDMOS*<sup>®</sup> is a registered trademark of Infineon Technologies AG.

**Edition 2007-11-19**

**Published by**

**Infineon Technologies AG**

**81726 München, Germany**

**© Infineon Technologies AG 2005.**

**All Rights Reserved.**

### Legal Disclaimer

The information given in this document shall in no event be regarded as a guarantee of conditions or characteristics ("Beschaffheitsgarantie"). With respect to any examples or hints given herein, any typical values stated herein and/or any information regarding the application of the device, Infineon Technologies hereby disclaims any and all warranties and liabilities of any kind, including without limitation warranties of non-infringement of intellectual property rights of any third party.

### Information

For further information on technology, delivery terms and conditions and prices please contact your nearest Infineon Technologies Office ([www.infineon.com/rfpower](http://www.infineon.com/rfpower)).

### Warnings

Due to technical requirements components may contain dangerous substances. For information on the types in question please contact your nearest Infineon Technologies Office.

Infineon Technologies Components may only be used in life-support devices or systems with the express written approval of Infineon Technologies, if a failure of such components can reasonably be expected to cause the failure of that life-support device or system, or to affect the safety or effectiveness of that device or system. Life support devices or systems are intended to be implanted in the human body, or to support and/or maintain and sustain and/or protect human life. If they fail, it is reasonable to assume that the health of the user or other persons may be endangered.