

**RADIATION HARDENED  
 POWER MOSFET  
 SURFACE MOUNT (Low-Ohmic TO-254AA)**

**IRHMK597160  
 100V, P-CHANNEL  
 R5 TECHNOLOGY**

**Product Summary**

| Part Number | Radiation Level | RDS(on) | ID    |
|-------------|-----------------|---------|-------|
| IRHMK597160 | 100K Rads (Si)  | 0.05Ω   | -45A* |
| IRHMK593160 | 300K Rads (Si)  | 0.05Ω   | -45A* |



International Rectifier's R5™ technology provides high performance power MOSFETs for space applications. These devices have been characterized for Single Event Effects (SEE) with useful performance up to an LET of 80 (MeV/(mg/cm<sup>2</sup>)). The combination of low RDS(on) and low gate charge reduces the power losses in switching applications such as DC to DC converters and motor control. These devices retain all of the well established advantages of MOSFETs such as voltage control, fast switching, ease of paralleling and temperature stability of electrical parameters.

**Features:**

- Low RDS(on)
- Fast Switching
- Single Event Effect (SEE) Hardened
- Low Total Gate Charge
- Simple Drive Requirements
- Ease of Paralleling
- Hermetically Sealed
- Ceramic Eyelets
- Electrically Isolated
- Light Weight

**Absolute Maximum Ratings**

**Pre-Irradiation**

|                             | Parameter                       |               | Units |
|-----------------------------|---------------------------------|---------------|-------|
| ID @ VGS = -12V, TC = 25°C  | Continuous Drain Current        | -45*          | A     |
| ID @ VGS = -12V, TC = 100°C | Continuous Drain Current        | -30           |       |
| IDM                         | Pulsed Drain Current ①          | -180          |       |
| PD @ TC = 25°C              | Max. Power Dissipation          | 208           | W     |
|                             | Linear Derating Factor          | 1.67          | W/°C  |
| VGS                         | Gate-to-Source Voltage          | ±20           | V     |
| EAS                         | Single Pulse Avalanche Energy ② | 480           | mJ    |
| IAR                         | Avalanche Current ①             | -45           | A     |
| EAR                         | Repetitive Avalanche Energy ①   | 20.8          | mJ    |
| dv/dt                       | Peak Diode Recovery dv/dt ③     | -6.0          | V/ns  |
| TJ                          | Operating Junction              | -55 to 150    | °C    |
| TSTG                        | Storage Temperature Range       |               |       |
|                             | Pack. Mounting Surface Temp.    | 300 (for 5s)  |       |
|                             | Weight                          | 3.7 (Typical) | g     |

\* Current is limited by package

For footnotes refer to the last page

www.irf.com

**Electrical Characteristics @ T<sub>j</sub> = 25°C (Unless Otherwise Specified)**

|                                     | Parameter                                    | Min  | Typ   | Max  | Units | Test Conditions  |
|-------------------------------------|--|------|-------|------|-------|--|
| BV <sub>DSS</sub>                   | Drain-to-Source Breakdown Voltage            | -100 | —     | —    | V     | V <sub>GS</sub> = 0V, I <sub>D</sub> = -1.0mA  |
| ΔBV <sub>DSS</sub> /ΔT <sub>J</sub> | Temperature Coefficient of Breakdown Voltage | —    | -0.13 | —    | V/°C  | Reference to 25°C, I <sub>D</sub> = -1.0mA   |
| R <sub>DS(on)</sub>                 | Static Drain-to-Source On-State Resistance   | —    | —     | 0.05 | Ω     | V <sub>GS</sub> = -12V, I <sub>D</sub> = -30A ①  |
| V <sub>GS(th)</sub>                 | Gate Threshold Voltage                       | -2.0 | —     | -4.0 | V     | V <sub>DS</sub> = V <sub>GS</sub> , I <sub>D</sub> = -1.0mA  |
| g <sub>fs</sub>                     | Forward Transconductance                     | 24   | —     | —    | S (②) | V <sub>DS</sub> > -15V, I <sub>DS</sub> = -30A ①   |
| I <sub>DSS</sub>                    | Zero Gate Voltage Drain Current              | —    | —     | -10  | μA    | V <sub>DS</sub> = -80V, V <sub>GS</sub> = 0V   |
|                                     |  | —    | —     | -25  |       | V <sub>DS</sub> = -80V,<br>V <sub>GS</sub> = 0V, T <sub>J</sub> = 125°C  |
| I <sub>GSS</sub>                    | Gate-to-Source Leakage Forward               | —    | —     | -100 | nA    | V <sub>GS</sub> = -20V   |
| I <sub>GSS</sub>                    | Gate-to-Source Leakage Reverse               | —    | —     | 100  |       | V <sub>GS</sub> = 20V  |
| Q <sub>g</sub>                      | Total Gate Charge                            | —    | —     | 170  | nC    | V <sub>GS</sub> = -12V, I <sub>D</sub> = -45A<br>V <sub>DS</sub> = -50V  |
| Q <sub>gs</sub>                     | Gate-to-Source Charge                        | —    | —     | 65   |       |  |
| Q <sub>gd</sub>                     | Gate-to-Drain ('Miller') Charge              | —    | —     | 30   |       |  |
| t <sub>d(on)</sub>                  | Turn-On Delay Time                           | —    | —     | 35   | ns    | V <sub>DD</sub> = -50V, I <sub>D</sub> = -45A<br>V <sub>GS</sub> = -12V, R <sub>G</sub> = 1.2Ω   |
| t <sub>r</sub>                      | Rise Time                                    | —    | —     | 140  |       |  |
| t <sub>d(off)</sub>                 | Turn-Off Delay Time                          | —    | —     | 70   |       |  |
| t <sub>f</sub>                      | Fall Time                                    | —    | —     | 45   |       |  |
| L <sub>S</sub> + L <sub>D</sub>     | Total Inductance                             | —    | 6.8   | —    | nH    | Measured from Drain lead (6mm /0.25in. from package) to Source lead (6mm /0.25in. from package) with Source wires internally bonded from Source Pin to Drain Pad |
| C <sub>iss</sub>                    | Input Capacitance                            | —    | 6110  | —    | pF    | V <sub>GS</sub> = 0V, V <sub>DS</sub> = -25V<br>f = 1.0MHz   |
| C <sub>oss</sub>                    | Output Capacitance                           | —    | 1574  | —    |       |  |
| C <sub>rss</sub>                    | Reverse Transfer Capacitance                 | —    | 115   | —    |       |  |

**Source-Drain Diode Ratings and Characteristics**

|                 | Parameter                              | Min  | Typ | Max  | Units | Test Conditions  |
|-----------------|--|--|-----|------|-------|--|
| I <sub>S</sub>  | Continuous Source Current (Body Diode) | —  | —   | -45* | A     | T <sub>j</sub> = 25°C, I <sub>S</sub> = -45A, V <sub>GS</sub> = 0V ① |
| I <sub>SM</sub> | Pulse Source Current (Body Diode) ①    | —  | —   | -180 |       |  |
| V <sub>SD</sub> | Diode Forward Voltage                  | —  | —   | -5.0 | V     | T <sub>j</sub> = 25°C, I <sub>F</sub> = -45A, di/dt ≤ -100A/μs       |
| t <sub>rr</sub> | Reverse Recovery Time                  | —  | —   | 200  | ns    | V <sub>DD</sub> ≤ -25V ①   |
| Q <sub>RR</sub> | Reverse Recovery Charge                | —  | —   | 1.6  | μC    |  |
| t <sub>on</sub> | Forward Turn-On Time                   | Intrinsic turn-on time is negligible. Turn-on speed is substantially controlled by L <sub>S</sub> + L <sub>D</sub> . |     |      |       |  |

\* Current is limited by package

**Thermal Resistance**

|                   | Parameter           | Min | Typ  | Max | Units | Test Conditions      |
|-------------------|---------------------|-----|------|-----|-------|----------------------|
| R <sub>thJC</sub> | Junction-to-Case    | —   | —    | 0.6 | °C/W  | Typical socket mount |
| R <sub>thCS</sub> | Case-to-Sink        | —   | 0.21 | —   |       |                      |
| R <sub>thJA</sub> | Junction-to-Ambient | —   | —    | 48  |       |                      |

**Note: Corresponding Spice and Saber models are available on International Rectifier Website.**

For footnotes refer to the last page

## Radiation Characteristics

IRHMK597160

International Rectifier Radiation Hardened MOSFETs are tested to verify their radiation hardness capability. The hardness assurance program at International Rectifier is comprised of two radiation environments. Every manufacturing lot is tested for total ionizing dose (per notes 5 and 6) using the TO-3 package. Both pre- and post-irradiation performance are tested and specified using the same drive circuitry and test conditions in order to provide a direct comparison.

**Table 1. Electrical Characteristics @ Tj = 25°C, Post Total Dose Irradiation** ⑤⑥

|                     | Parameter   | 100K Rads(Si) <sup>1</sup> |      | 300KRads(Si) <sup>2</sup> |      | Units | Test Conditions   |
|---------------------|---|----------------------------|------|---------------------------|------|-------|---|
|                     |   | Min                        | Max  | Min                       | Max  |       |   |
| BV <sub>DSS</sub>   | Drain-to-Source Breakdown Voltage                               | -100                       | —    | -100                      | —    | V     | V <sub>GS</sub> = 0V, I <sub>D</sub> = -1.0mA               |
| V <sub>GS(th)</sub> | Gate Threshold Voltage  | -2.0                       | -4.0 | -2.0                      | -5.0 |       | V <sub>GS</sub> = V <sub>DS</sub> , I <sub>D</sub> = -1.0mA |
| I <sub>GS</sub>     | Gate-to-Source Leakage Forward                                  | —                          | -100 | —                         | -100 | nA    | V <sub>GS</sub> = -20V                                      |
| I <sub>GS</sub>     | Gate-to-Source Leakage Reverse                                  | —                          | 100  | —                         | 100  |       | V <sub>GS</sub> = 20 V                                      |
| I <sub>DSS</sub>    | Zero Gate Voltage Drain Current                                 | —                          | -10  | —                         | -10  | μA    | V <sub>DS</sub> = -80V, V <sub>GS</sub> = 0V                |
| R <sub>DS(on)</sub> | Static Drain-to-Source On-State Resistance (TO-3)               | —                          | 0.05 | —                         | 0.05 | Ω     | V <sub>GS</sub> = -12V, I <sub>D</sub> = -30A               |
| R <sub>DS(on)</sub> | Static Drain-to-Source On-State Resistance (Low-Ohmic TO-254AA) | —                          | 0.05 | —                         | 0.05 | Ω     | V <sub>GS</sub> = -12V, I <sub>D</sub> = -30A               |
| V <sub>SD</sub>     | Diode Forward Voltage   | —                          | -5.0 | —                         | -5.0 | V     | V <sub>GS</sub> = 0V, I <sub>S</sub> = -45A                 |

1. Part number IRHMK597160
2. Part number IRHMK593160

International Rectifier radiation hardened MOSFETs have been characterized in heavy ion environment for Single Event Effects (SEE). Single Event Effects characterization is illustrated in Fig. a and Table 2.

**Table 2. Single Event Effect Safe Operating Area**

| Ion | LET (MeV/(mg/cm <sup>2</sup> )) | Energy (MeV) | Range (μm) | V <sub>DS</sub> (V)  |                      |                       |                       |                         |                       |
|-----|---------------------------------|--------------|------------|----------------------|----------------------|-----------------------|-----------------------|-------------------------|-----------------------|
|     |                                 |              |            | @V <sub>GS</sub> =0V | @V <sub>GS</sub> =5V | @V <sub>GS</sub> =10V | @V <sub>GS</sub> =15V | @V <sub>GS</sub> =17.5V | @V <sub>GS</sub> =20V |
| Br  | 37.9                            | 252.6        | 33.1       | -100                 | -100                 | -100                  | -100                  | -100                    | -100                  |
| I   | 59.7                            | 314          | 30.5       | -100                 | -100                 | -100                  | -100                  | -75                     | -25                   |
| Au  | 82.3                            | 350          | 28.4       | -100                 | -100                 | -100                  | -30                   | —                       | —                     |

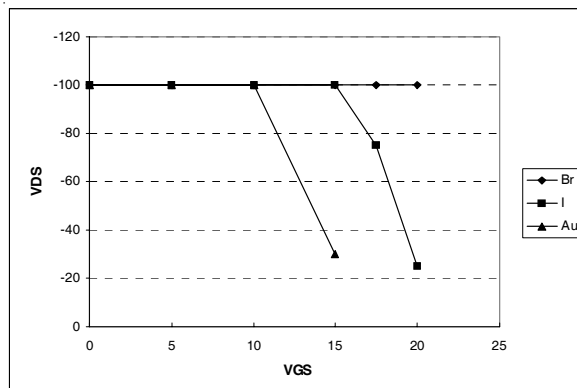

**Fig a. Single Event Effect, Safe Operating Area**

For footnotes refer to the last page

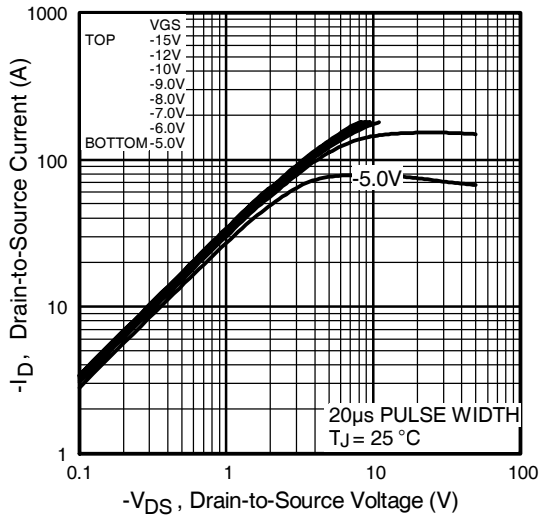

Fig 1. Typical Output Characteristics

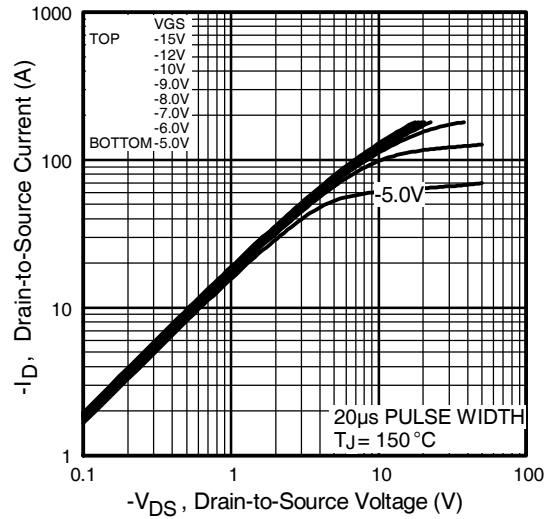

Fig 2. Typical Output Characteristics

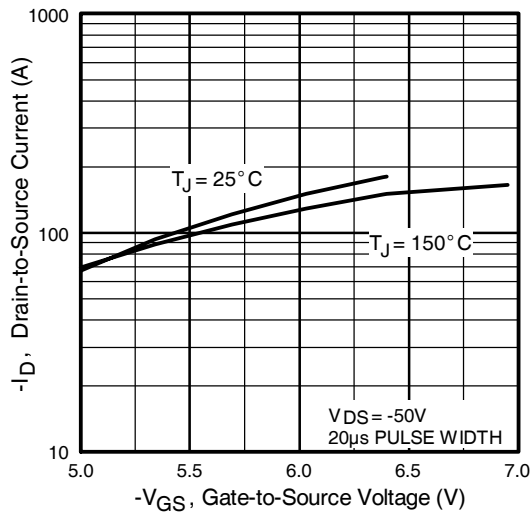

Fig 3. Typical Transfer Characteristics

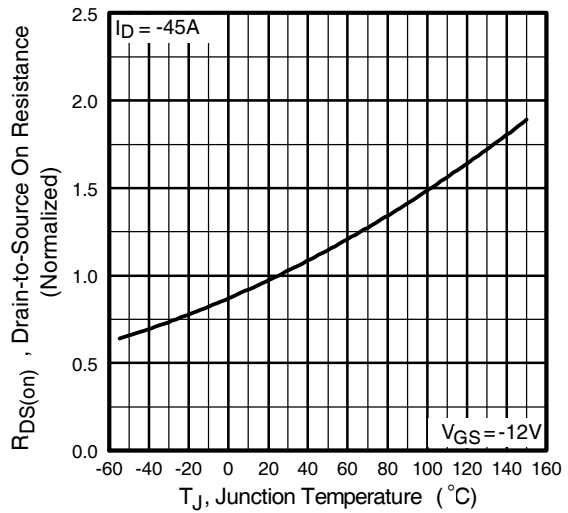
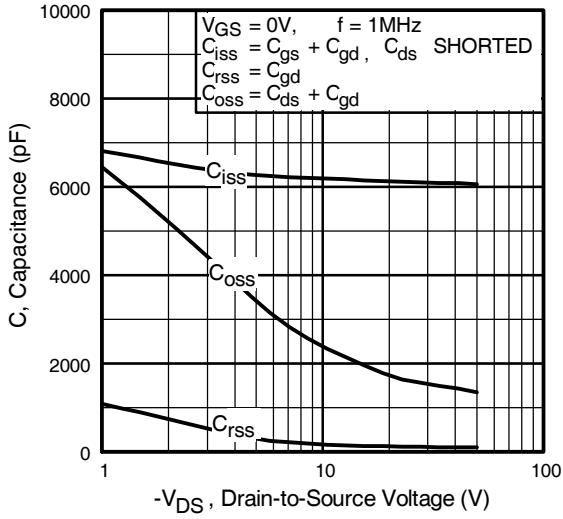
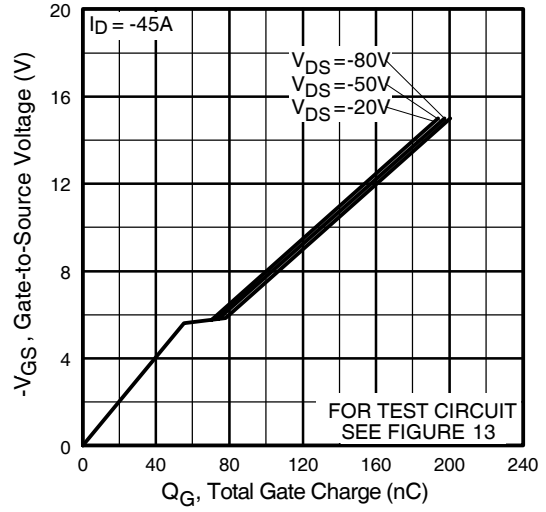

Fig 4. Normalized On-Resistance Vs. Temperature



**Fig 5.** Typical Capacitance Vs. Drain-to-Source Voltage



**Fig 6.** Typical Gate Charge Vs. Gate-to-Source Voltage

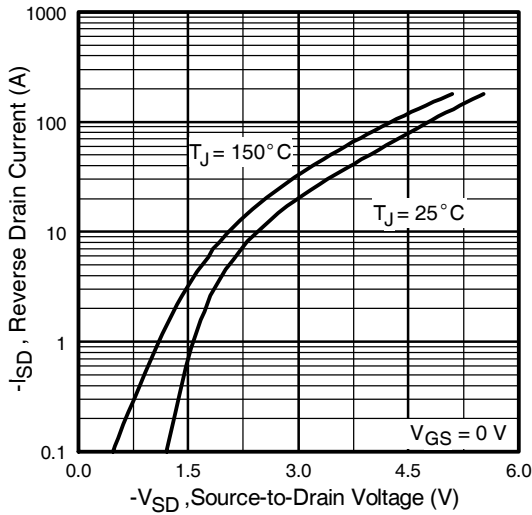

**Fig 7.** Typical Source-Drain Diode Forward Voltage

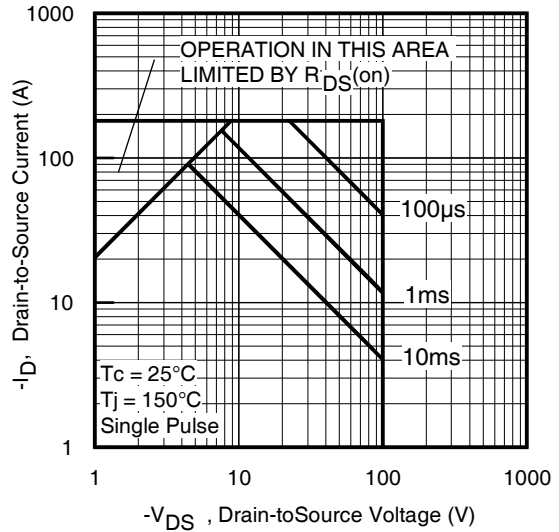

**Fig 8.** Maximum Safe Operating Area

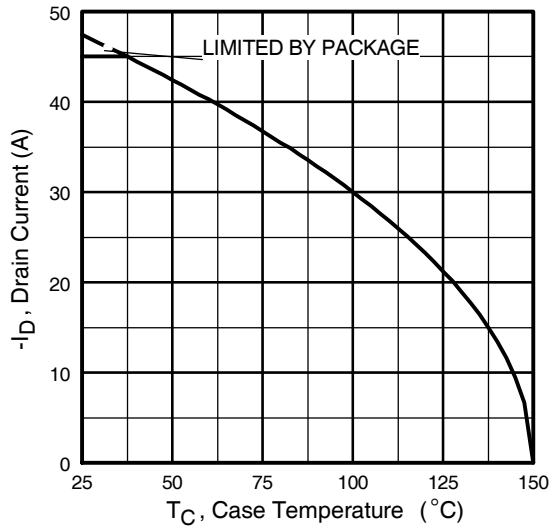

Fig 9. Maximum Drain Current Vs. Case Temperature

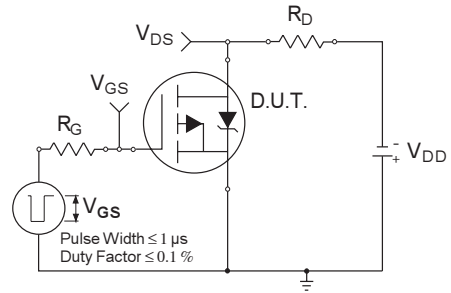

Fig 10a. Switching Time Test Circuit

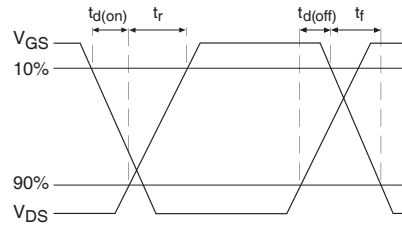

Fig 10b. Switching Time Waveforms

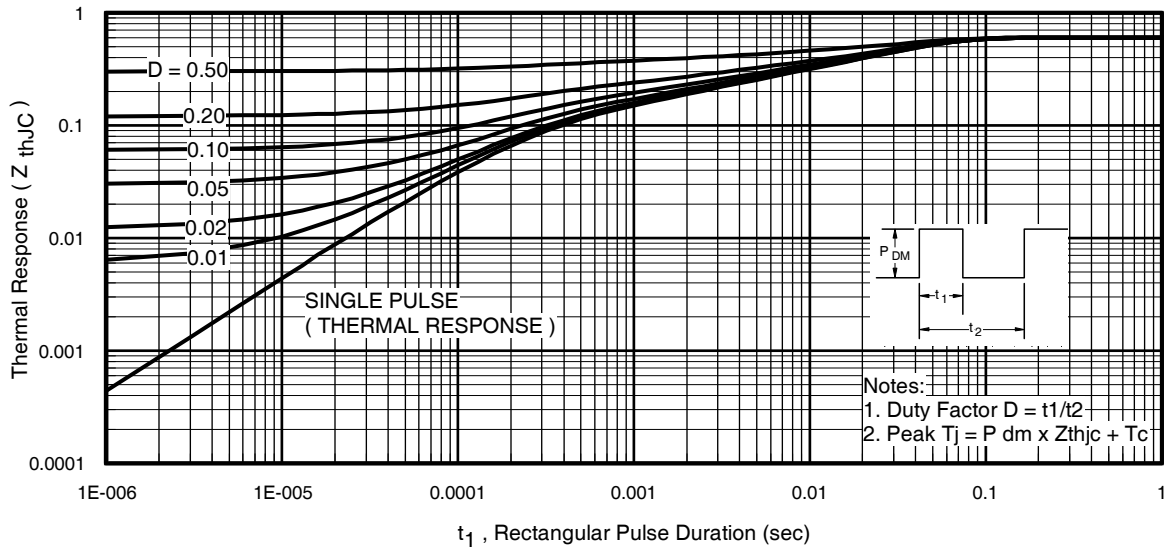

Fig 11. Maximum Effective Transient Thermal Impedance, Junction-to-Case

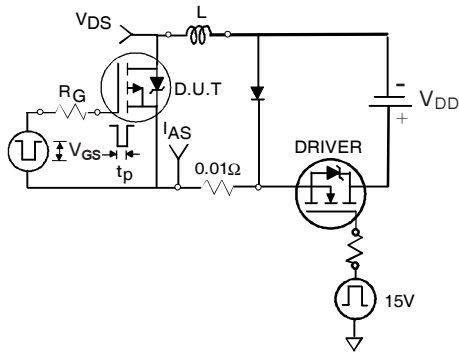

Fig 12a. Unclamped Inductive Test Circuit

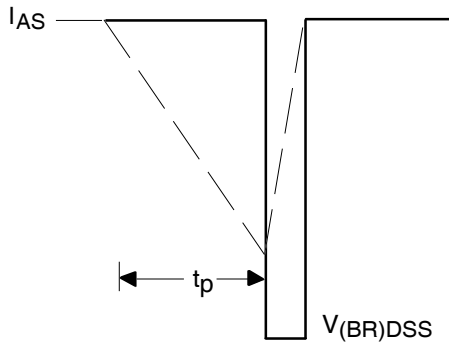

Fig 12b. Unclamped Inductive Waveforms

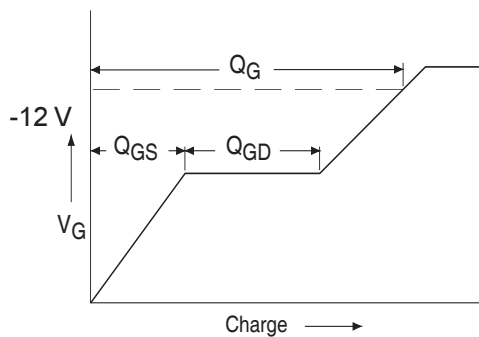

Fig 13a. Basic Gate Charge Waveform

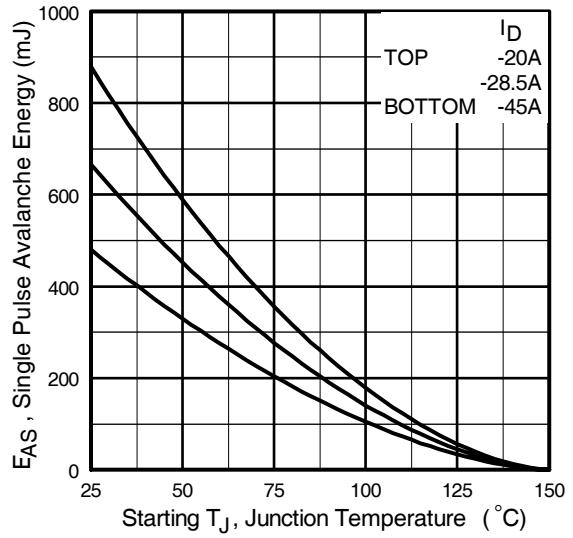

Fig 12c. Maximum Avalanche Energy Vs. Drain Current

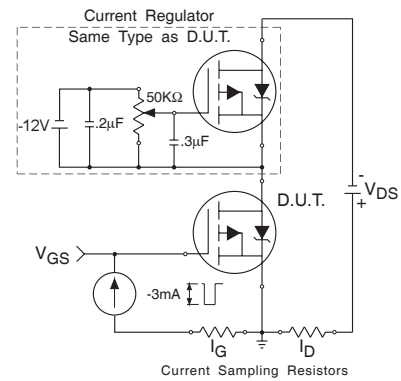
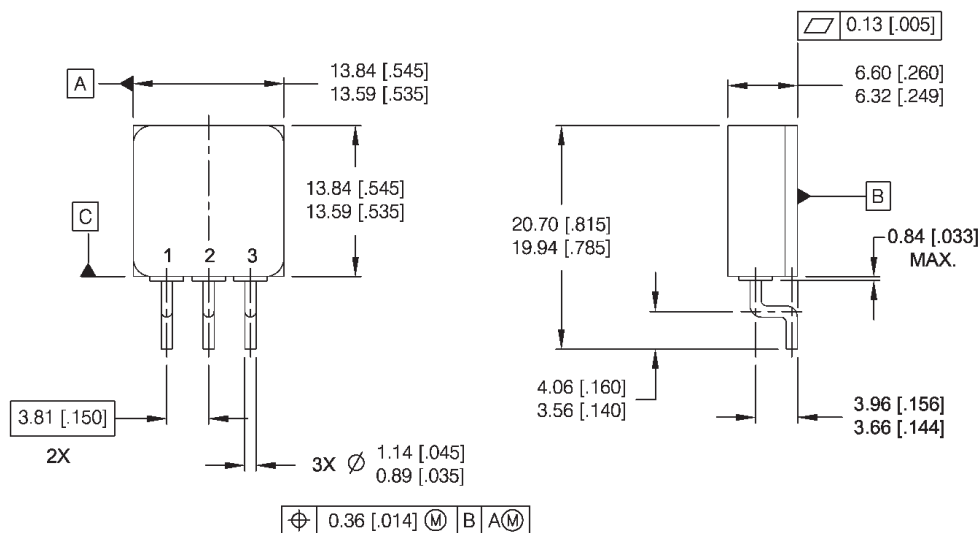

Fig 13b. Gate Charge Test Circuit

**Footnotes:**

- ① Repetitive Rating; Pulse width limited by maximum junction temperature.
- ②  $V_{DD} = -25V$ , starting  $T_J = 25^\circ C$ ,  $L = 0.48\text{ mH}$   
Peak  $I_L = -45A$ ,  $V_{GS} = -12V$
- ③  $I_{SD} \leq -45A$ ,  $di/dt \leq -365A/\mu s$ ,  
 $V_{DD} \leq -100V$ ,  $T_J \leq 150^\circ C$
- ④ Pulse width  $\leq 300\ \mu s$ ; Duty Cycle  $\leq 2\%$
- ⑤ **Total Dose Irradiation with  $V_{GS}$  Bias.**  
-12 volt  $V_{GS}$  applied and  $V_{DS} = 0$  during irradiation per MIL-STD-750, method 1019, condition A.
- ⑥ **Total Dose Irradiation with  $V_{DS}$  Bias.**  
-80 volt  $V_{DS}$  applied and  $V_{GS} = 0$  during irradiation per MIL-STD-750, method 1019, condition A.

**Case Outline and Dimensions — Low-Ohmic TO-254AA Tabless**



**NOTES:**

1. DIMENSIONING & TOLERANCING PER ASME Y14.5M-1994.
2. ALL DIMENSIONS ARE SHOWN IN MILLIMETERS (INCHES).
3. CONTROLLING DIMENSION: INCH.
4. THIS OUTLINE IS A MODIFIED TO-254AA JEDEC OUTLINE.

**PIN ASSIGNMENTS**

- 1 = DRAIN
- 2 = SOURCE
- 3 = GATE

**CAUTION**

**BERYLLIA WARNING PER MIL-PRF-19500**

Packages containing beryllia shall not be ground, sandblasted, machined, or have other operations performed on them which will produce beryllia or beryllium dust. Furthermore, beryllium oxide packages shall not be placed in acids that will produce fumes containing beryllium.

International  
**IR** Rectifier

**IR WORLD HEADQUARTERS:** 233 Kansas St., El Segundo, California 90245, USA Tel: (310) 252-7105

**IR LEOMINSTER :** 205 Crawford St., Leominster, Massachusetts 01453, USA Tel: (978) 534-5776

TAC Fax: (310) 252-7903

Visit us at [www.irf.com](http://www.irf.com) for sales contact information.

Data and specifications subject to change without notice. 12/2006