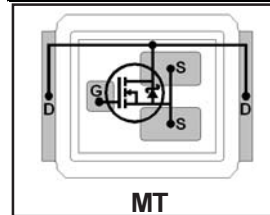


# IRF6603

HEXFET® Power MOSFET

- Application Specific MOSFETs
- Ideal for CPU Core DC-DC Converters
- Low Conduction Losses
- High Cdv/dt Immunity
- Low Profile (<0.7 mm)
- Dual Sided Cooling Compatible
- Compatible with existing Surface Mount Techniques

$V_{DS}$	$R_{DS(on)}$ max	$Q_g$ (typ.)
30V	3.4mΩ @ $V_{GS} = 10V$	48nC
	5.5mΩ @ $V_{GS} = 4.5V$	



Applicable DirectFET Outline and Substrate Outline (see p.9,10 for details)

SQ	SX	ST		MQ	MX	MT			
----	----	----	--	----	----	----	--	--	--

## Description

The IRF6603 combines the latest HEXFET® Power MOSFET Silicon technology with the advanced DirectFET™ packaging to achieve the lowest on-state resistance in a package that has the footprint of an SO-8 and only 0.7 mm profile. The DirectFET package is compatible with existing layout geometries used in power applications, PCB assembly equipment and vapor phase, infra-red or convection soldering techniques, when application note AN-1035 is followed regarding the manufacturing methods and process. The DirectFET package allows dual sided cooling to maximize thermal transfer in power systems, IMPROVING previous best thermal resistance by 80%.

The IRF6603 balances both low resistance and low charge along with ultra low package inductance to reduce both conduction and switching losses. The reduced total losses make this product ideal for high efficiency DC-DC converters that power the latest generation of processors operating at higher frequencies. The IRF6603 has been optimized for parameters that are critical in synchronous buck converters including  $R_{ds(on)}$ , gate charge and Cdv/dt-induced turn on immunity. The IRF6603 offers particularly low  $R_{ds(on)}$  and high Cdv/dt immunity for synchronous FET applications.

## Absolute Maximum Ratings

	Parameter	Max.	Units
$V_{DS}$	Drain-to-Source Voltage	30	V
$V_{GS}$	Gate-to-Source Voltage	+20/-12	
$I_D @ T_A = 25^\circ C$	Continuous Drain Current, $V_{GS} @ 10V$ ④	27	A
$I_D @ T_A = 70^\circ C$	Continuous Drain Current, $V_{GS} @ 10V$ ④	22	
$I_D @ T_C = 25^\circ C$	Continuous Drain Current, $V_{GS} @ 10V$ ⑦	92	
$I_{DM}$	Pulsed Drain Current ①	200	
$P_D @ T_A = 25^\circ C$	Power Dissipation ④	3.6	W
$P_D @ T_A = 70^\circ C$	Power Dissipation ④	2.3	
$P_D @ T_C = 25^\circ C$	Power Dissipation ⑦	42	
	Linear Derating Factor	0.029	W/°C
$T_J$	Operating Junction and	-40 to + 150	°C
$T_{STG}$	Storage Temperature Range		

## Thermal Resistance

	Parameter	Typ.	Max.	Units
$R_{\theta JA}$	Junction-to-Ambient ④ ⑧	—	35	°C/W
$R_{\theta JA}$	Junction-to-Ambient ⑤ ⑧	12.5	—	
$R_{\theta JA}$	Junction-to-Ambient ⑥ ⑧	20	—	
$R_{\theta JC}$	Junction-to-Case ⑦ ⑧	—	3.0	
$R_{\theta J-PCB}$	Junction-to-PCB Mounted	1.0	—	

Notes ① through ⑧ are on page 11

www.irf.com

# IRF6603

Static @  $T_J = 25^\circ\text{C}$  (unless otherwise specified)

International  
IR Rectifier

	Parameter	Min.	Typ.	Max.	Units	Conditions
$BV_{DSS}$	Drain-to-Source Breakdown Voltage	30	—	—	V	$V_{GS} = 0V, I_D = 250\mu A$
$\Delta BV_{DSS}/\Delta T_J$	Breakdown Voltage Temp. Coefficient	—	28	—	mV/°C	Reference to $25^\circ\text{C}, I_D = 1\text{mA}$
$R_{DS(on)}$	Static Drain-to-Source On-Resistance	—	2.4	3.4	m $\Omega$	$V_{GS} = 10V, I_D = 25A$ ③
		—	3.9	5.5		$V_{GS} = 4.5V, I_D = 20A$ ③
$V_{GS(th)}$	Gate Threshold Voltage	1.4	—	2.5	V	$V_{DS} = V_{GS}, I_D = 250\mu A$
$\Delta V_{GS(th)}/\Delta T_J$	Gate Threshold Voltage Coefficient	—	-6.3	—	mV/°C	
$I_{DSS}$	Drain-to-Source Leakage Current	—	—	30	$\mu A$	$V_{DS} = 24V, V_{GS} = 0V$
		—	—	50	$\mu A$	$V_{DS} = 30V, V_{GS} = 0V$
		—	—	100	$\mu A$	$V_{DS} = 24V, V_{GS} = 0V, T_J = 70^\circ\text{C}$
$I_{GSS}$	Gate-to-Source Forward Leakage	—	—	100	nA	$V_{GS} = 20V$
	Gate-to-Source Reverse Leakage	—	—	-100	nA	$V_{GS} = -12V$
$g_{fs}$	Forward Transconductance	56	—	—	S	$V_{DS} = 15V, I_D = 20A$
$Q_g$	Total Gate Charge	—	48	72	nC	$V_{DS} = 15V$ $V_{GS} = 4.5V$ $I_D = 20A$ See Fig. 16
$Q_{gs1}$	Pre-Vth Gate-to-Source Charge	—	15.6	—		
$Q_{gs2}$	Post-Vth Gate-to-Source Charge	—	5.2	—		
$Q_{gd}$	Gate-to-Drain Charge	—	16.1	—		
$Q_{godr}$	Gate Charge Overdrive	—	11.1	—		
$Q_{sw}$	Switch Charge ( $Q_{gs2} + Q_{gd}$ )	—	21.3	—		
$Q_{oss}$	Output Charge	—	28	—	nC	$V_{DS} = 16V, V_{GS} = 0V$
$R_G$	Gate Resistance	—	1.0	2.0	$\Omega$	
$t_{d(on)}$	Turn-On Delay Time	—	20	—	ns	$V_{DD} = 15V, V_{GS} = 4.5V$ ③ $I_D = 20A$ Clamped Inductive Load
$t_r$	Rise Time	—	9.9	—		
$t_{d(off)}$	Turn-Off Delay Time	—	24	—		
$t_f$	Fall Time	—	71	—		
$C_{iss}$	Input Capacitance	—	6590	—	pF	$V_{GS} = 0V$ $V_{DS} = 15V$ $f = 1.0\text{MHz}$
$C_{oss}$	Output Capacitance	—	1250	—		
$C_{rss}$	Reverse Transfer Capacitance	—	520	—		

## Avalanche Characteristics

	Parameter	Typ.	Max.	Units
$E_{AS}$	Single Pulse Avalanche Energy ②	—	49	mJ
$I_{AR}$	Avalanche Current ①	—	20	A
$E_{AR}$	Repetitive Avalanche Energy ①	—	4.1	mJ

## Diode Characteristics

	Parameter	Min.	Typ.	Max.	Units	Conditions
$I_S$	Continuous Source Current (Body Diode)	—	—	38	A	MOSFET symbol showing the integral reverse p-n junction diode.
$I_{SM}$	Pulsed Source Current (Body Diode) ①	—	—	200		
$V_{SD}$	Diode Forward Voltage	—	1.0	1.3	V	$T_J = 25^\circ\text{C}, I_S = 20A, V_{GS} = 0V$ ③
$t_{rr}$	Reverse Recovery Time	—	45	68	ns	$T_J = 25^\circ\text{C}, I_F = 20A$
$Q_{rr}$	Reverse Recovery Charge	—	60	90	nC	$di/dt = 100A/\mu s$ ③

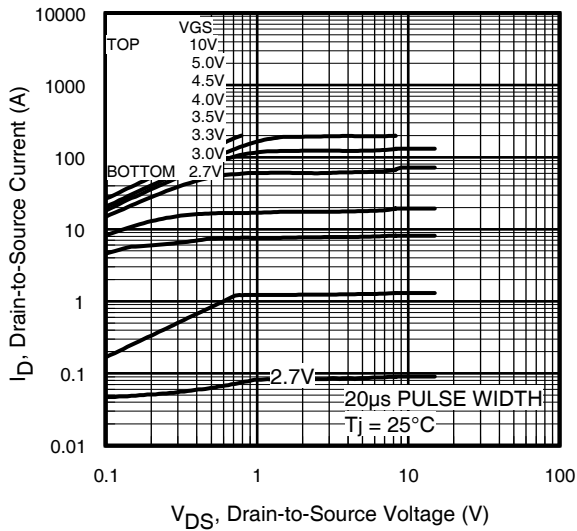


Fig 1. Typical Output Characteristics

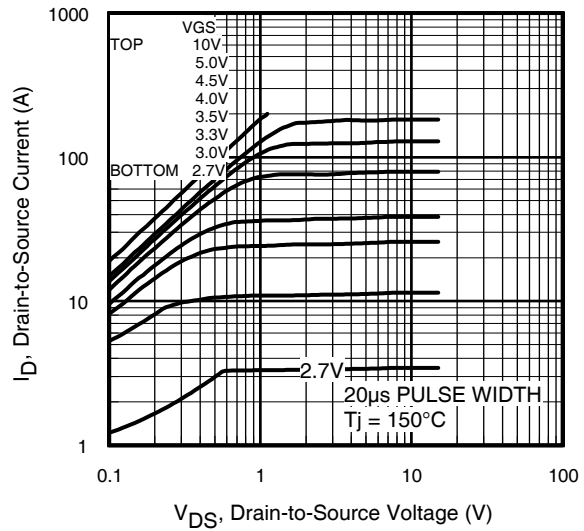


Fig 2. Typical Output Characteristics

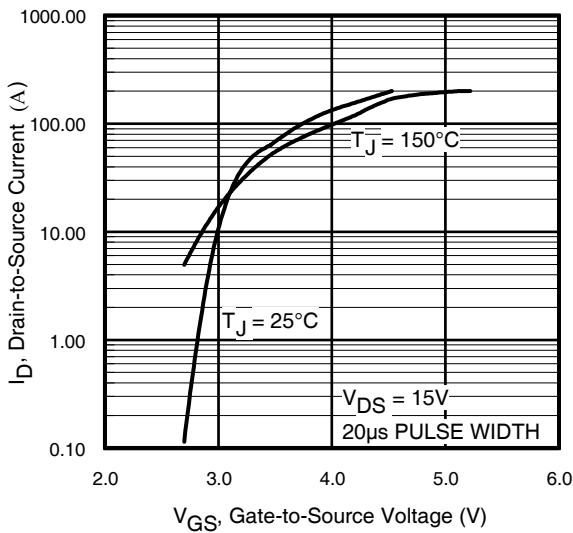


Fig 3. Typical Transfer Characteristics

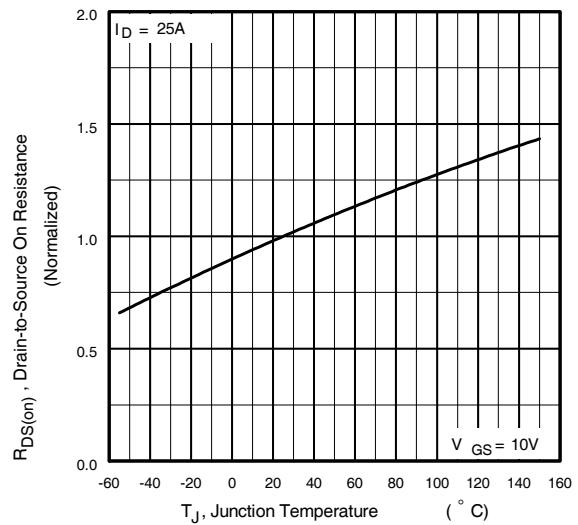
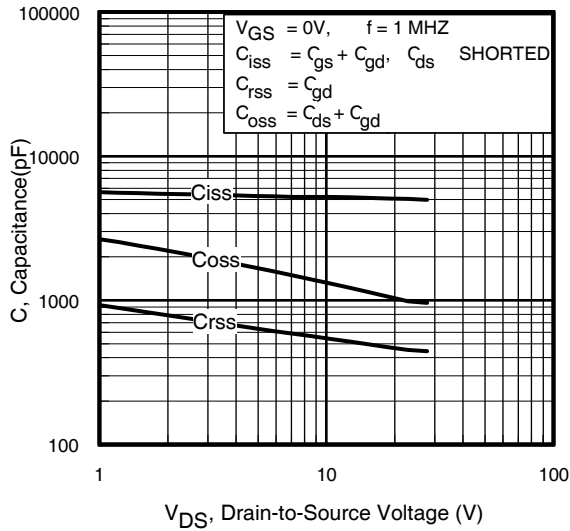


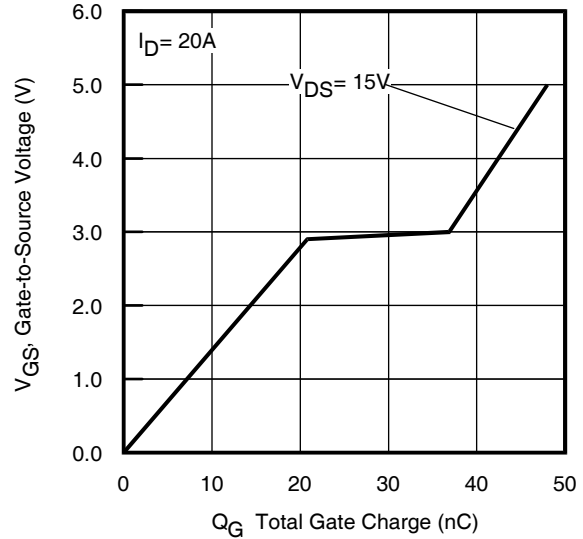
Fig 4. Normalized On-Resistance vs. Temperature

# IRF6603

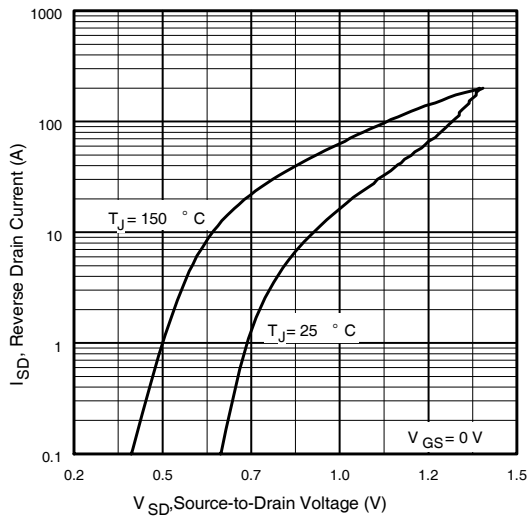
International  
**IR** Rectifier



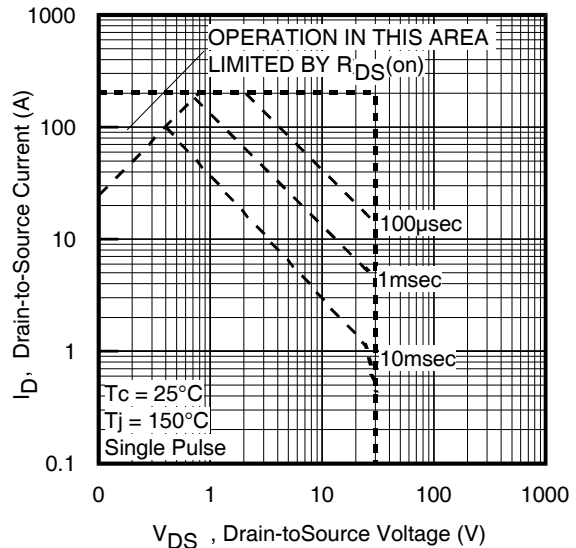
**Fig 5.** Typical Capacitance Vs. Drain-to-Source Voltage



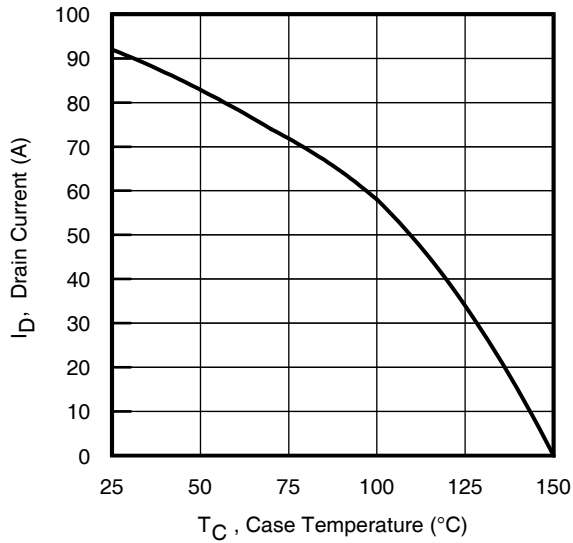
**Fig 6.** Typical Gate Charge Vs. Gate-to-Source Voltage



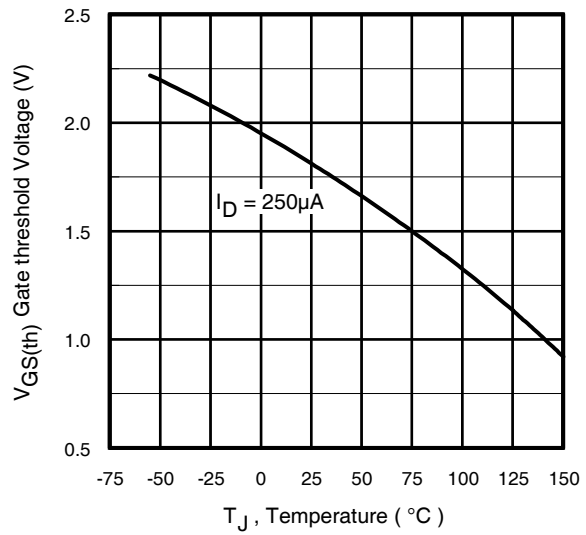
**Fig 7.** Typical Source-Drain Diode Forward Voltage



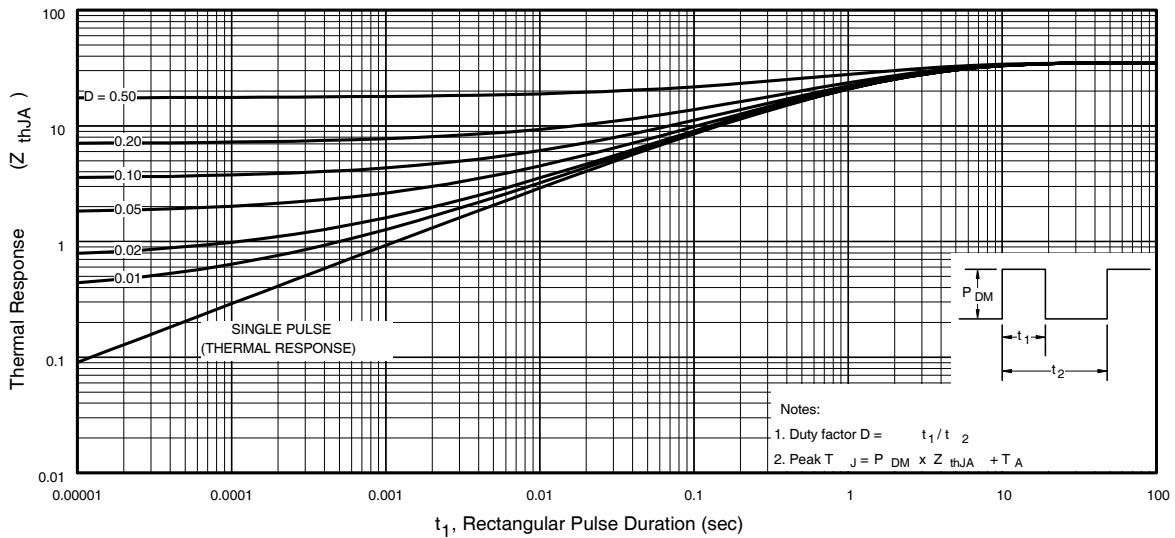
**Fig 8.** Maximum Safe Operating Area



**Fig 9.** Maximum Drain Current Vs. Case Temperature



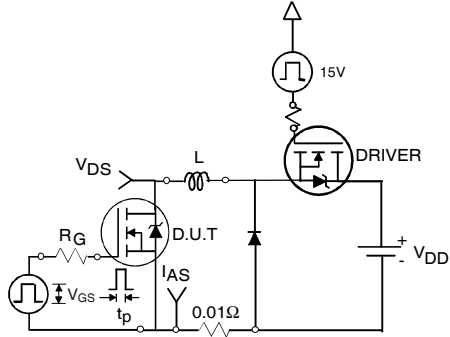
**Fig 10.** Threshold Voltage Vs. Temperature



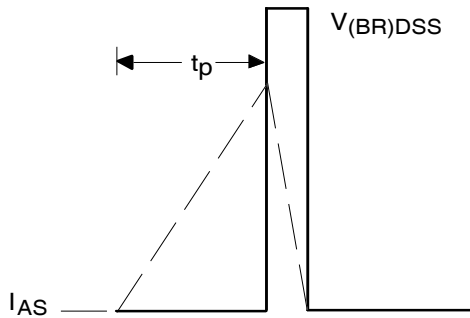
**Fig 11.** Maximum Effective Transient Thermal Impedance, Junction-to-Ambient

# IRF6603

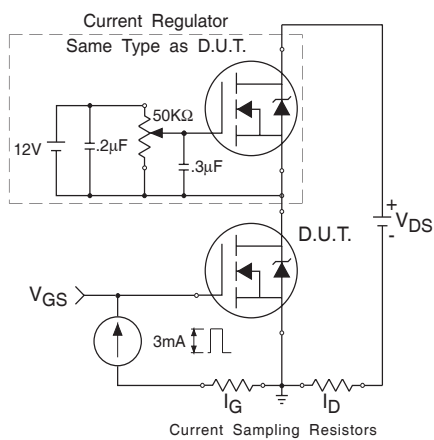
International  
**IR** Rectifier



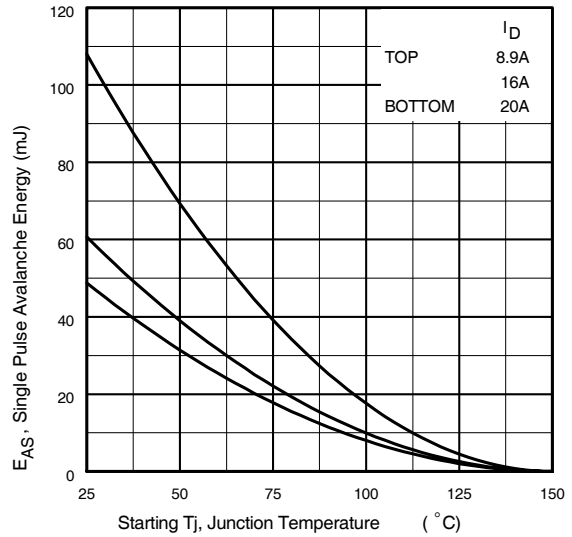
**Fig 12a.** Unclamped Inductive Test Circuit



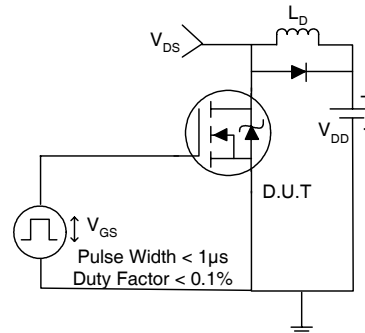
**Fig 12b.** Unclamped Inductive Waveforms



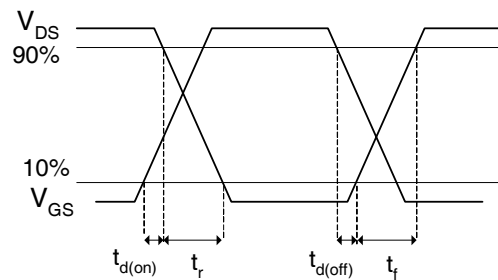
**Fig 13.** Gate Charge Test Circuit



**Fig 12c.** Maximum Avalanche Energy Vs. Drain Current

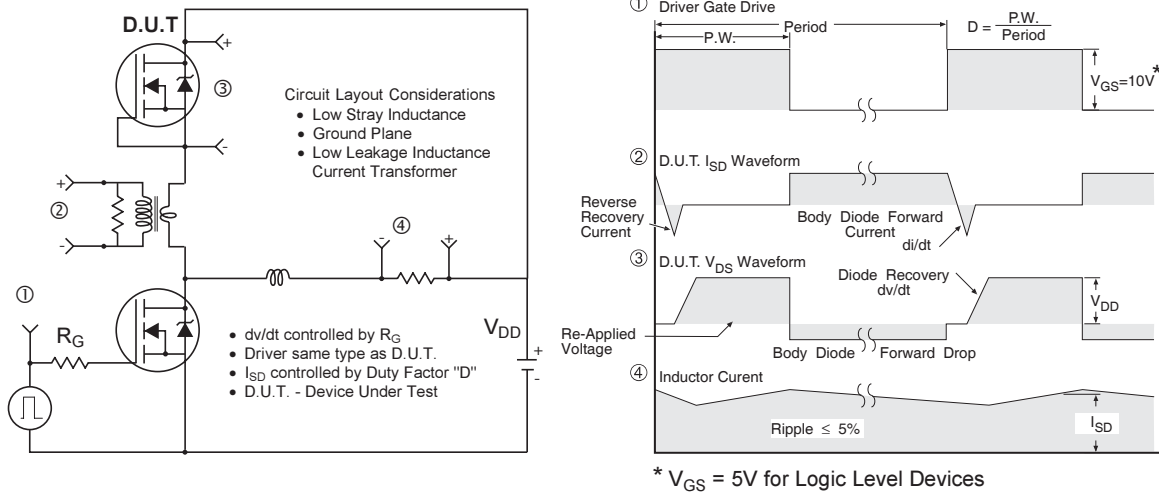


**Fig 14a.** Switching Time Test Circuit

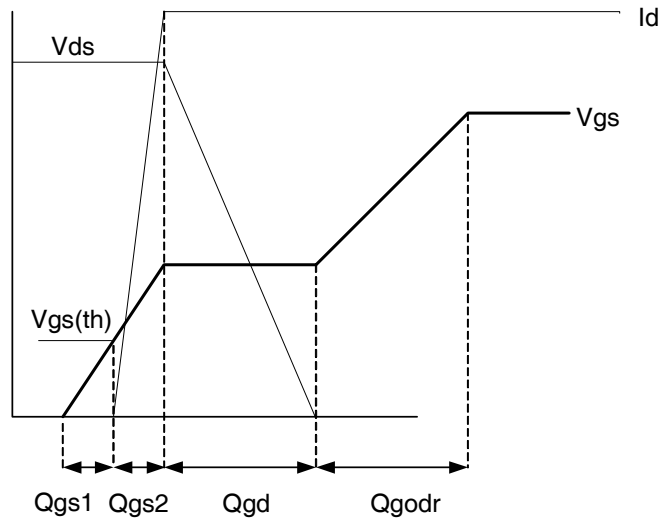


**Fig 14b.** Switching Time Waveforms

www.irf.com



**Fig 15. Peak Diode Recovery  $dv/dt$  Test Circuit for N-Channel HEXFET® Power MOSFETs**



**Fig 16. Gate Charge Waveform**

## Power MOSFET Selection for Non-Isolated DC/DC Converters

### Control FET

Special attention has been given to the power losses in the switching elements of the circuit - Q1 and Q2. Power losses in the high side switch Q1, also called the Control FET, are impacted by the  $R_{ds(on)}$  of the MOSFET, but these conduction losses are only about one half of the total losses.

Power losses in the control switch Q1 are given by;

$$P_{loss} = P_{conduction} + P_{switching} + P_{drive} + P_{output}$$

This can be expanded and approximated by;

$$P_{loss} = (I_{rms}^2 \times R_{ds(on)}) + \left( I \times \frac{Q_{gd}}{i_g} \times V_{in} \times f \right) + \left( I \times \frac{Q_{gs2}}{i_g} \times V_{in} \times f \right) + (Q_g \times V_g \times f) + \left( \frac{Q_{oss}}{2} \times V_{in} \times f \right)$$

This simplified loss equation includes the terms  $Q_{gs2}$  and  $Q_{oss}$  which are new to Power MOSFET data sheets.

$Q_{gs2}$  is a sub element of traditional gate-source charge that is included in all MOSFET data sheets. The importance of splitting this gate-source charge into two sub elements,  $Q_{gs1}$  and  $Q_{gs2}$ , can be seen from Fig 16.

$Q_{gs2}$  indicates the charge that must be supplied by the gate driver between the time that the threshold voltage has been reached and the time the drain current rises to  $I_{dmax}$  at which time the drain voltage begins to change. Minimizing  $Q_{gs2}$  is a critical factor in reducing switching losses in Q1.

$Q_{oss}$  is the charge that must be supplied to the output capacitance of the MOSFET during every switching cycle. Figure A shows how  $Q_{oss}$  is formed by the parallel combination of the voltage dependant (non-linear) capacitance's  $C_{ds}$  and  $C_{dg}$  when multiplied by the power supply input buss voltage.

### Synchronous FET

The power loss equation for Q2 is approximated by;

$$P_{loss} = P_{conduction} + P_{drive} + P_{output}^*$$

$$P_{loss} = (I_{rms}^2 \times R_{ds(on)}) + (Q_g \times V_g \times f) + \left( \frac{Q_{oss}}{2} \times V_{in} \times f \right) + (Q_{rr} \times V_{in} \times f)$$

\*dissipated primarily in Q1.

For the synchronous MOSFET Q2,  $R_{ds(on)}$  is an important characteristic; however, once again the importance of gate charge must not be overlooked since it impacts three critical areas. Under light load the MOSFET must still be turned on and off by the control IC so the gate drive losses become much more significant. Secondly, the output charge  $Q_{oss}$  and reverse recovery charge  $Q_{rr}$  both generate losses that are transferred to Q1 and increase the dissipation in that device. Thirdly, gate charge will impact the MOSFETs' susceptibility to Cdv/dt turn on.

The drain of Q2 is connected to the switching node of the converter and therefore sees transitions between ground and  $V_{in}$ . As Q1 turns on and off there is a rate of change of drain voltage dV/dt which is capacitively coupled to the gate of Q2 and can induce a voltage spike on the gate that is sufficient to turn the MOSFET on, resulting in shoot-through current. The ratio of  $Q_{gd}/Q_{gs1}$  must be minimized to reduce the potential for Cdv/dt turn on.

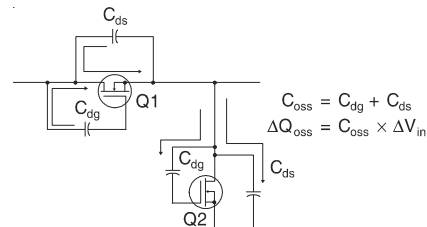
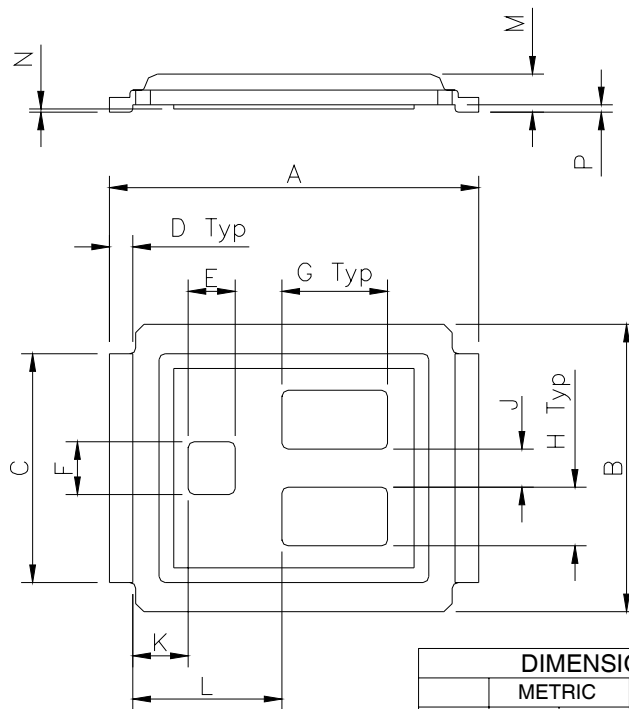


Figure A:  $Q_{oss}$  Characteristic



## DirectFET™ Outline Dimension, MT Outline (Medium Size Can, T-Designation).

Please see DirectFET application note AN-1035 for all details regarding the assembly of DirectFET. This includes all recommendations for stencil and substrate designs.



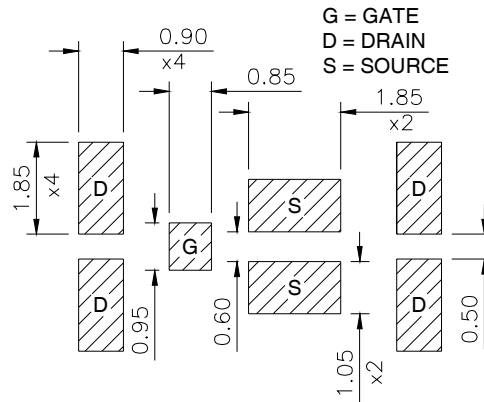
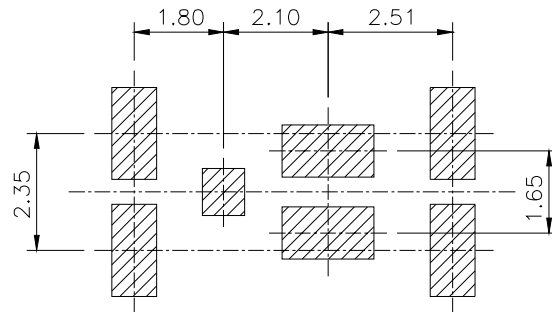
CODE	METRIC		IMPERIAL	
	MIN	MAX	MIN	MAX
A	6.25	6.35	0.246	0.250
B	4.80	5.05	0.189	0.199
C	3.85	3.95	0.152	0.156
D	0.35	0.45	0.014	0.018
E	0.78	0.82	0.031	0.032
F	0.88	0.92	0.035	0.036
G	1.78	1.82	0.070	0.072
H	0.98	1.02	0.039	0.040
J	0.63	0.67	0.025	0.026
K	0.88	1.01	0.035	0.039
L	2.46	2.63	0.097	0.104
M	0.59	0.70	0.023	0.028
N	0.03	0.08	0.001	0.003
P	0.08	0.17	0.003	0.007

# IRF6603

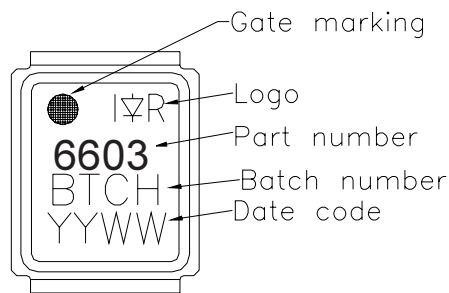
International  
**IR** Rectifier

## DirectFET™ Substrate and PCB Layout, MT Outline (MediumSize Can, T-Designation).

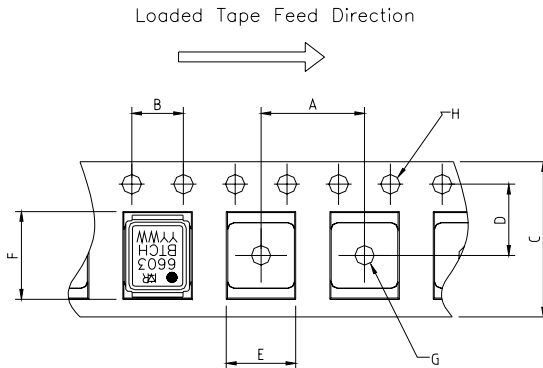
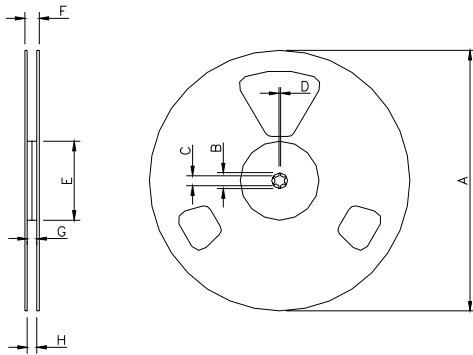
Please see DirectFET application note AN-1035 for all details regarding the assembly of DirectFET. This includes all recommendations for stencil and substrate designs.



## DirectFET™ Part Marking



## DirectFET™ Tape & Reel Dimension (Showing component orientation).



NOTE: Controlling dimensions in mm  
 Std reel quantity is 4800 parts. (ordered as IRF6603). For 1000 parts on 7" reel,  
 order IRF6603TR1

REEL DIMENSIONS								
CODE	STANDARD OPTION (QTY 4800)				TR1 OPTION (QTY 1000)			
	METRIC		IMPERIAL		METRIC		IMPERIAL	
	MIN	MAX	MIN	MAX	MIN	MAX	MIN	MAX
A	330.0	N.C	12.992	N.C	177.77	N.C	6.9	N.C
B	20.2	N.C	0.795	N.C	19.06	N.C	0.75	N.C
C	12.8	13.2	0.504	0.520	13.5	12.8	0.53	0.50
D	1.5	N.C	0.059	N.C	1.5	N.C	0.059	N.C
E	100.0	N.C	3.937	N.C	58.72	N.C	2.31	N.C
F	N.C	18.4	N.C	0.724	N.C	13.50	N.C	0.53
G	12.4	14.4	0.488	0.567	11.9	12.01	0.47	N.C
H	11.9	15.4	0.469	0.606	11.9	12.01	0.47	N.C

NOTE: CONTROLLING  
 DIMENSIONS IN MM

CODE	DIMENSIONS			
	METRIC		IMPERIAL	
	MIN	MAX	MIN	MAX
A	7.90	8.10	0.311	0.319
B	3.90	4.10	0.154	0.161
C	11.90	12.30	0.469	0.484
D	5.45	5.55	0.215	0.219
E	5.10	5.30	0.201	0.209
F	6.50	6.70	0.256	0.264
G	1.50	N.C	0.059	N.C
H	1.50	1.60	0.059	0.063

### Notes:

- ① Repetitive rating; pulse width limited by max. junction temperature.
- ② Starting  $T_J = 25^\circ\text{C}$ ,  $L = 0.24\text{mH}$   
 $R_G = 25\Omega$ ,  $I_{AS} = 20\text{A}$ .
- ③ Pulse width  $\leq 400\mu\text{s}$ ; duty cycle  $\leq 2\%$ .
- ④ Surface mounted on 1 in. square Cu board.
- ⑤ Used double sided cooling, mounting pad.
- ⑥ Mounted on minimum footprint full size board with metalized back and with small clip heatsink.
- ⑦  $T_C$  measured with thermal couple mounted to top (Drain) of part.
- ⑧  $R_{\theta}$  is measured at  $T_J$  of approximately  $90^\circ\text{C}$ .

Data and specifications subject to change without notice.  
 This product has been designed and qualified for the Consumer market.  
 Qualification Standards can be found on IR's Web site.

Note: For the most current drawings please refer to the IR website at:  
<http://www.irf.com/package/>