

5-V Low Drop Fixed Voltage Regulator

TLE 4270

Features

- Output voltage tolerance $\leq \pm 2\%$
- 650 mA output current capability
- Low-drop voltage
- Reset functionality
- Adjustable reset time
- Suitable for use in automotive electronics
- Integrated overtemperature protection
- Reverse polarity protection
- Input voltage up to 42 V
- Overvoltage protection up to 65 V (≤ 400 ms)
- Short-circuit proof
- Wide temperature range
- ESD protection > 4000 V

Functional Description

This device is a 5-V low drop fixed-voltage regulator. The maximum input voltage is 42 V (65 V, ≤ 400 ms). Up to an input voltage of 26 V and for an output current up to 650 mA it regulates the output voltage within a 2% accuracy. The short circuit protection limits the output current of more than 650 mA. The device incorporates overvoltage protection and a temperature protection which turns off the device at high temperatures.

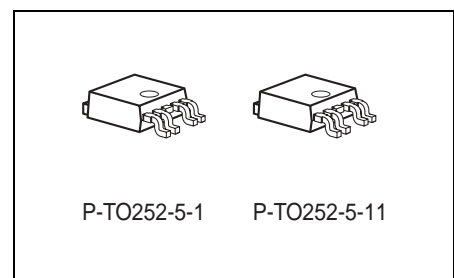
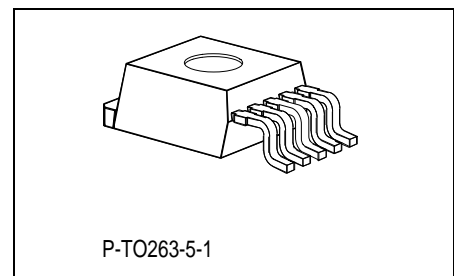
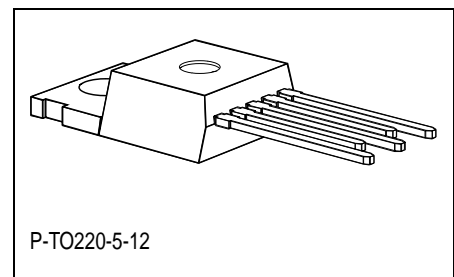
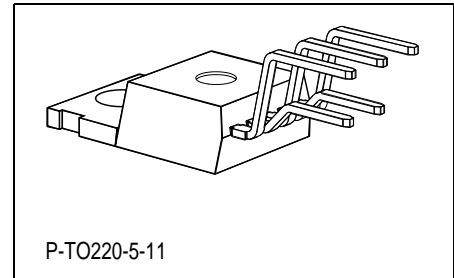

Type	Ordering Code	Package
TLE 4270	Q67000-A9209	P-TO220-5-11
TLE 4270 S	Q67000-A9243	P-TO220-5-12
TLE 4270 G	Q67006-A9201	P-TO263-5-1
TLE 4270 D	Q67006-A9360	P-TO252-5-1, P-TO252-5-11

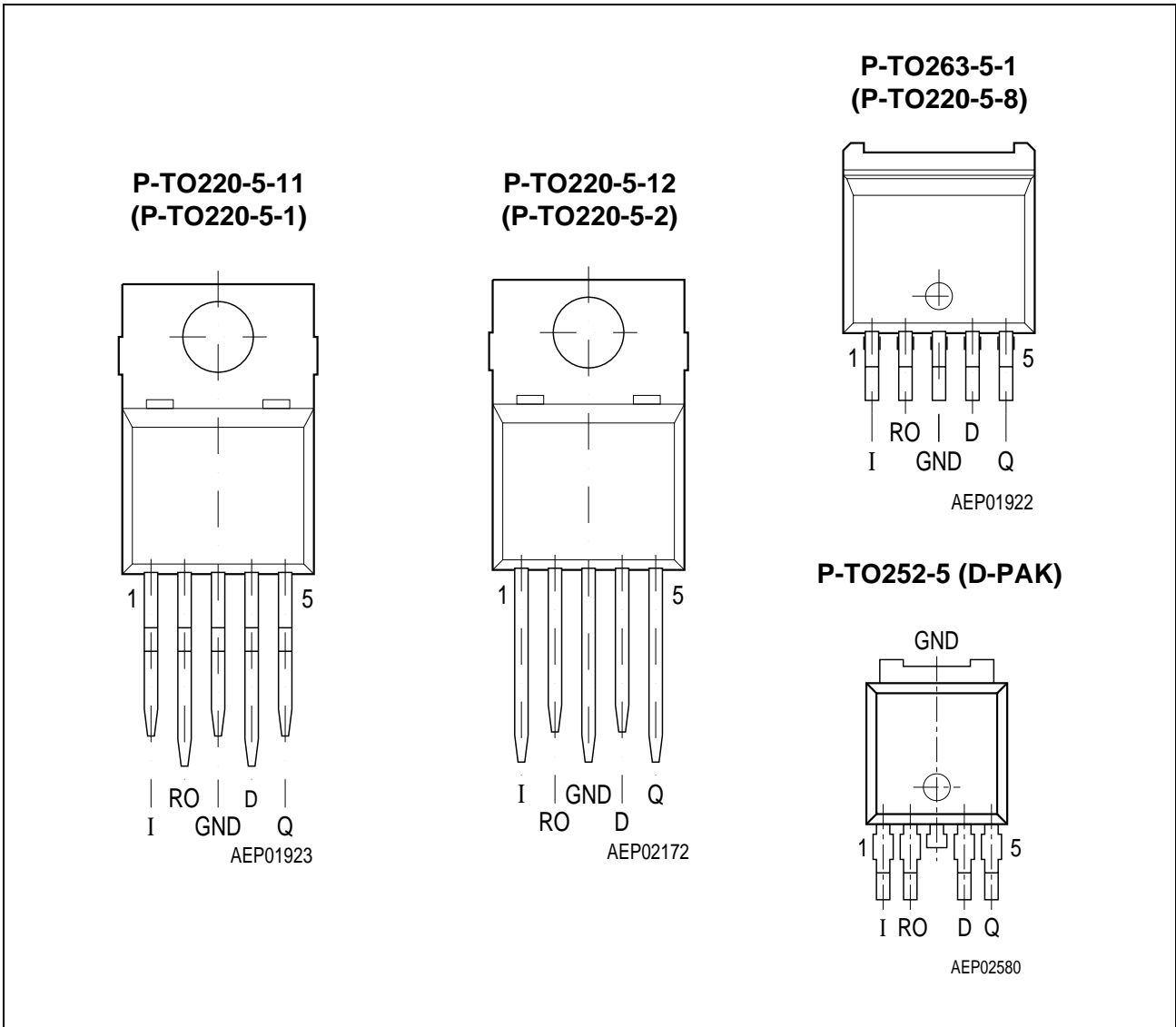

Figure 1 Pin Configuration (top view)

Table 1 Pin Definitions and Functions

Pin	Symbol	Function
1	I	Input ; block to ground directly at the IC with a ceramic capacitor.
2	RO	Reset Output ; the open collector output is connected to the 5-V output via an integrated resistor of 30 kΩ.
3	GND	Ground ; internally connected to heatsink.
4	D	Reset Delay ; connect a capacitor to ground for delay time adjustment.
5	Q	5-V Output ; block to ground with 22 μF capacitor, ESR < 3 Ω.

Circuit Description

The control amplifier compares a reference voltage, which is kept highly accurate by resistance adjustment, to a voltage that is proportional to the output voltage and drives the base of a series transistor via a buffer. Saturation control as a function of the load current prevents any over-saturation of the power element.

The IC also incorporates a number of internal circuits for protection against:

- Overload
- Overvoltage
- Overtemperature
- Reverse polarity

Application Description

The IC regulates an input voltage in the range of $5.5\text{ V} < V_I < 36\text{ V}$ to $V_{Q,\text{nom}} = 5.0\text{ V}$. Up to 26 V it produces a regulated output current of more than 650 mA. Above 26 V the save-operating-area protection allows operation up to 36 V with a regulated output current of more than 300 mA. Overvoltage protection limits operation at 42 V. The overvoltage protection hysteresis restores operation if the input voltage has dropped below 36 V. A reset signal is generated for an output voltage of $V_Q < 4.5\text{ V}$. The delay for power-on reset can be set externally with a capacitor.

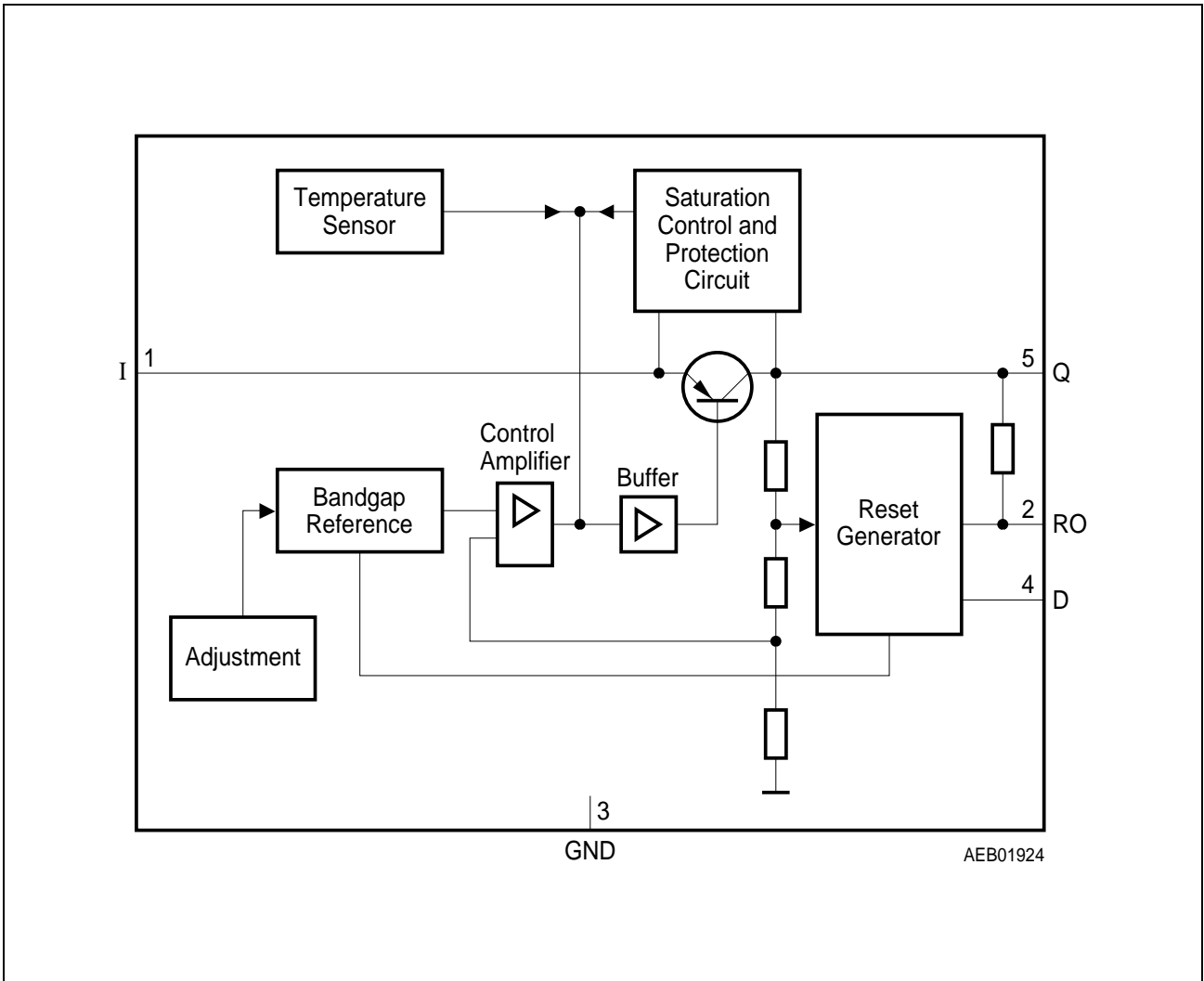

Figure 2 Block Diagram

Table 2 Absolute Maximum Ratings

$T_j = -40$ to 150 °C

Parameter	Symbol	Limit Values		Unit	Notes
		Min.	Max.		
Input I					
Voltage	V_I	-42	42	V	–
Voltage	V_I	–	65	V	$t \leq 400$ ms
Current	I_I	–	–	–	internally limited
Reset Output RO					
Voltage	V_{RO}	-0.3	7	V	–
Current	I_{RO}	–	–	–	Internally limited
Reset Delay D					
Voltage	V_D	-0.3	7	V	–
Current	I_D	–	–	–	Internally limited
Output Q					
Voltage	V_Q	-1.0	16	V	–
Current	I_Q	–	–	–	Internally limited
Ground GND					
Current	I_{GND}	-0.5	–	A	–
Temperatures					
Junction temperature	T_j	–	150	°C	–
Storage temperature	T_{stg}	-50	150	°C	–

Table 3 Operating Range

Parameter	Symbol	Limit Values		Unit	Notes
		Min.	Max.		
Input voltage	V_I	6	42	V	–
Junction temperature	T_j	-40	150	°C	–
Thermal Resistance					
Junction ambient	R_{thj-a}	–	65 79	K/W K/W	– TO263, TO252 ¹⁾
Junction case	R_{thj-c}	–	3	K/W	TO-220/263 Packages

1) Mounted on PCB, $80 \times 80 \times 1.5$ mm³; 35µ Cu; 5µ Sn; Footprint only; zero airflow.

Table 4 Characteristics
 $V_I = 13.5\text{ V}; -40\text{ }^\circ\text{C} \leq T_j \leq 125\text{ }^\circ\text{C}$ (unless otherwise specified)

Parameter	Symbol	Limit Values			Unit	Test Condition
		Min.	Typ.	Max.		
Output voltage	V_Q	4.90	5.00	5.10	V	$5\text{ mA} \leq I_Q \leq 550\text{ mA};$ $6\text{ V} \leq V_I \leq 26\text{ V}$
Output voltage	V_Q	4.90	5.00	5.10	V	$26\text{ V} \leq V_I \leq 36\text{ V};$ $I_Q \leq 300\text{ mA}$
Output current limiting	I_{Qmax}	650	850	–	mA	$V_Q = 0\text{ V}$
Current consumption $I_q = I_I - I_Q$	I_q	–	1	1.5	mA	$I_Q = 5\text{ mA}$
Current consumption $I_q = I_I - I_Q$	I_q	–	55	75	mA	$I_Q = 550\text{ mA}$
Current consumption $I_q = I_I - I_Q$	I_q	–	70	90	mA	$I_Q = 550\text{ mA}; V_I = 5\text{ V}$
Drop voltage	V_{DR}	–	350	700	mV	$I_Q = 550\text{ mA}^1)$
Load regulation	$\Delta V_{Q,Lo}$	–	25	50	mV	$I_Q = 5\text{ to }550\text{ mA};$ $V_I = 6\text{ V}$
Line regulation	$\Delta V_{Q,Li}$	–	12	25	mV	$V_I = 6\text{ to }26\text{ V}$ $I_Q = 5\text{ mA}$
Power supply Ripple rejection	$PSRR$	–	54	–	dB	$f_r = 100\text{ Hz};$ $V_r = 0.5\text{ Vpp}$

Reset Generator

Switching threshold	V_{RT}	4.5	4.65	4.8	V	–
Reset High voltage	V_{ROH}	4.5	–	–	V	–
Reset low voltage	V_{ROL}	–	60	–	mV	$R_{int} = 30\text{ k}\Omega^2);$ $1.0\text{ V} \leq V_Q \leq 4.5\text{ V}$
Reset low voltage	V_{ROL}	–	200	400	mV	$I_R = 3\text{ mA}, V_Q = 4.4\text{ V}$
Reset pull-up	R_{int}	18	30	46	k Ω	internally connected to Q
Charge current	$I_{D,c}$	8	14	25	μA	$V_D = 1.0\text{ V}$

Table 4 Characteristics (cont'd)

$V_I = 13.5\text{ V}; -40\text{ }^\circ\text{C} \leq T_j \leq 125\text{ }^\circ\text{C}$ (unless otherwise specified)

Parameter	Symbol	Limit Values			Unit	Test Condition
		Min.	Typ.	Max.		
Upper reset timing threshold	V_{DU}	1.4	1.8	2.3	V	–
Lower reset timing threshold	V_{DL}	0.2	0.45	0.8	V	$V_Q < V_{RT}$
Delay time	t_{rd}	–	13	–	ms	$C_D = 100\text{ nF}$
Reset reaction time	t_{rr}	–	–	3	μs	$C_D = 100\text{ nF}$

Overvoltage Protection

Turn-Off voltage	$V_{I,ov}$	42	44	46	V	–
------------------	------------	----	----	----	---	---

- 1) Drop voltage = $V_I - V_Q$ (measured when the output voltage has dropped 100 mV from the nominal value obtained at 13.5 V input)
- 2) Reset peak is always lower than 1.0 V.

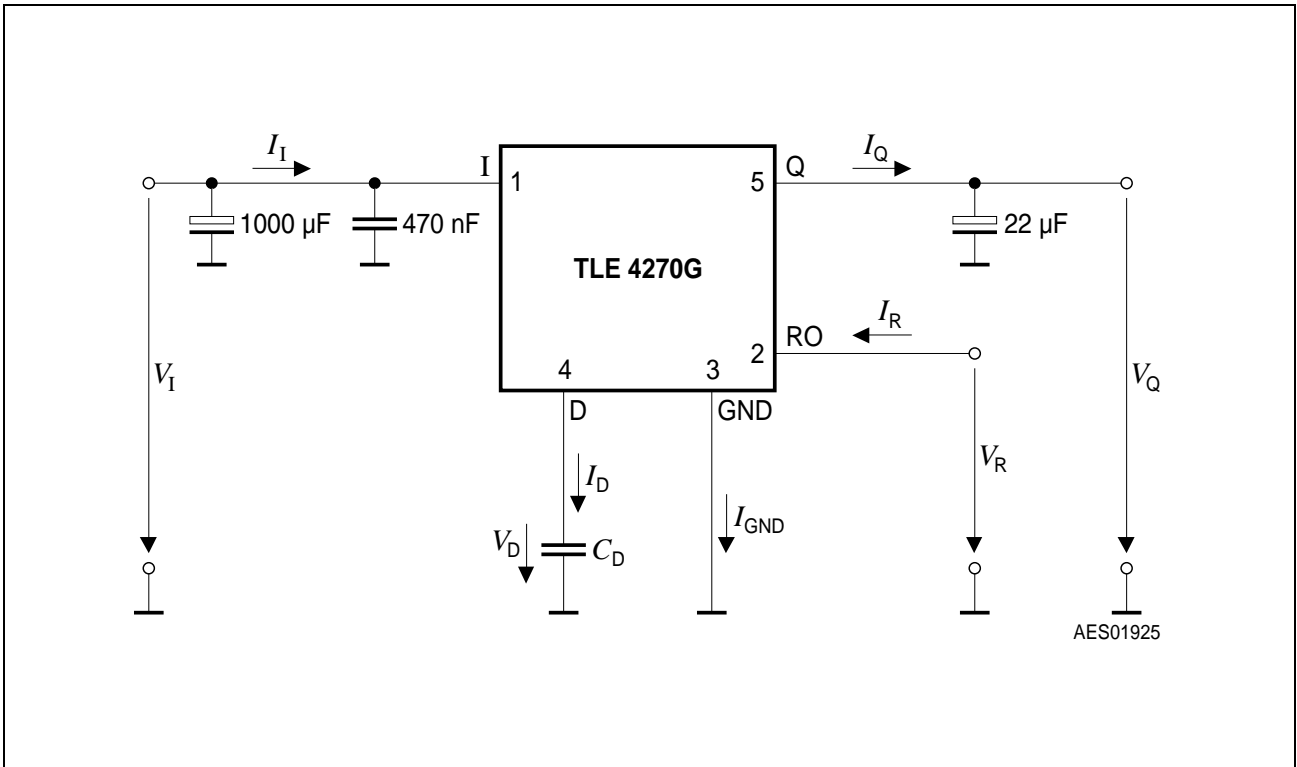

Figure 3 Test Circuit

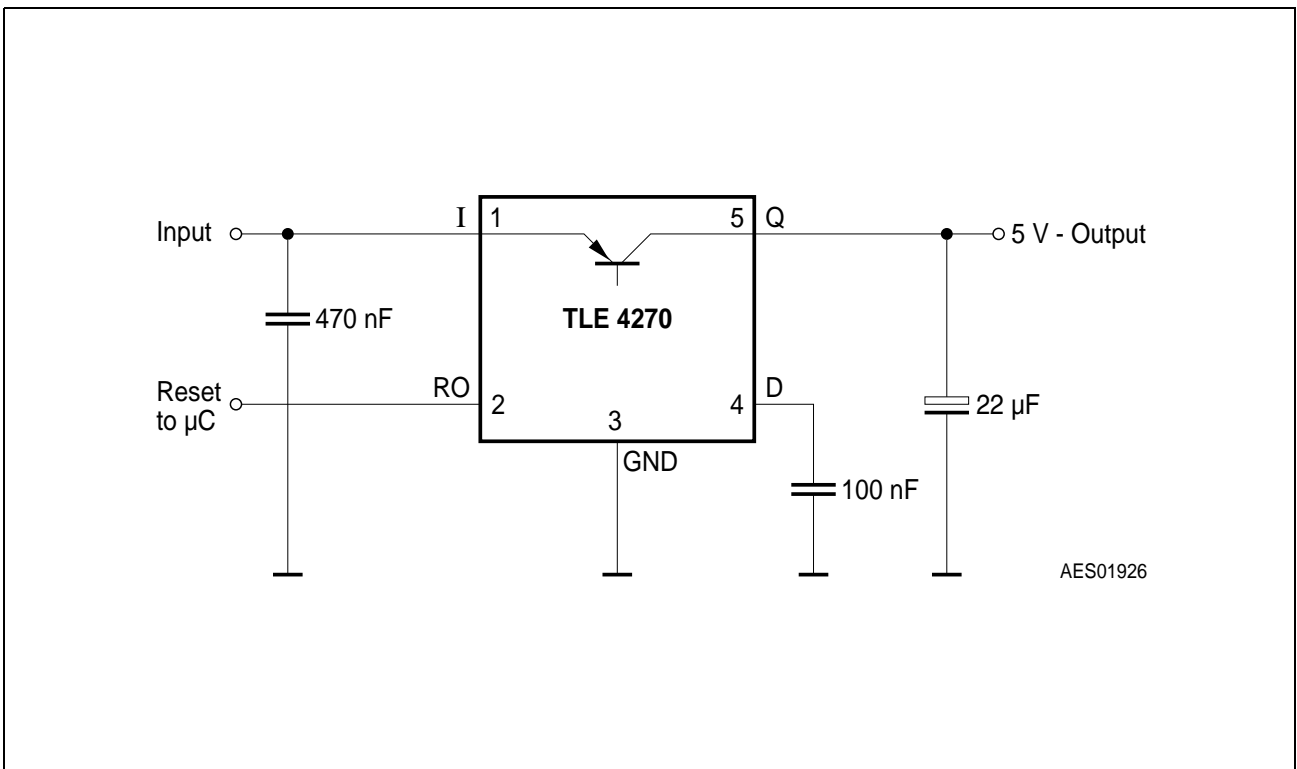

Figure 4 Application Circuit

Design Notes for External Components

An input capacitor C_I is necessary for compensation of line influences. The resonant circuit consisting of lead inductance and input capacitance can be damped by a resistor of approx. 1Ω in series with C_I . An output capacitor C_Q is necessary for the stability of the regulating circuit. Stability is guaranteed at values of $C_Q \geq 22 \mu\text{F}$ and an ESR of $< 3 \Omega$.

Reset Circuitry

If the output voltage decreases below 4.5 V , an external capacitor C_D on pin 4 (D) will be discharged by the reset generator. If the voltage on this capacitor drops below V_{DL} , a reset signal is generated on pin 2 (RO), i.e. reset output is set low. If the output voltage rises above the reset threshold, C_D will be charged with constant current. After the power-on-reset time the voltage on the capacitor reaches V_{DU} and the reset output will be set high again. The value of the power-on-reset time can be set within a wide range depending of the capacitance of C_D .

Reset Timing

The power-on reset delay time is defined by the charging time of an external capacitor C_D which can be calculated as follows:

$$C_D = (\Delta t \times I_{D,c}) / \Delta V \tag{1}$$

Definitions:

- C_D = delay capacitors
- Δt = reset delay time t_{rd}
- $I_{D,c}$ = charge current, typical $14 \mu\text{A}$
- $\Delta V = V_{DU}$, typical 1.8 V

V_{DU} = upper reset timing threshold at C_D for reset delay time

$$t_{rd} = \Delta V \times C_D / I_{D,c} \tag{2}$$

The reset reaction time t_{rr} is the time it takes the voltage regulator to set the reset out LOW after the output voltage has dropped below the reset threshold. It is typically $1 \mu\text{s}$ for delay capacitor of 47 nF . For other values for C_D the reaction time can be estimated using the following equation:

$$t_{rr} \approx 20 \text{ s/F} \times C_D \tag{3}$$

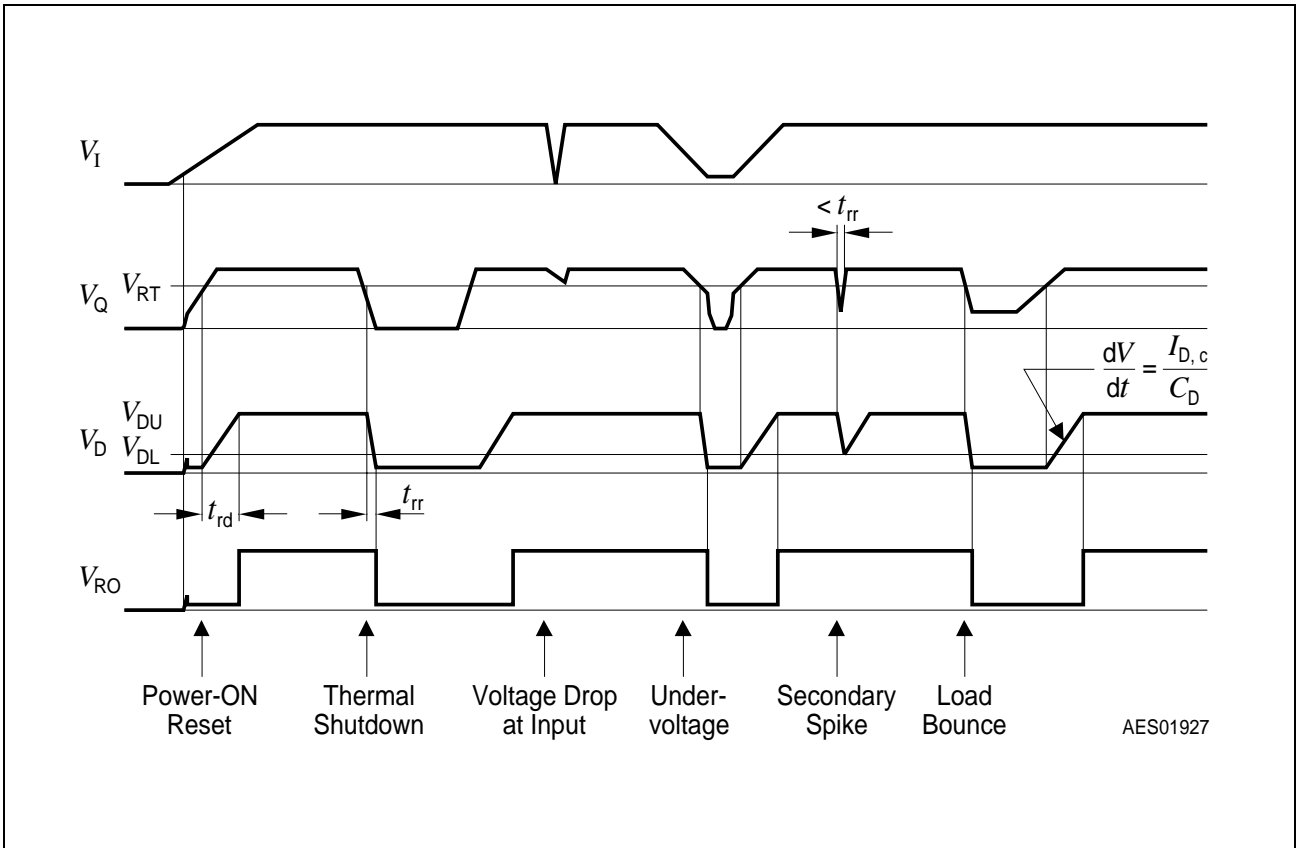
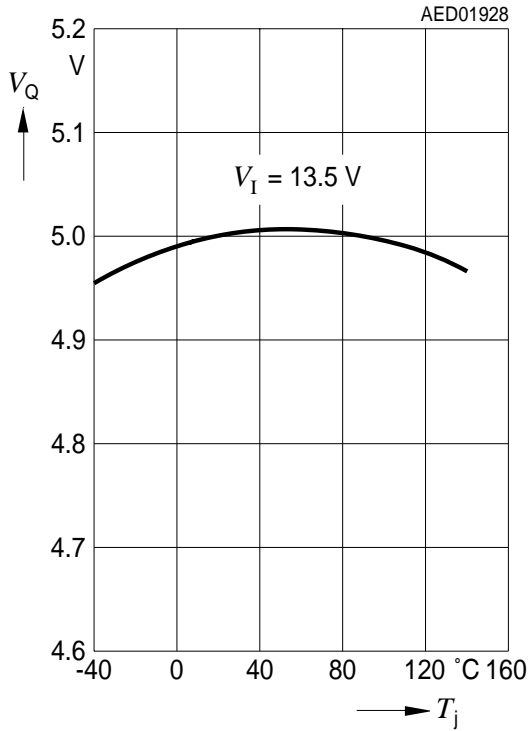
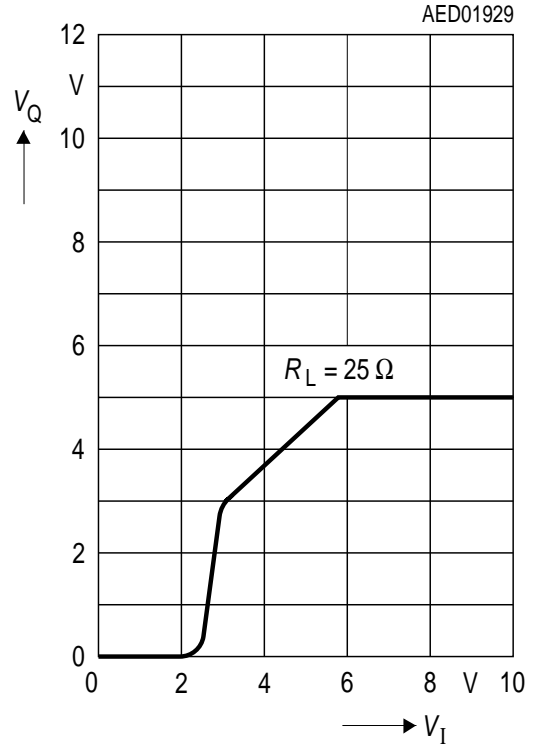

Figure 5 Reset Time Response

Output Voltage V_Q versus Temperature T_j



Output Voltage V_Q versus Input Voltage V_I



Output Current I_Q versus Temperature T_j

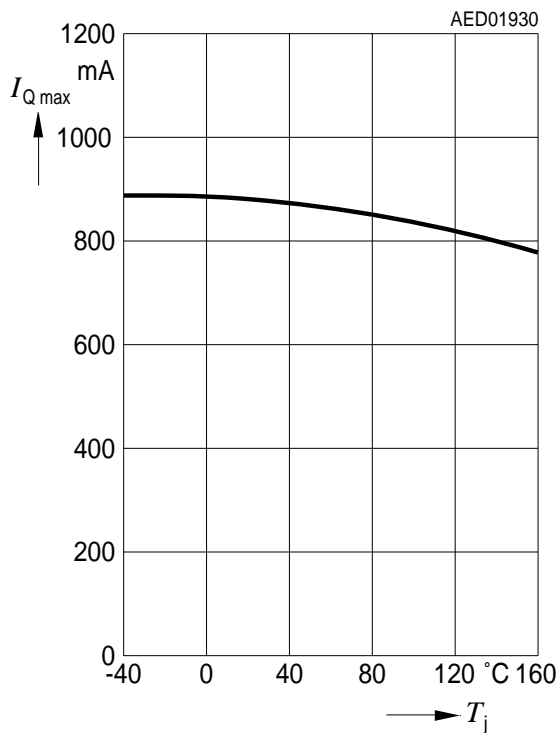

Output Current I_Q versus Input Voltage V_I

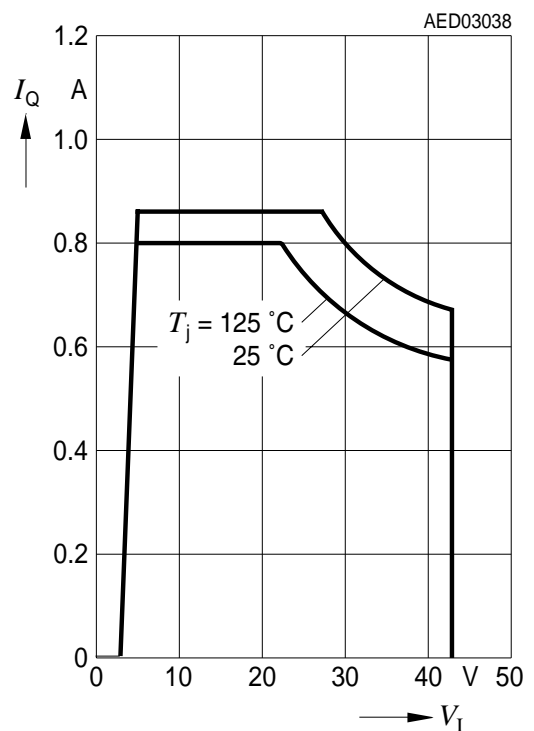

Current Consumption I_q versus Output Current I_Q

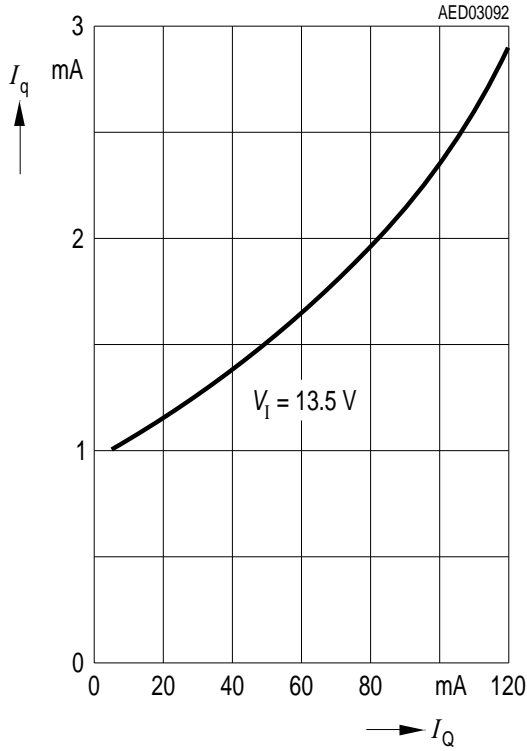

Current Consumption I_q versus Output Current I_Q

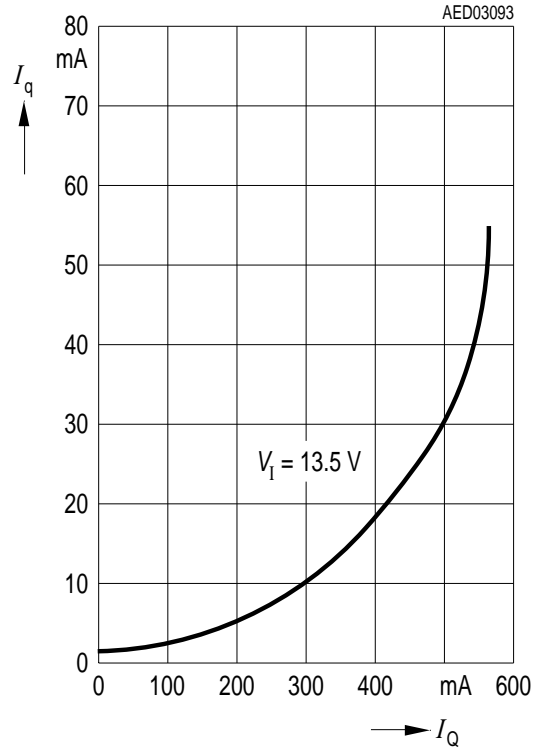

Current Consumption I_q versus Input Voltage V_I

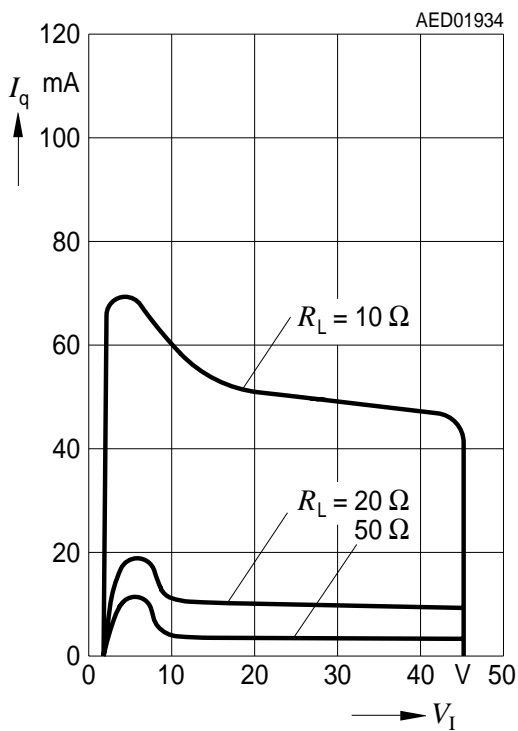

Drop Voltage V_{DR} versus Output Current I_Q

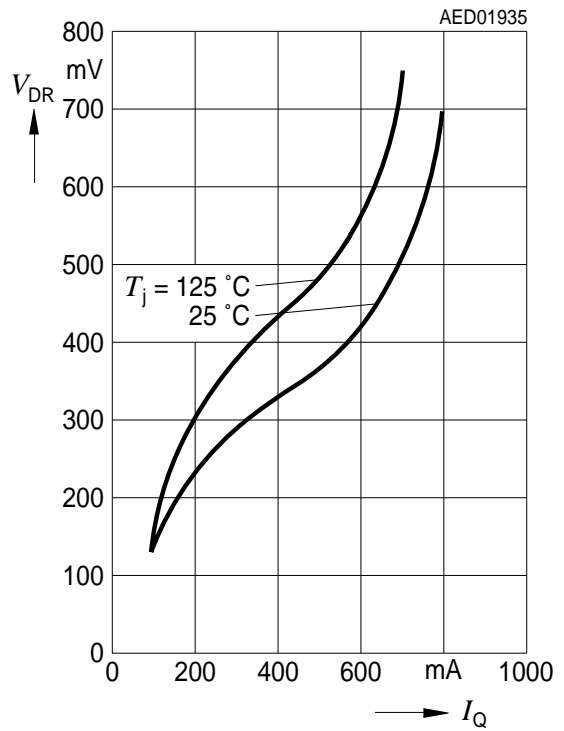

Charge Current $I_{D,c}$ versus Temperature T_j

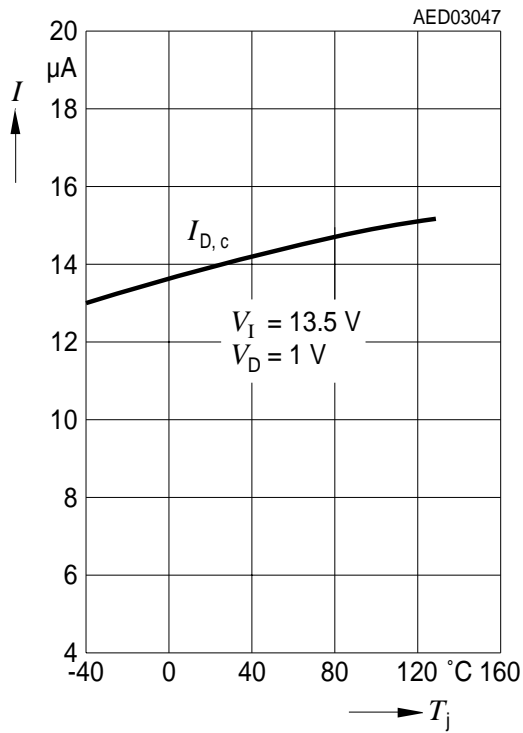

Upper Reset Timing Threshold V_{DU} versus Temperature T_j

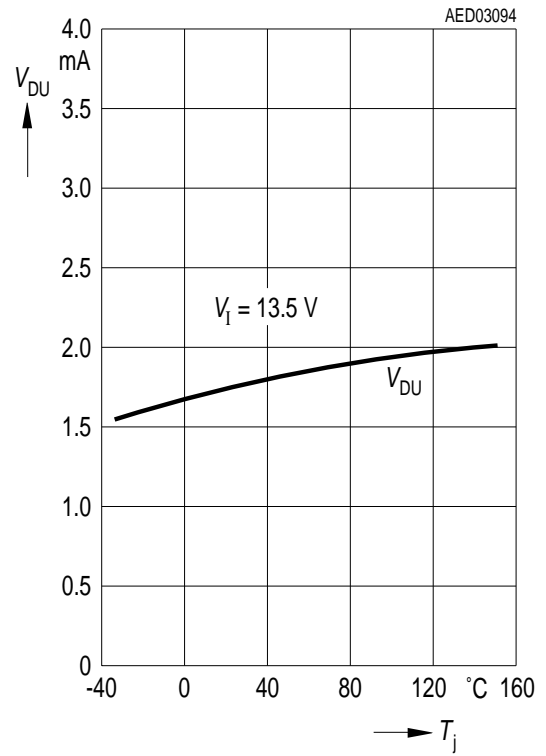

Package Outlines

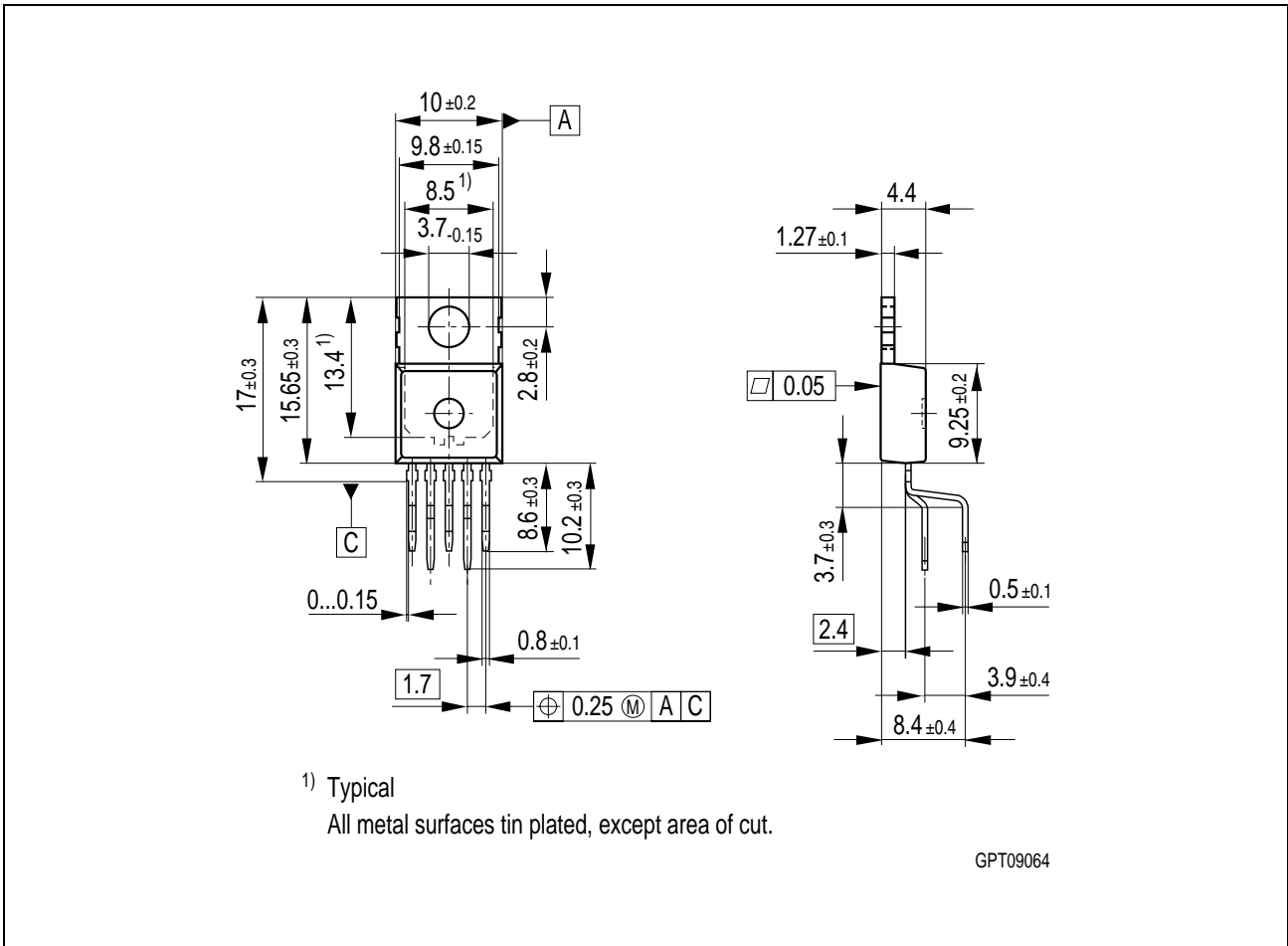

Figure 6 P-T0220-5-11 (Plastic Transistor Single Outline)

You can find all of our packages, sorts of packing and others in our Infineon Internet Page "Products": <http://www.infineon.com/products>.

SMD = Surface Mounted Device

Dimensions in mm

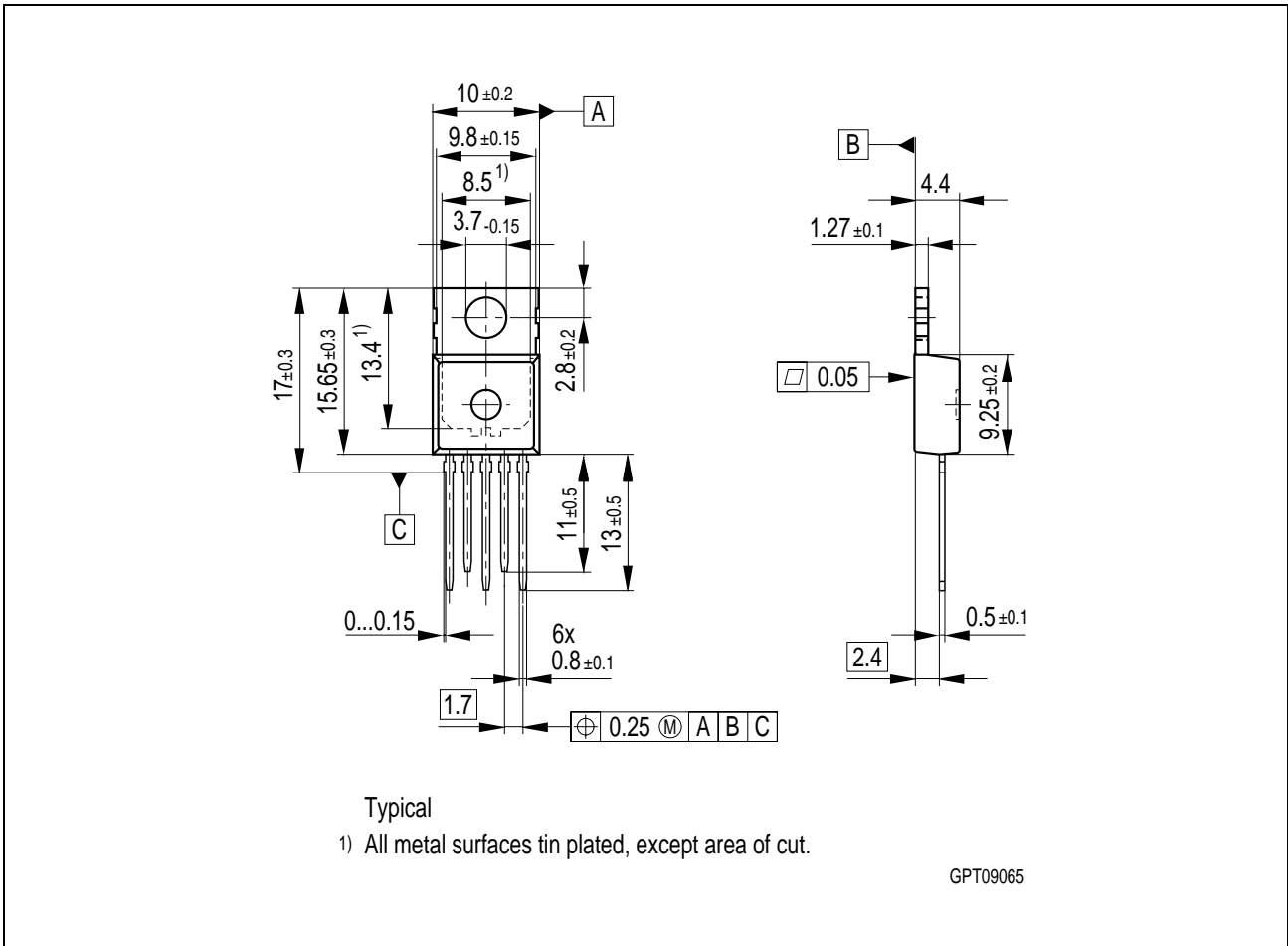

Figure 7 P-T0220-5-12 (Plastic Transistor Single Outline)

You can find all of our packages, sorts of packing and others in our Infineon Internet Page "Products": <http://www.infineon.com/products>.

SMD = Surface Mounted Device

Dimensions in mm

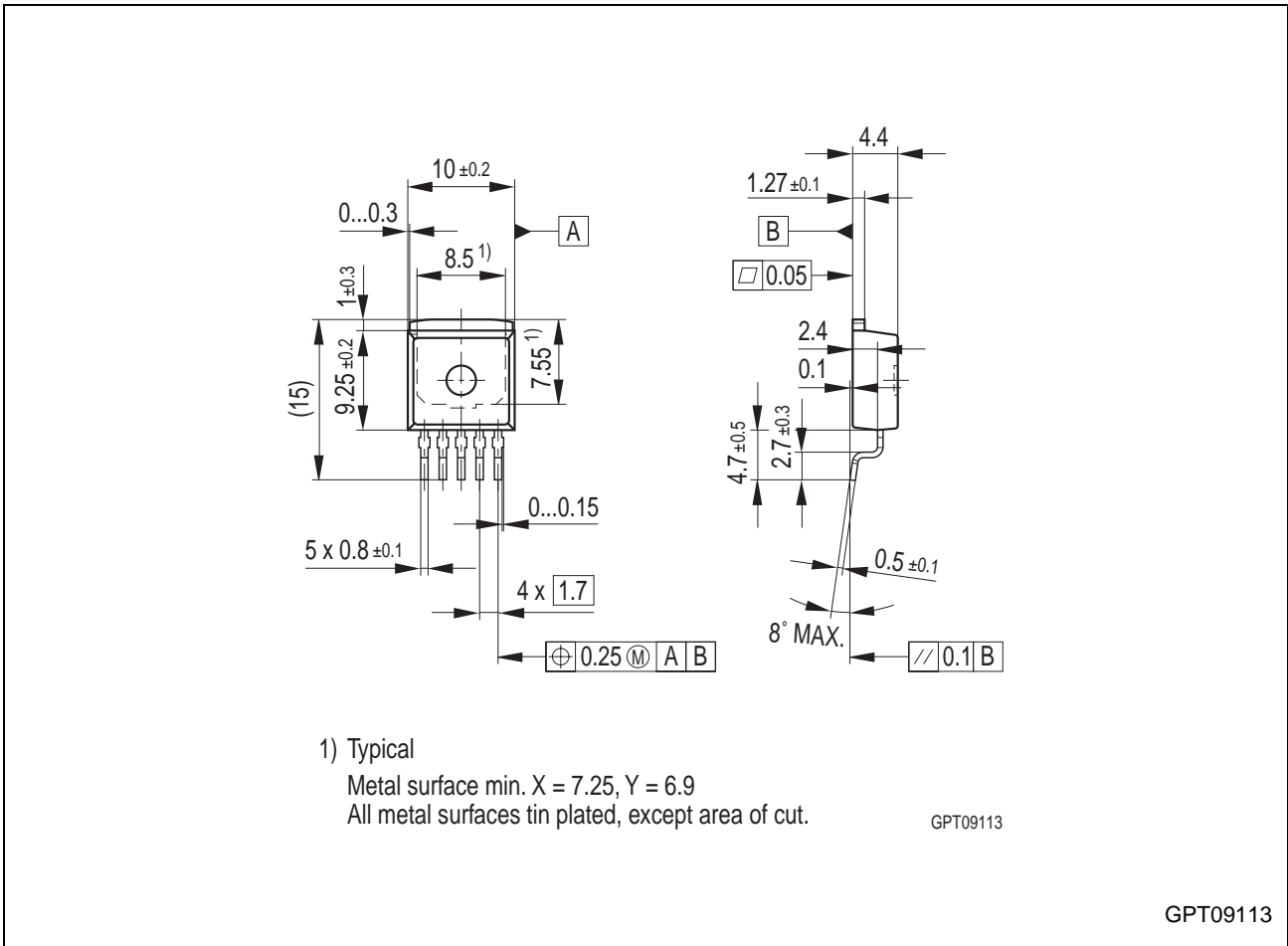

Figure 8 P-TO263-5-1 (Plastic Transistor Single Outline)

You can find all of our packages, sorts of packing and others in our Infineon Internet Page "Products": <http://www.infineon.com/products>.

SMD = Surface Mounted Device

Dimensions in mm

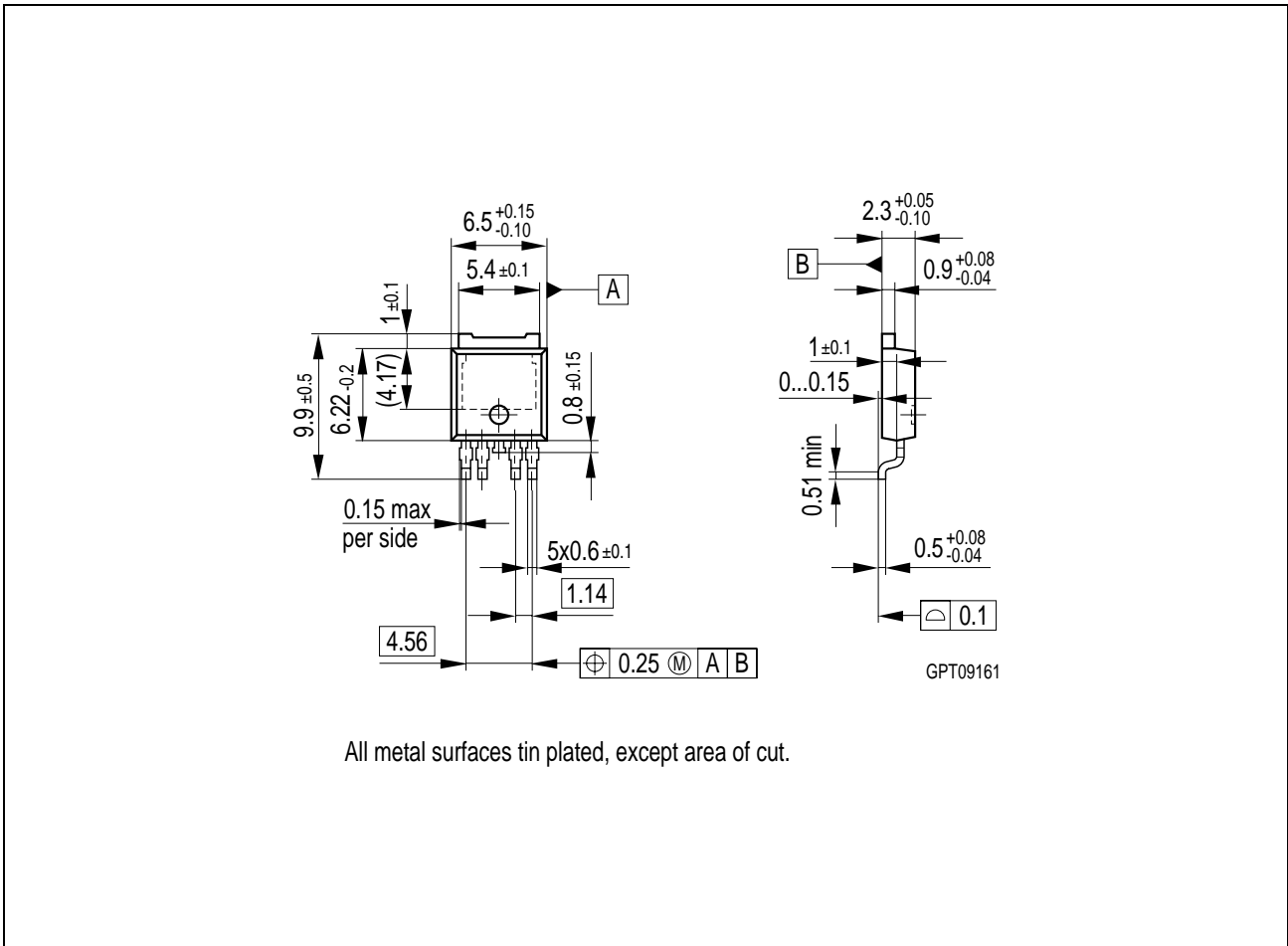

Figure 9 P-TO252-5-1 (Plastic Transistor Single Outline)

You can find all of our packages, sorts of packing and others in our Infineon Internet Page "Products": <http://www.infineon.com/products>.

SMD = Surface Mounted Device

Dimensions in mm

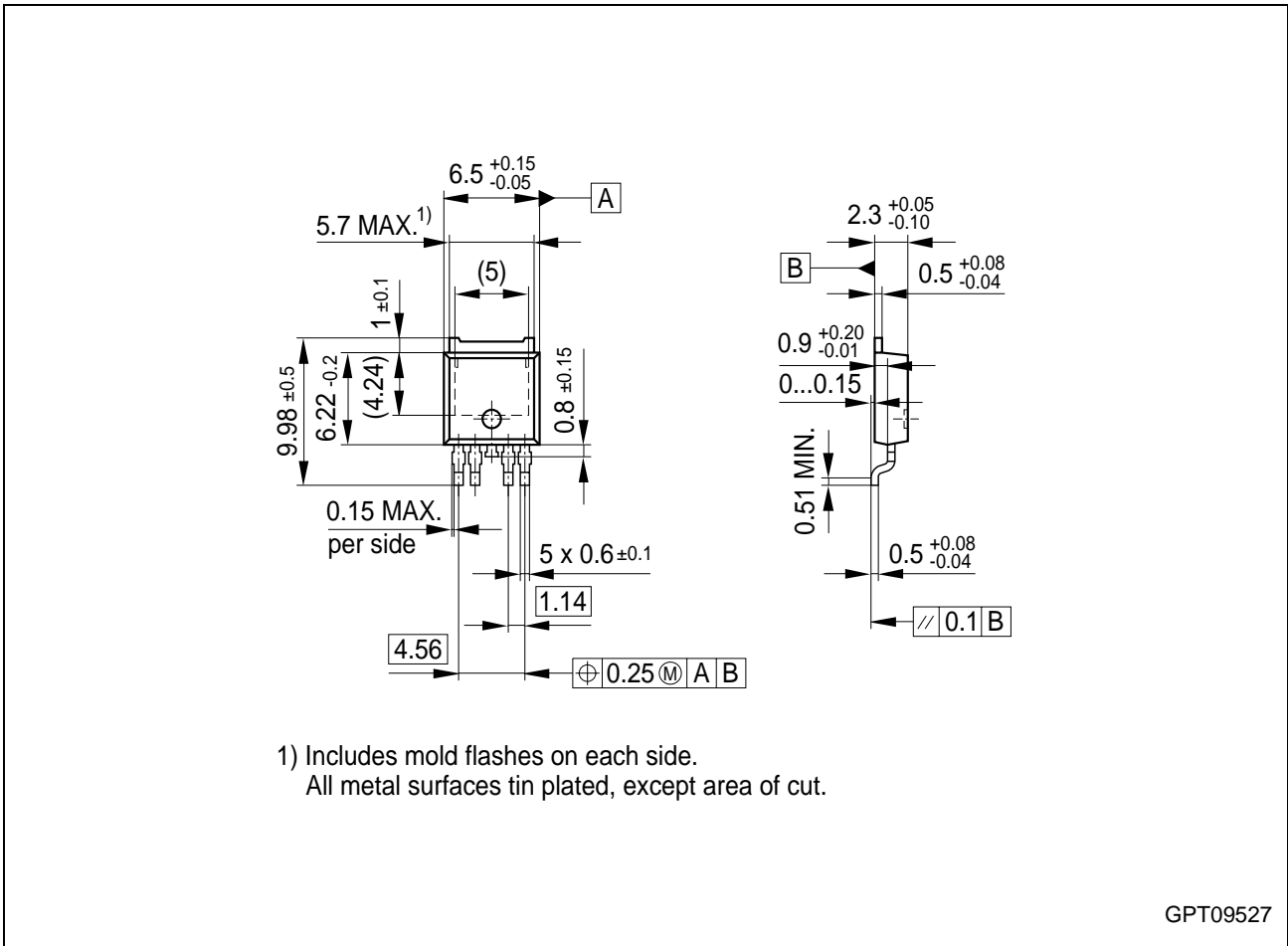

Figure 10 P-TO252-5-11 (Plastic Transistor Single Outline)

You can find all of our packages, sorts of packing and others in our Infineon Internet Page "Products": <http://www.infineon.com/products>.

SMD = Surface Mounted Device

Dimensions in mm

Remarks

Edition 2005-08-09

**Published by Infineon Technologies AG,
St.-Martin-Strasse 53,
81669 München, Germany**

**© Infineon Technologies AG 2004.
All Rights Reserved.**

Attention please!

The information herein is given to describe certain components and shall not be considered as a guarantee of characteristics.

Terms of delivery and rights to technical change reserved.

We hereby disclaim any and all warranties, including but not limited to warranties of non-infringement, regarding circuits, descriptions and charts stated herein.

Information

For further information on technology, delivery terms and conditions and prices please contact your nearest Infineon Technologies Office (www.infineon.com).

Warnings

Due to technical requirements components may contain dangerous substances. For information on the types in question please contact your nearest Infineon Technologies Office.

Infineon Technologies Components may only be used in life-support devices or systems with the express written approval of Infineon Technologies, if a failure of such components can reasonably be expected to cause the failure of that life-support device or system, or to affect the safety or effectiveness of that device or system. Life support devices or systems are intended to be implanted in the human body, or to support and/or maintain and sustain and/or protect human life. If they fail, it is reasonable to assume that the health of the user or other persons may be endangered.