

**RADIATION HARDENED  
 POWER MOSFET  
 SURFACE MOUNT (SMD-2)**

**IRHNA7360SE  
 400V, N-CHANNEL  
 RAD Hard™ HEXFET® TECHNOLOGY**

**Product Summary**

Part Number	Radiation Level	R <sub>DS(on)</sub>	I <sub>D</sub>
IRHNA7360SE	100K Rads (Si)	0.20Ω	24A

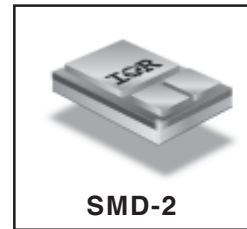

**SMD-2**

International Rectifier's RADHard™ HEXFET® MOSFET technology provides high performance power MOSFETs for space applications. This technology has over a decade of proven performance and reliability in satellite applications. These devices have been characterized for both Total Dose and Single Event Effects (SEE). The combination of low R<sub>DS(on)</sub> and low gate charge reduces the power losses in switching applications such as DC to DC converters and motor control. These devices retain all of the well established advantages of MOSFETs such as voltage control, fast switching, ease of paralleling and temperature stability of electrical parameters.

**Features:**

- Single Event Effect (SEE) Hardened
- Ultra Low R<sub>DS(on)</sub>
- Low Total Gate Charge
- Simple Drive Requirements
- Ease of Paralleling
- Hermetically Sealed
- Surface Mount
- Light Weight

**Absolute Maximum Ratings**

**Pre-Irradiation**

	Parameter		Units
I <sub>D</sub> @ V <sub>GS</sub> = 12V, T <sub>C</sub> = 25°C	Continuous Drain Current	24	A
I <sub>D</sub> @ V <sub>GS</sub> = 12V, T <sub>C</sub> = 100°C	Continuous Drain Current	15	
I <sub>DM</sub>	Pulsed Drain Current ①	96	
P <sub>D</sub> @ T <sub>C</sub> = 25°C	Max. Power Dissipation	300	W
	Linear Derating Factor	2.4	W/°C
V <sub>GS</sub>	Gate-to-Source Voltage	±20	V
EAS	Single Pulse Avalanche Energy ②	310	mJ
I <sub>AR</sub>	Avalanche Current ①	24	A
E <sub>AR</sub>	Repetitive Avalanche Energy ①	30	mJ
dv/dt	Peak Diode Recovery dv/dt ③	3.0	V/ns
T <sub>J</sub>	Operating Junction	-55 to 150	°C
T <sub>STG</sub>	Storage Temperature Range		
	Package Mounting Surface Temperature	300 (for 5 sec.)	
	Weight	3.3 (Typical)	g

For footnotes refer to the last page

**Electrical Characteristics @ T<sub>j</sub> = 25°C (Unless Otherwise Specified)**

	Parameter	Min	Typ	Max	Units	Test Conditions
BV <sub>DSS</sub>	Drain-to-Source Breakdown Voltage	400	—	—	V	V <sub>GS</sub> = 0V, I <sub>D</sub> = 1.0mA
ΔBV <sub>DSS</sub> /ΔT <sub>J</sub>	Temperature Coefficient of Breakdown Voltage	—	0.51	—	V/°C	Reference to 25°C, I <sub>D</sub> = 1.0mA
R <sub>DS(on)</sub>	Static Drain-to-Source On-State Resistance	—	—	0.20	Ω	V <sub>GS</sub> = 12V, I <sub>D</sub> = 15A
		—	—	0.21		V <sub>GS</sub> = 12V, I <sub>D</sub> = 24A ④
V <sub>GS(th)</sub>	Gate Threshold Voltage	2.5	—	4.5	V	V <sub>DS</sub> = V <sub>GS</sub> , I <sub>D</sub> = 1.0mA
g <sub>fs</sub>	Forward Transconductance	4.0	—	—	S (r̄)	V <sub>DS</sub> > 15V, I <sub>DS</sub> = 15A ④
I <sub>DSS</sub>	Zero Gate Voltage Drain Current	—	—	50	μA	V <sub>DS</sub> = 320V, V <sub>GS</sub> = 0V
		—	—	250		V <sub>DS</sub> = 320V, V <sub>GS</sub> = 0V, T <sub>J</sub> = 125°C
I <sub>GSS</sub>	Gate-to-Source Leakage Forward	—	—	100	nA	V <sub>GS</sub> = 20V
I <sub>GSS</sub>	Gate-to-Source Leakage Reverse	—	—	-100		V <sub>GS</sub> = -20V
Q <sub>g</sub>	Total Gate Charge	—	—	250	nC	V <sub>GS</sub> = 12V, I <sub>D</sub> = 24A V <sub>DS</sub> = 200V
Q <sub>gs</sub>	Gate-to-Source Charge	—	—	60		
Q <sub>gd</sub>	Gate-to-Drain ('Miller') Charge	—	—	120		
t <sub>d(on)</sub>	Turn-On Delay Time	—	—	35	ns	V <sub>DD</sub> = 200V, I <sub>D</sub> = 24A, V <sub>GS</sub> = 12V, R <sub>G</sub> = 2.35Ω
t <sub>r</sub>	Rise Time	—	—	100		
t <sub>d(off)</sub>	Turn-Off Delay Time	—	—	120		
t <sub>f</sub>	Fall Time	—	—	100		
L <sub>S</sub> + L <sub>D</sub>	Total Inductance	—	4.0	—	nH	Measured from the center of drain pad to center of source pad
C <sub>iss</sub>	Input Capacitance	—	4000	—	pF	V <sub>GS</sub> = 0V, V <sub>DS</sub> = 25V f = 1.0MHz
C <sub>oss</sub>	Output Capacitance	—	1000	—		
C <sub>rss</sub>	Reverse Transfer Capacitance	—	460	—		

**Source-Drain Diode Ratings and Characteristics**

	Parameter	Min	Typ	Max	Units	Test Conditions
I <sub>S</sub>	Continuous Source Current (Body Diode)	—	—	24	A	
I <sub>SM</sub>	Pulse Source Current (Body Diode) ①	—	—	96		
V <sub>SD</sub>	Diode Forward Voltage	—	—	1.4	V	T <sub>J</sub> = 25°C, I <sub>S</sub> = 24A, V <sub>GS</sub> = 0V ④
t <sub>rr</sub>	Reverse Recovery Time	—	—	750	nS	T <sub>J</sub> = 25°C, I <sub>F</sub> = 24A, di/dt ≤ 100A/μs
Q <sub>RR</sub>	Reverse Recovery Charge	—	—	14	μC	V <sub>DD</sub> ≤ 50V ④
t <sub>on</sub>	Forward Turn-On Time	Intrinsic turn-on time is negligible. Turn-on speed is substantially controlled by L <sub>S</sub> + L <sub>D</sub> .				

**Thermal Resistance**

	Parameter	Min	Typ	Max	Units	Test Conditions
R <sub>thJC</sub>	Junction-to-Case	—	—	0.42	°C/W	Soldered to a 2 inch sq. clad PC board
R <sub>thJ-PCB</sub>	Junction-to-PC board	—	1.6	—		

Note: Corresponding Spice and Saber models are available on International Rectifier Website.

For footnotes refer to the last page

## Pre-Irradiation

## IRHNA7360SE

International Rectifier Radiation Hardened MOSFETs are tested to verify their radiation hardness capability. The hardness assurance program at International Rectifier is comprised of two radiation environments. Every manufacturing lot is tested for total ionizing dose (per notes 5 and 6) using the TO-3 package. Both pre- and post-irradiation performance are tested and specified using the same drive circuitry and test conditions in order to provide a direct comparison.

**Table 1. Electrical Characteristics @ T<sub>j</sub> = 25°C, Post Total Dose Irradiation ⑤⑥**

	Parameter	100K Rads (Si)		Units	Test Conditions ⑤
		Min	Max		
BV <sub>DSS</sub>	Drain-to-Source Breakdown Voltage	400	—	V	V <sub>GS</sub> = 0V, I <sub>D</sub> = 1.0mA
V <sub>GS(th)</sub>	Gate Threshold Voltage	2.0	4.5		V <sub>GS</sub> = V <sub>DS</sub> , I <sub>D</sub> = 1.0mA
I <sub>GSS</sub>	Gate-to-Source Leakage Forward	—	100	nA	V <sub>GS</sub> = 20V
I <sub>GSS</sub>	Gate-to-Source Leakage Reverse	—	-100		V <sub>GS</sub> = -20V
I <sub>DSS</sub>	Zero Gate Voltage Drain Current	—	50	μA	V <sub>DS</sub> = 320V, V <sub>GS</sub> = 0V
R <sub>DS(on)</sub>	Static Drain-to-Source ④ On-State Resistance (TO-3)	—	0.20	Ω	V <sub>GS</sub> = 12V, I <sub>D</sub> = 15A
R <sub>DS(on)</sub>	Static Drain-to-Source ④ On-State Resistance (SMD-2)	—	0.20	Ω	V <sub>GS</sub> = 12V, I <sub>D</sub> = 15A
V <sub>SD</sub>	Diode Forward Voltage ④	—	1.4	V	V <sub>GS</sub> = 0V, I <sub>D</sub> = 24A

International Rectifier radiation hardened MOSFETs have been characterized in heavy ion environment for Single Event Effects (SEE). Single Event Effects characterization is illustrated in Fig. a and Table 2.

**Table 2. Single Event Effect Safe Operating Area**

Ion	LET MeV/(mg/cm <sup>2</sup> )	Energy (MeV)	Range (μm)	V <sub>DS</sub> (V)				
				@V <sub>GS</sub> = 0V	@V <sub>GS</sub> = -5V	@V <sub>GS</sub> = -10V	@V <sub>GS</sub> = -15V	@V <sub>GS</sub> = -20V
Cu	28	285	43	325	325	325	325	325
Br	36.8	305	39	325	325	325	325	320

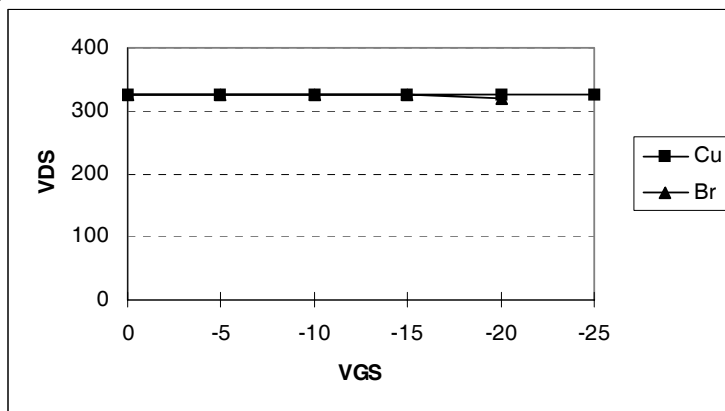

**Fig a. Single Event Effect, Safe Operating Area**

For footnotes refer to the last page

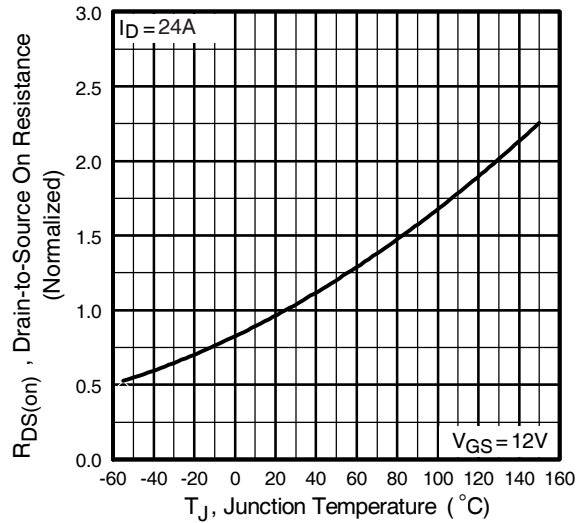
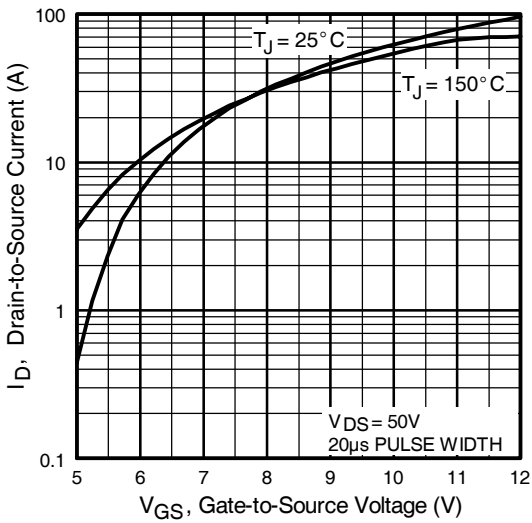
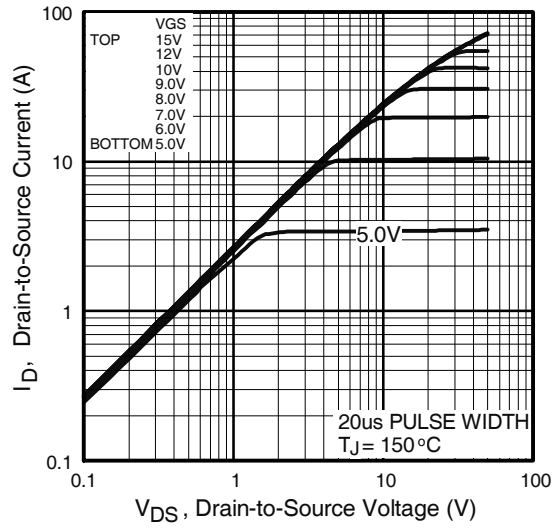
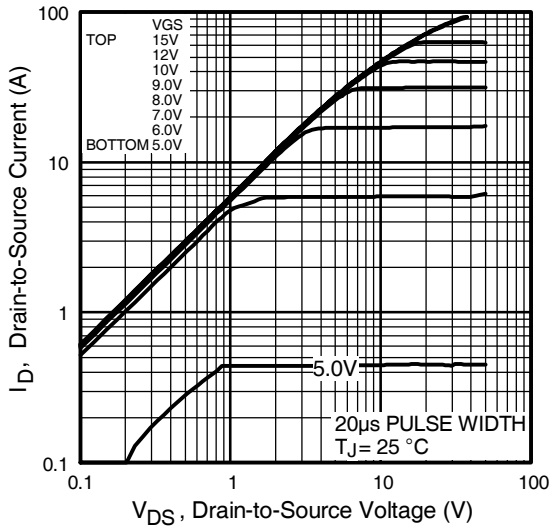

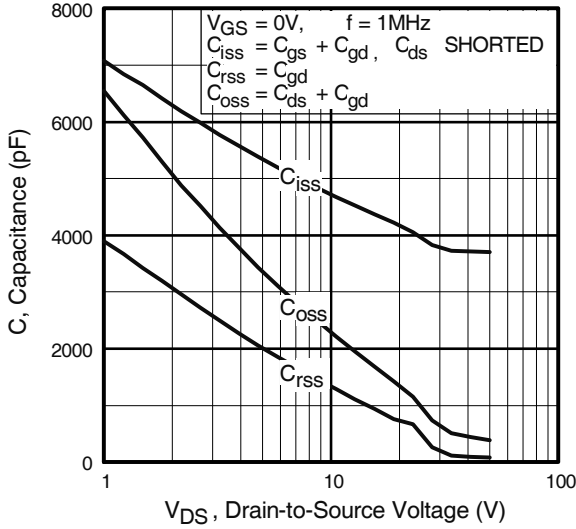

Fig 5. Typical Capacitance Vs. Drain-to-Source Voltage

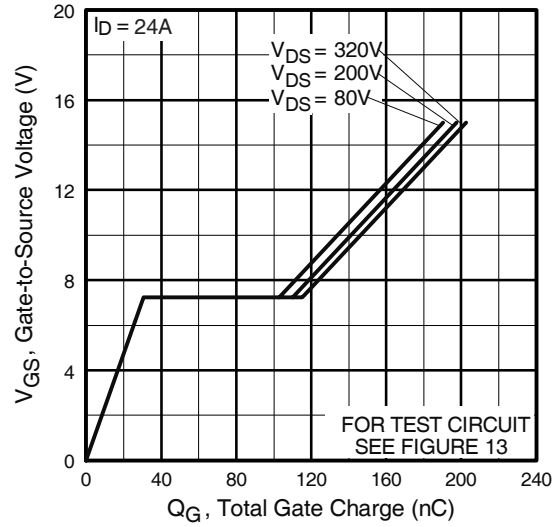

Fig 6. Typical Gate Charge Vs. Gate-to-Source Voltage

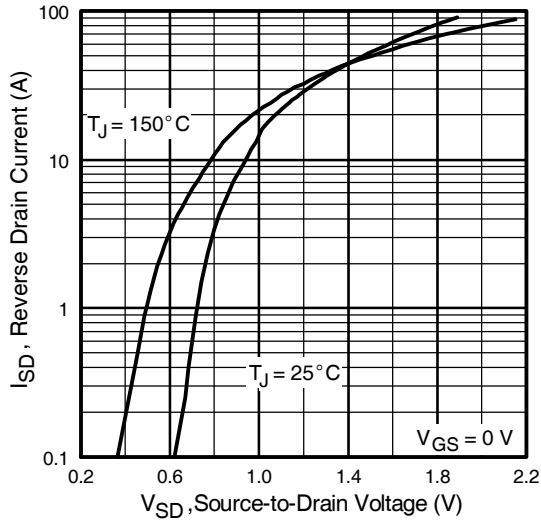

Fig 7. Typical Source-Drain Diode Forward Voltage

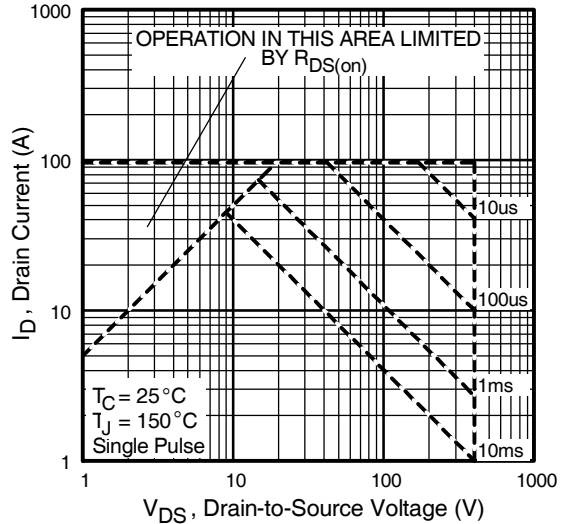
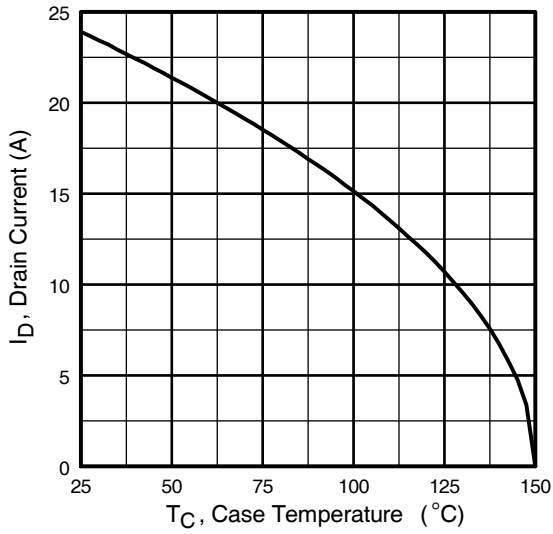
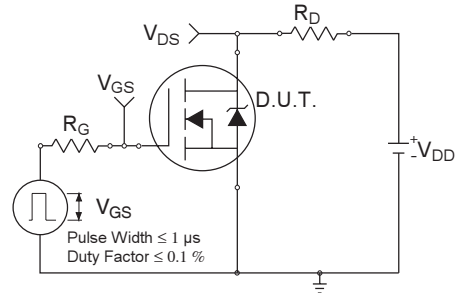

Fig 8. Maximum Safe Operating Area



**Fig 9.** Maximum Drain Current Vs. Case Temperature



**Fig 10a.** Switching Time Test Circuit

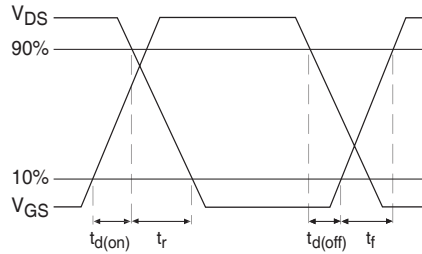

**Fig 10b.** Switching Time Waveforms

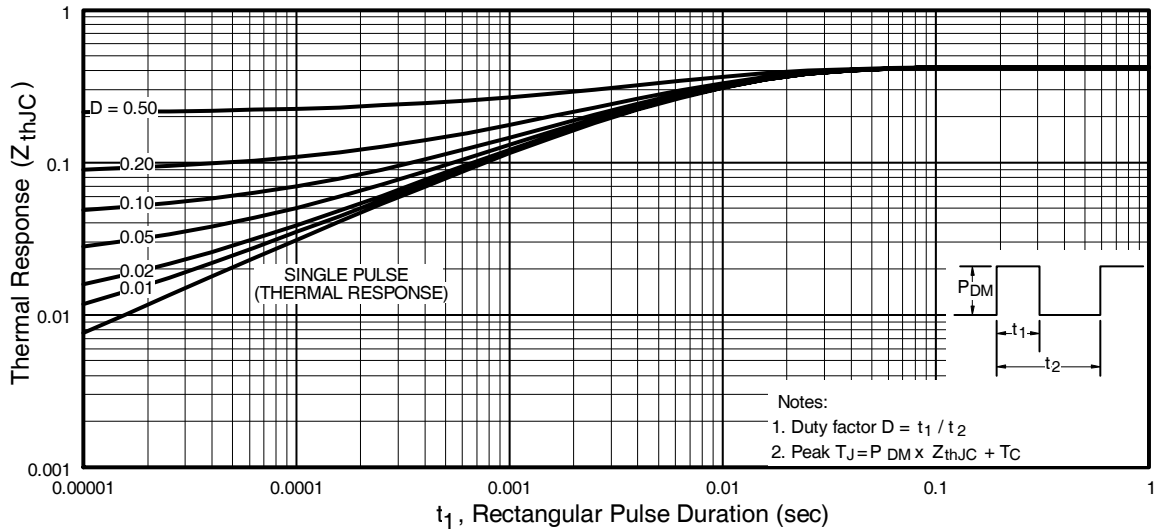

**Fig 11.** Maximum Effective Transient Thermal Impedance, Junction-to-Case

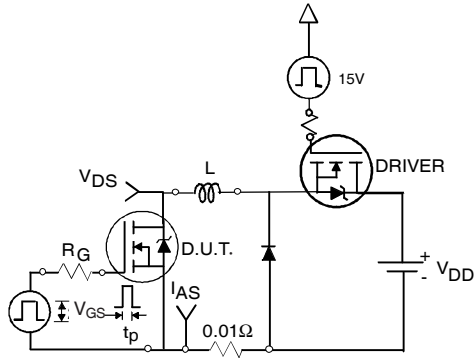

Fig 12a. Unclamped Inductive Test Circuit

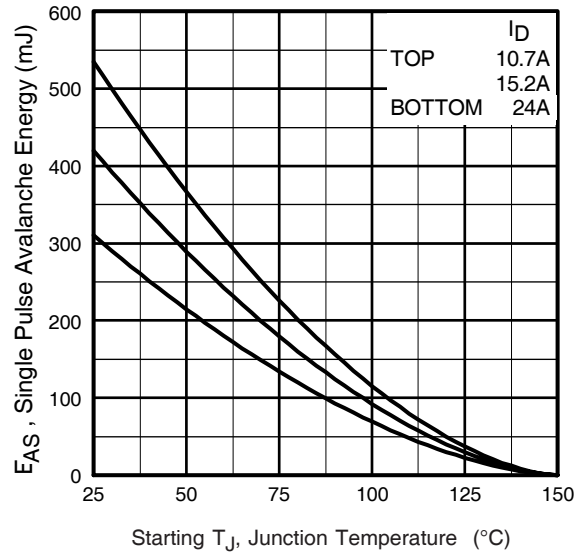

Fig 12c. Maximum Avalanche Energy Vs. Drain Current

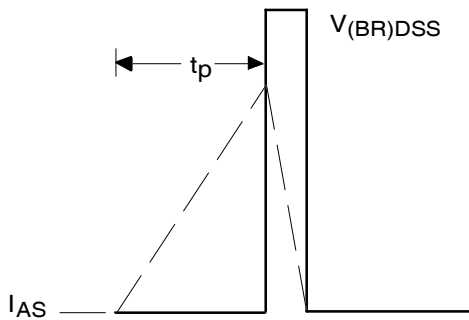

Fig 12b. Unclamped Inductive Waveforms

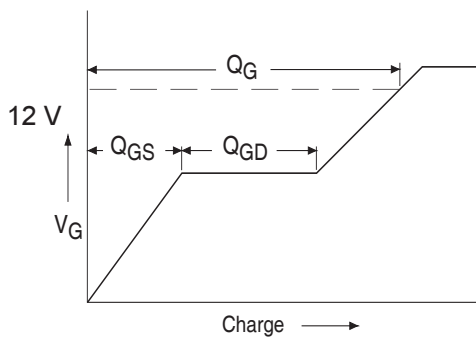

Fig 13a. Basic Gate Charge Waveform

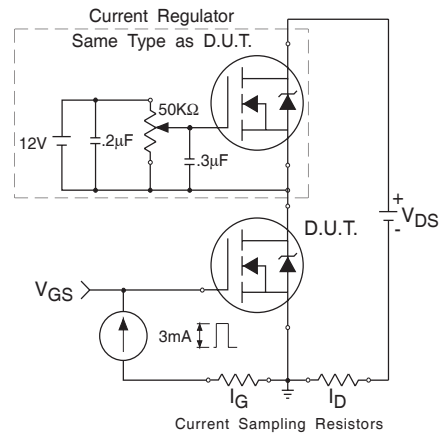
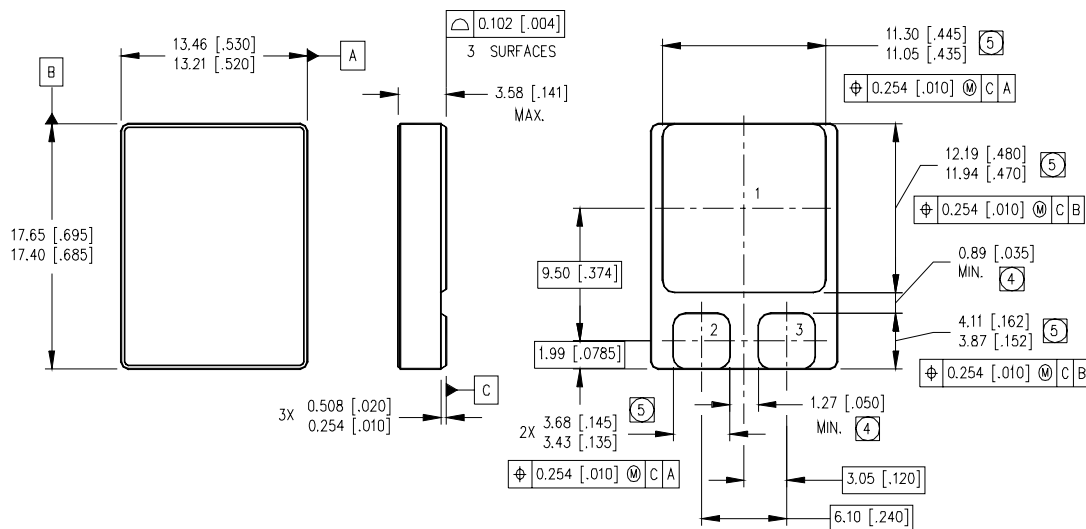

Fig 13b. Gate Charge Test Circuit

**Footnotes:**

- ① Repetitive Rating; Pulse width limited by maximum junction temperature.
- ②  $V_{DD} = 50V$ , starting  $T_J = 25^\circ C$ ,  $L = 1.1mH$   
Peak  $I_L = 24A$ ,  $V_{GS} = 12V$
- ③  $I_{SD} \leq 24A$ ,  $di/dt \leq 120A/\mu s$ ,  
 $V_{DD} \leq 400V$ ,  $T_J \leq 150^\circ C$
- ④ Pulse width  $\leq 300 \mu s$ ; Duty Cycle  $\leq 2\%$
- ⑤ **Total Dose Irradiation with  $V_{GS}$  Bias.**  
12volt  $V_{GS}$  applied and  $V_{DS} = 0$  during irradiation per MIL-STD-750, method 1019, condition A.
- ⑥ **Total Dose Irradiation with  $V_{DS}$  Bias.**  
320volt  $V_{DS}$  applied and  $V_{GS} = 0$  during irradiation per MIL-STD-750, method 1019, condition A.

**Case Outline and Dimensions —SMD-2**



NOTES:

1. DIMENSIONING & TOLERANCING PER ASME Y14.5M-1994.
2. CONTROLLING DIMENSION: INCH.
3. DIMENSIONS ARE SHOWN IN MILLIMETERS [INCHES].
- ④ DIMENSION INCLUDES METALLIZATION FLASH.
- ⑤ DIMENSION DOES NOT INCLUDE METALLIZATION FLASH.

PAD ASSIGNMENTS

- 1 = DRAIN
- 2 = GATE
- 3 = SOURCE

International  
**IR** Rectifier

**IR WORLD HEADQUARTERS:** 233 Kansas St., El Segundo, California 90245, USA Tel: (310) 252-7105  
**IR LEOMINSTER :** 205 Crawford St., Leominster, Massachusetts 01453, USA Tel: (978) 534-5776  
 TAC Fax: (310) 252-7903

Visit us at [www.irf.com](http://www.irf.com) for sales contact information.  
 Data and specifications subject to change without notice. 08/2005