

**SiC**

Silicon Carbide Diode

**5<sup>th</sup> Generation thinQ!™**

650V SiC Schottky Diode

**IDH05G65C5**

**Final Datasheet**

Rev. 2.2, 2012-12-10

**Power Management & Multimarket**

## 5<sup>th</sup> Generation thinQ!<sup>TM</sup> SiC Schottky Diode

IDH05G65C5

### 1 Description

ThinQ!<sup>TM</sup> Generation 5 represents Infineon leading edge technology for the SiC Schottky Barrier diodes. The Infineon proprietary diffusion soldering process, already introduced with G3 is now combined with a new, more compact design and thin-wafer technology. The result is a new family of products showing improved efficiency over all load conditions, resulting from both the improved thermal characteristics and a lower figure of merit ( $Q_c \times V_f$ ).

The new thinQ!<sup>TM</sup> Generation 5 has been designed to complement our 650V CoolMOS<sup>TM</sup> families: this ensures meeting the most stringent application requirements in this voltage range.

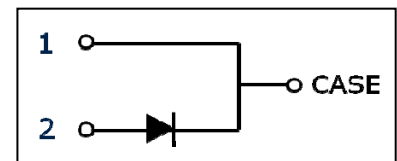
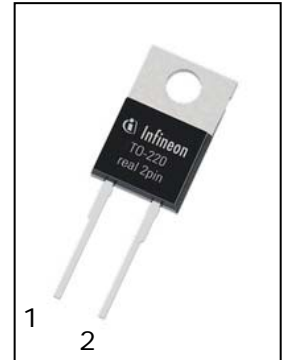

### Features

- Revolutionary semiconductor material - Silicon Carbide
- Benchmark switching behavior
- No reverse recovery/ No forward recovery
- Temperature independent switching behavior
- High surge current capability
- Pb-free lead plating; RoHS compliant
- Qualified according to JEDEC<sup>1)</sup> for target applications
- Breakdown voltage tested at 11 mA<sup>2)</sup>
- Optimized for high temperature operation

### Benefits

- System efficiency improvement over Si diodes
- System cost / size savings due to reduced cooling requirements
- Enabling higher frequency / increased power density solutions
- Higher system reliability due to lower operating temperatures
- Reduced EMI

### Applications

- Switch mode power supply
- Power factor correction
- Solar inverter
- Uninterruptible power supply



**Table 1 Key Performance Parameters**

Parameter	Value	Unit
$V_{DC}$	650	V
$Q_C; V_R=400V$	8	nC
$E_C; V_R=400V$	1.8	$\mu J$
$I_F @ T_C < 145^\circ C$	5	A

**Table 2 Pin Definition**

Pin 1	Pin 2	Pin 3
C	A	n.a.

Type / ordering Code	Package	Marking	Related links
IDH05G65C5	PG-TO220-2	D0565C5	<a href="http://www.infineon.com/sic">www.infineon.com/sic</a>

1) 1 J-STD20 and JESD22

2) All devices tested under avalanche conditions for a time periode of 10ms

## Table of Contents

1	Description.....	2
2	Maximum ratings.....	4
3	Thermal characteristics.....	4
4	Electrical characteristics.....	5
5	Electrical characteristics diagrams.....	6
6	Simplified Forward Characteristics Model .....	8
7	Package outlines .....	9
8	Revision History .....	10

## 2 Maximum ratings

Table 3 Maximum ratings

Parameter	Symbol	Values			Unit	Note/Test Condition
		Min.	Typ.	Max.		
Continuous forward current	$I_F$	–	–	5	A	$T_C < 145^\circ\text{C}$ , $D=1$
Surge non-repetitive forward current, sine halfwave	$I_{F,SM}$	–	–	46		$T_C = 25^\circ\text{C}$ , $t_p=10\text{ ms}$
		–	–	41		$T_C = 150^\circ\text{C}$ , $t_p=10\text{ ms}$
Non-repetitive peak forward current	$I_{F,max}$	–	–	251		$T_C = 25^\circ\text{C}$ , $t_p=10\ \mu\text{s}$
$i^2t$ value	$\int i^2 dt$	–	–	10.4	A <sup>2</sup> s	$T_C = 25^\circ\text{C}$ , $t_p=10\text{ ms}$
		–	–	8.4		$T_C = 150^\circ\text{C}$ , $t_p=10\text{ ms}$
Repetitive peak reverse voltage	$V_{RRM}$	–	–	650	V	$T_j = 25^\circ\text{C}$
Diode dv/dt ruggedness	$dv/dt$	–	–	100	V/ns	$V_R=0..480\text{ V}$
Power dissipation	$P_{tot}$	–	–	55	W	$T_C = 25^\circ\text{C}$
Operating and storage temperature	$T_j; T_{stg}$	-55	–	175	°C	
Mounting torque		–	–	60	Ncm	M2.5 screws

## 3 Thermal characteristics

Table 4 Thermal characteristics TO-220-2

Parameter	Symbol	Values			Unit	Note/Test Condition
		Min.	Typ.	Max.		
Thermal resistance, junction-case	$R_{thJC}$	–	1.7	2.7	K/W	leaded
Thermal resistance, junction-ambient	$R_{thJA}$	–	–	62		
Soldering temperature, wavesoldering only allowed at leads	$T_{sold}$	–	–	260	°C	1.6mm (0.063 in.) from case for 10 s

## 4 Electrical characteristics

**Table 5 Static characteristics**

Parameter	Symbol	Values			Unit	Note/Test Condition
		Min.	Typ.	Max.		
DC blocking voltage	$V_{DC}$	650	–	–	V	$I_R = 0.09 \text{ mA}, T_j = 25^\circ\text{C}$
Diode forward voltage	$V_F$	–	1.5	1.7		$I_F = 5 \text{ A}, T_j = 25^\circ\text{C}$
		–	1.8	2.1		$I_F = 5 \text{ A}, T_j = 150^\circ\text{C}$
Reverse current	$I_R$	–	0.3	90	$\mu\text{A}$	$V_R = 650 \text{ V}, T_j = 25^\circ\text{C}$
		–	0.06	30		$V_R = 600 \text{ V}, T_j = 25^\circ\text{C}$
		–	1	600		$V_R = 650 \text{ V}, T_j = 150^\circ\text{C}$

**Table 6 AC characteristics**

Parameter	Symbol	Values			Unit	Note/Test Condition
		Min.	Typ.	Max.		
Total capacitive charge	$Q_c$	–	8	–	nC	$V_R = 400 \text{ V}, di/dt = 200 \text{ A}/\mu\text{s}, I_F \leq I_{F,MAX}, T_j = 150^\circ\text{C}.$
Total Capacitance	C	–	160	–	pF	$V_R = 1 \text{ V}, f = 1 \text{ MHz}$
		–	20	–		$V_R = 300 \text{ V}, f = 1 \text{ MHz}$
		–	20	–		$V_R = 600 \text{ V}, f = 1 \text{ MHz}$

## 5 Electrical characteristics diagrams

Table 7

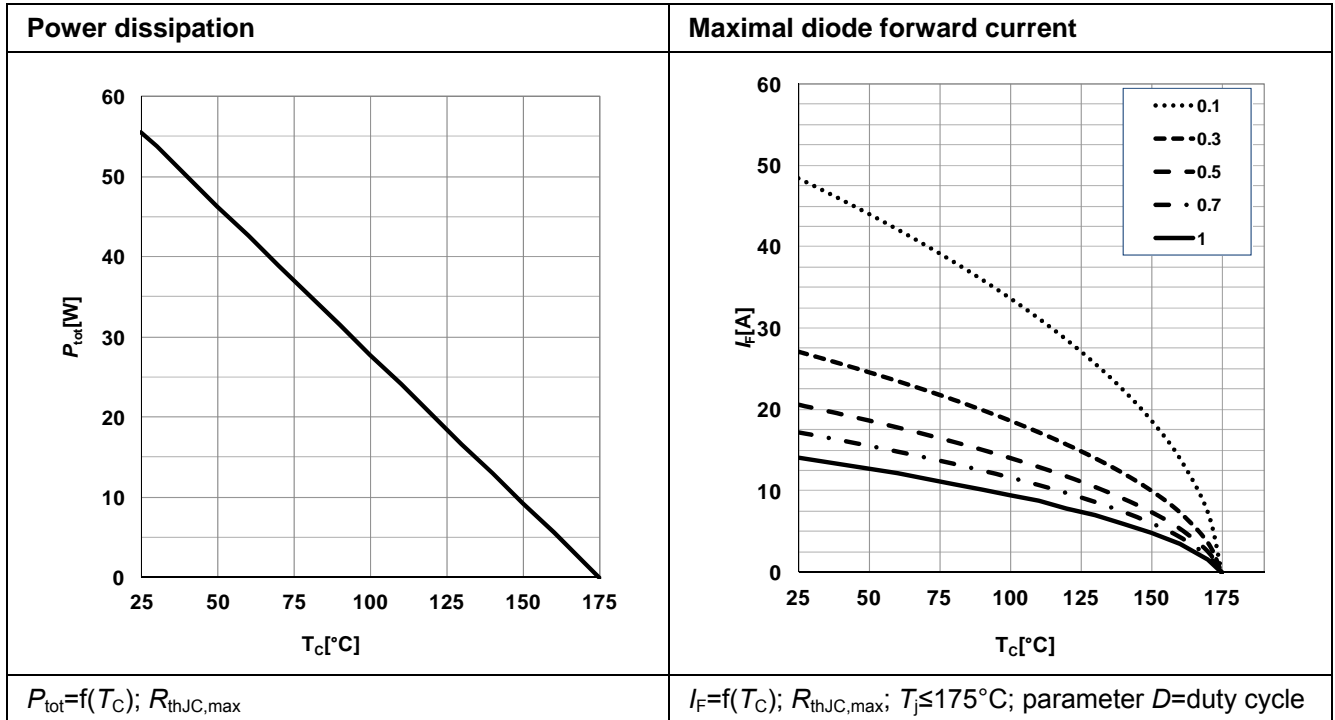
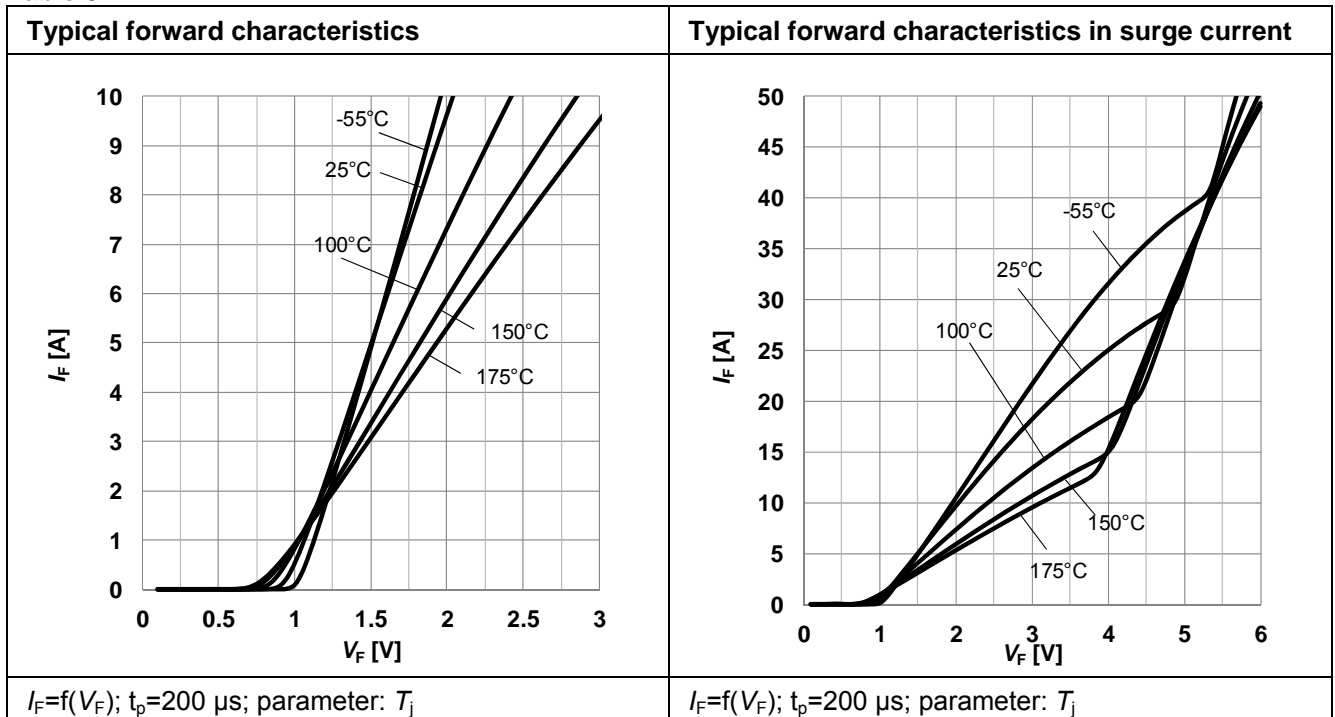
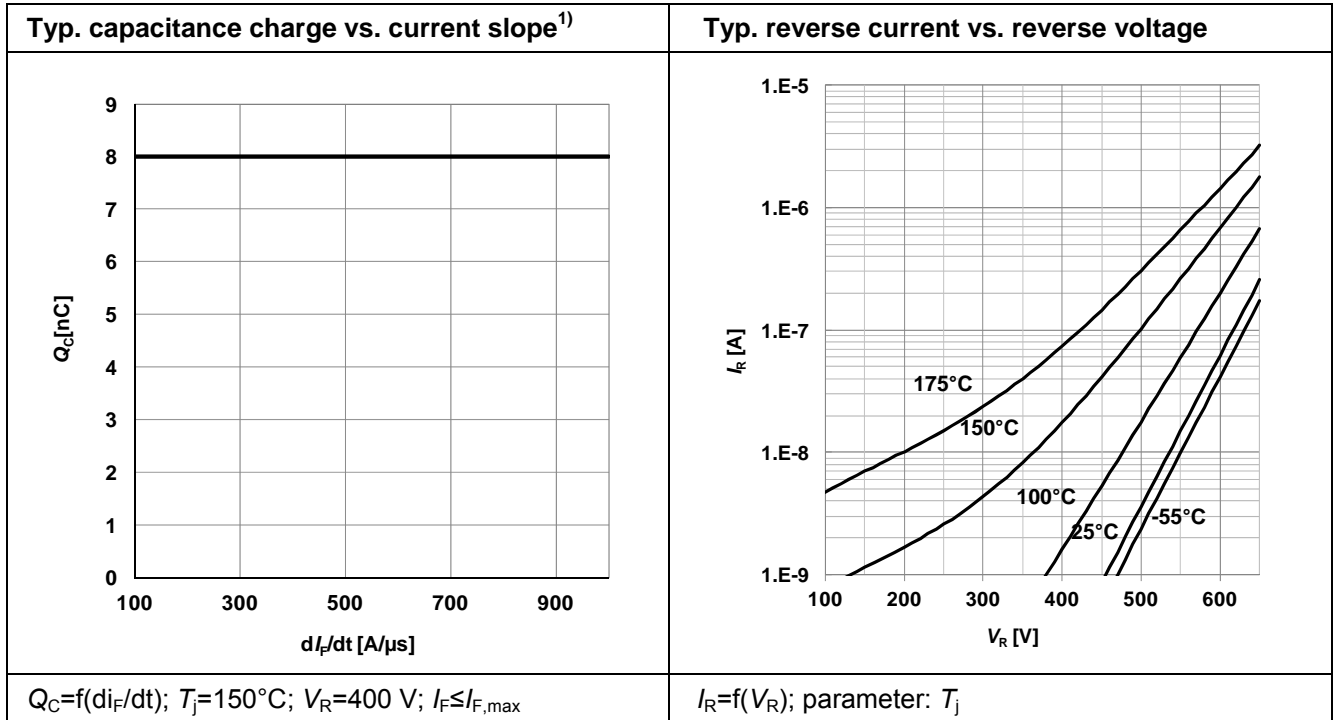

Table 8



Electrical characteristics diagrams

Table 9



1) Only capacitive charge, guaranteed by design.

Table 10

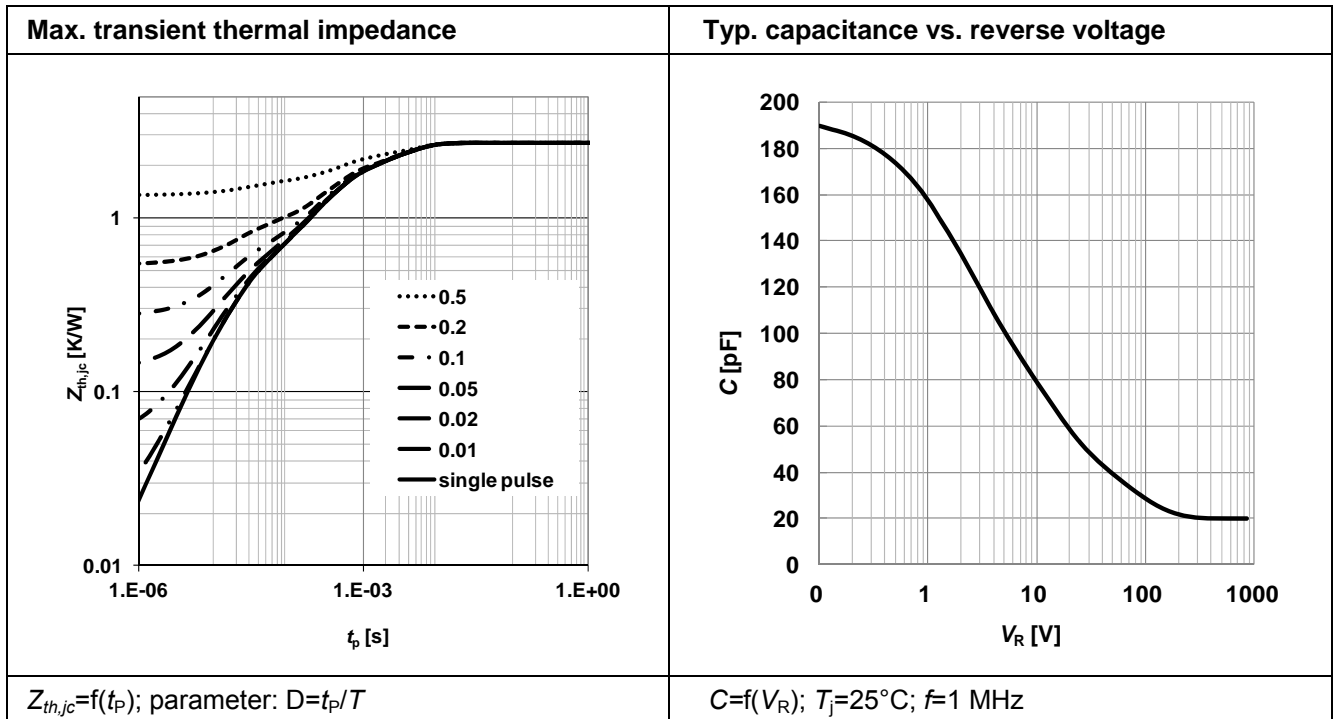
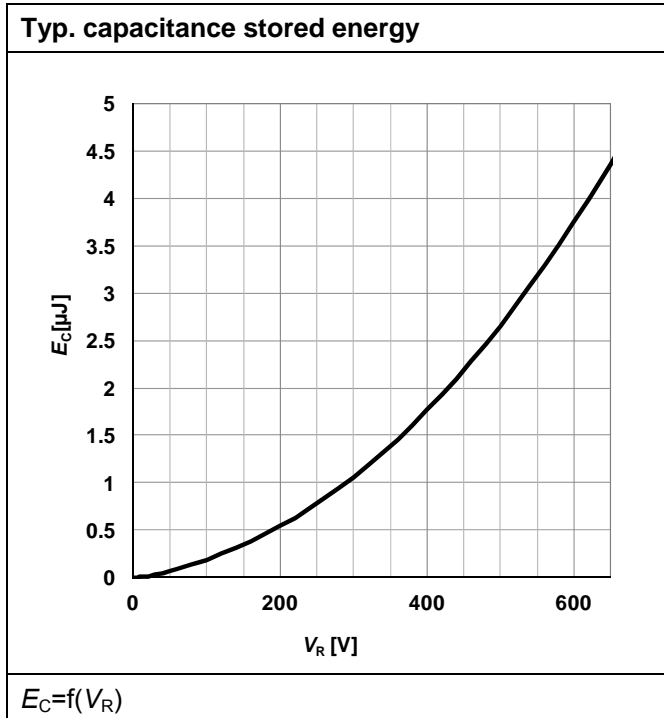

Table 11



## 6 Simplified Forward Characteristics Model

Table 12

Equivalent forward current curve	Mathematical Equation
	$V_F = V_{TH} + R_{DIFF} \cdot I_F$ $V_{TH}(T_j) = -0.001 \cdot T_j + 1.04 \text{ [V]}$ $R_{DIFF}(T_j) = 2.57 \cdot 10^{-6} \cdot T_j^2 + 2.57 \cdot 10^{-4} \cdot T_j + 0.093 \text{ [\Omega]}$
$V_F = f(I_F)$	$T_j$ in °C; $-55^\circ\text{C} < T_j < 175^\circ\text{C}$ ; $I_F < 10 \text{ A}$



7 Package outlines

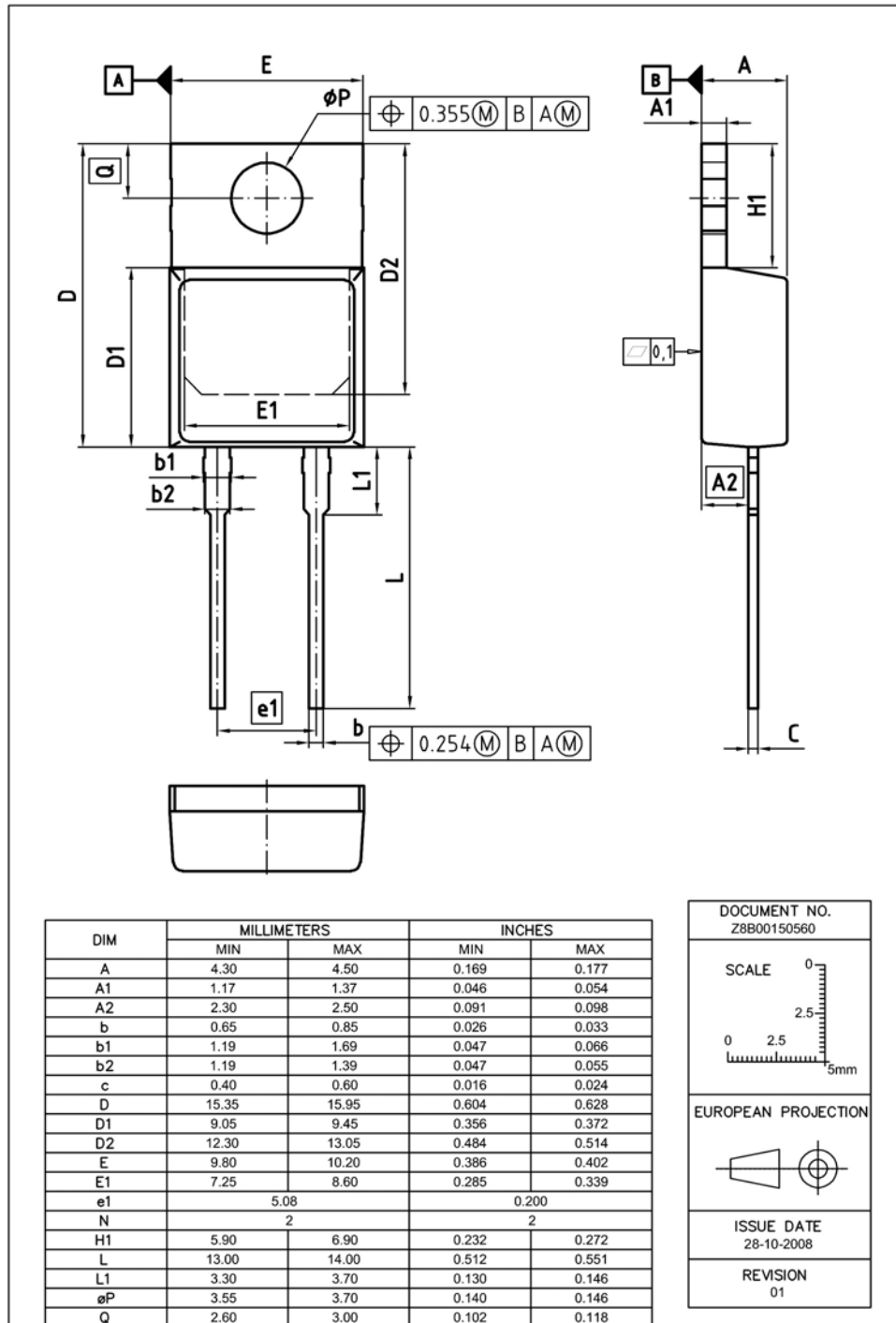

Figure 1 Outlines TO-220, dimensions in mm/inches

## 8 Revision History

### 5<sup>th</sup> Generation thinQ!<sup>TM</sup> SiC Schottky Diode

#### Revision History: 2012-12-10, Rev. 2.2

##### Previous Revision:

Revision	Subjects (major changes since last version)
2.0	Release of the final datasheet.
2.1	Reverse current values, maximum diode forward voltage.
2.2	Reverse current values, tested avalanche current, simplified calculation model

#### We Listen to Your Comments

Any information within this document that you feel is wrong, unclear or missing at all?  
Your feedback will help us to continuously improve the quality of this document.

Please send your proposal (including a reference to this document) to: [erratum@infineon.com](mailto:erratum@infineon.com)

Edition 2012-12-10

Published by

Infineon Technologies AG

81726 Munich, Germany

© 2012 Infineon Technologies AG

All Rights Reserved.



#### Legal Disclaimer

The information given in this document shall in no event be regarded as a guarantee of conditions or characteristics. With respect to any examples or hints given herein, any typical values stated herein and/or any information regarding the application of the device, Infineon Technologies hereby disclaims any and all warranties and liabilities of any kind, including without limitation, warranties of non-infringement of intellectual property rights of any third party.

#### Information

For further information on technology, delivery terms and conditions and prices, please contact the nearest Infineon Technologies Office ([www.infineon.com](http://www.infineon.com)).

#### Warnings

Due to technical requirements, components may contain dangerous substances. For information on the types in question, please contact the nearest Infineon Technologies Office.

The Infineon Technologies component described in this Data Sheet may be used in life-support devices or systems and/or automotive, aviation and aerospace applications or systems only with the express written approval of Infineon Technologies, if a failure of such components can reasonably be expected to cause the failure of that life-support, automotive, aviation and aerospace device or system or to affect the safety or effectiveness of that device or system. Life support devices or systems are intended to be implanted in the human body or to support and/or maintain and sustain and/or protect human life. If they fail, it is reasonable to assume that the health of the user or other persons may be endangered.

www.infineon.com

Published by Infineon Technologies AG