

Cool MOS™ Power Transistor
Feature

- New revolutionary high voltage technology
- Ultra low gate charge
- Periodic avalanche rated
- Extreme dv/dt rated
- Ultra low effective capacitances
- Pb-free lead plating; RoHS compliant
- Qualified according to JEDEC⁰⁾ for target applications

$V_{DS} @ T_{jmax}$	650	V
$R_{DS(on)}$	3	Ω
I_D	1.8	A

PG-TO220

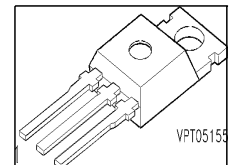

Type	Package	Ordering Code	Marking
SPP02N60C3	PG-TO220	Q67040-S4392	02N60C3

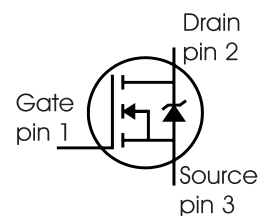
Maximum Ratings

Parameter	Symbol	Value	Unit
Continuous drain current $T_C = 25\text{ }^\circ\text{C}$ $T_C = 100\text{ }^\circ\text{C}$	I_D	1.8 1.1	A
Pulsed drain current, t_p limited by T_{jmax}	$I_{D\text{ puls}}$	5.4	
Avalanche energy, single pulse $I_D = 1.35\text{ A}$, $V_{DD} = 50\text{ V}$	E_{AS}	50	mJ
Avalanche energy, repetitive t_{AR} limited by T_{jmax} ¹⁾ $I_D = 1.8\text{ A}$, $V_{DD} = 50\text{ V}$	E_{AR}	0.07	
Avalanche current, repetitive t_{AR} limited by T_{jmax}	I_{AR}	1.8	A
Gate source voltage static	V_{GS}	± 20	V
Gate source voltage AC ($f > 1\text{ Hz}$)	V_{GS}	± 30	
Power dissipation, $T_C = 25\text{ }^\circ\text{C}$	P_{tot}	25	W
Operating and storage temperature	T_j, T_{stg}	-55... +150	$^\circ\text{C}$
Reverse diode dv/dt ⁶⁾	dv/dt	15	V/ns

Maximum Ratings

Parameter	Symbol	Value	Unit
Drain Source voltage slope $V_{DS} = 480\text{ V}, I_D = 1.8\text{ A}, T_j = 125\text{ }^\circ\text{C}$	dv/dt	50	V/ns

Thermal Characteristics

Parameter	Symbol	Values			Unit
		min.	typ.	max.	
Thermal resistance, junction - case	R_{thJC}	-	-	5	K/W
Thermal resistance, junction - ambient, leaded	R_{thJA}	-	-	62	
SMD version, device on PCB: @ min. footprint @ 6 cm ² cooling area ²⁾	R_{thJA}	-	-	62	
Soldering temperature, wavesoldering 1.6 mm (0.063 in.) from case for 10s ³⁾	T_{sold}	-	-	260	°C

Electrical Characteristics, at $T_j=25^\circ\text{C}$ unless otherwise specified

Parameter	Symbol	Conditions	Values			Unit
			min.	typ.	max.	
Drain-source breakdown voltage	$V_{(BR)DSS}$	$V_{GS}=0\text{V}, I_D=0.25\text{mA}$	600	-	-	V
Drain-Source avalanche breakdown voltage	$V_{(BR)DS}$	$V_{GS}=0\text{V}, I_D=0.25\text{A}$	-	700	-	
Gate threshold voltage	$V_{GS(th)}$	$I_D=80\mu\text{A}, V_{GS}=V_{DS}$	2.1	3	3.9	
Zero gate voltage drain current	I_{DSS}	$V_{DS}=600\text{V}, V_{GS}=0\text{V},$ $T_j=25^\circ\text{C},$ $T_j=150^\circ\text{C}$	-	0.5	1	μA
Gate-source leakage current	I_{GSS}	$V_{GS}=30\text{V}, V_{DS}=0\text{V}$	-	-	100	
Drain-source on-state resistance	$R_{DS(on)}$	$V_{GS}=10\text{V}, I_D=1.1\text{A},$ $T_j=25^\circ\text{C}$ $T_j=150^\circ\text{C}$	-	2.7	3	Ω
Gate input resistance	R_G	$f=1\text{MHz}, \text{open Drain}$	-	9	-	

Electrical Characteristics , at $T_j = 25\text{ }^\circ\text{C}$, unless otherwise specified

Parameter	Symbol	Conditions	Values			Unit
			min.	typ.	max.	
Transconductance	g_{fs}	$V_{DS} \geq 2 \cdot I_D \cdot R_{DS(on)max}$, $I_D = 1.1\text{A}$	-	1.75	-	S
Input capacitance	C_{iss}	$V_{GS} = 0\text{V}$, $V_{DS} = 25\text{V}$, $f = 1\text{MHz}$	-	200	-	pF
Output capacitance	C_{oss}		-	90	-	
Reverse transfer capacitance	C_{rss}		-	4	-	
Effective output capacitance, ⁴⁾ energy related	$C_{o(er)}$	$V_{GS} = 0\text{V}$, $V_{DS} = 0\text{V to } 480\text{V}$	-	8.1	-	pF
Effective output capacitance, ⁵⁾ time related	$C_{o(tr)}$		-	15.7	-	
Turn-on delay time	$t_{d(on)}$	$V_{DD} = 350\text{V}$, $V_{GS} = 0/10\text{V}$, $I_D = 1.8\text{A}$, $R_G = 50\Omega$	-	6	-	ns
Rise time	t_r		-	3	-	
Turn-off delay time	$t_{d(off)}$		-	68	70	
Fall time	t_f		-	12	30	

Gate Charge Characteristics

Gate to source charge	Q_{gs}	$V_{DD} = 420\text{V}$, $I_D = 1.8\text{A}$	-	1.6	-	nC
Gate to drain charge	Q_{gd}		-	3.8	-	
Gate charge total	Q_g	$V_{DD} = 420\text{V}$, $I_D = 1.8\text{A}$, $V_{GS} = 0\text{ to } 10\text{V}$	-	9.5	12.5	
Gate plateau voltage	$V_{(plateau)}$	$V_{DD} = 420\text{V}$, $I_D = 1.8\text{A}$	-	5.5	-	V

⁰J-STD20 and JESD22

¹Repetitive avalanche causes additional power losses that can be calculated as $P_{AV} = E_{AR} \cdot f$.

²Device on 40mm*40mm*1.5mm epoxy PCB FR4 with 6cm² (one layer, 70 μm thick) copper area for drain connection. PCB is vertical without blown air.

³Soldering temperature for TO-263: 220°C, reflow

⁴ $C_{o(er)}$ is a fixed capacitance that gives the same stored energy as C_{oss} while V_{DS} is rising from 0 to 80% V_{DSS} .

⁵ $C_{o(tr)}$ is a fixed capacitance that gives the same charging time as C_{oss} while V_{DS} is rising from 0 to 80% V_{DSS} .

⁶ $I_{SD} \leq I_D$, $di/dt \leq 400\text{A/us}$, $V_{DClink} = 400\text{V}$, $V_{peak} < V_{BR, DSS}$, $T_j < T_{j,max}$.

Identical low-side and high-side switch.

Electrical Characteristics, at $T_j = 25\text{ }^\circ\text{C}$, unless otherwise specified

Parameter	Symbol	Conditions	Values			Unit
			min.	typ.	max.	
Inverse diode continuous forward current	I_S	$T_C=25^\circ\text{C}$	-	-	1.8	A
Inverse diode direct current, pulsed	I_{SM}		-	-	5.4	
Inverse diode forward voltage	V_{SD}	$V_{GS}=0\text{V}, I_F=I_S$	-	1	1.2	V
Reverse recovery time	t_{rr}	$V_R=420\text{V}, I_F=I_S,$	-	200	350	ns
Reverse recovery charge	Q_{rr}	$di_F/dt=100\text{A}/\mu\text{s}$	-	1.3	-	μC
Peak reverse recovery current	I_{rrm}		-	9	-	A
Peak rate of fall of reverse recovery current	di_{rr}/dt		-	-	200	$\text{A}/\mu\text{s}$

Typical Transient Thermal Characteristics

Symbol	Value	Unit	Symbol	Value	Unit
	typ.			typ.	
Thermal resistance			Thermal capacitance		
R_{th1}	0.1	K/W	C_{th1}	0.00002806	Ws/K
R_{th2}	0.184		C_{th2}	0.0001113	
R_{th3}	0.306		C_{th3}	0.0001679	
R_{th4}	1.207		C_{th4}	0.000547	
R_{th5}	0.974		C_{th5}	0.001388	
R_{th6}	0.251		C_{th6}	0.035	

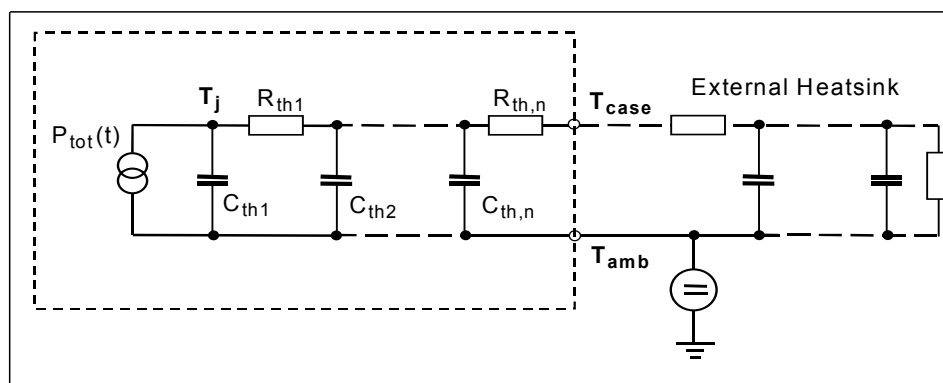

1 Power dissipation

$$P_{tot} = f(T_C)$$

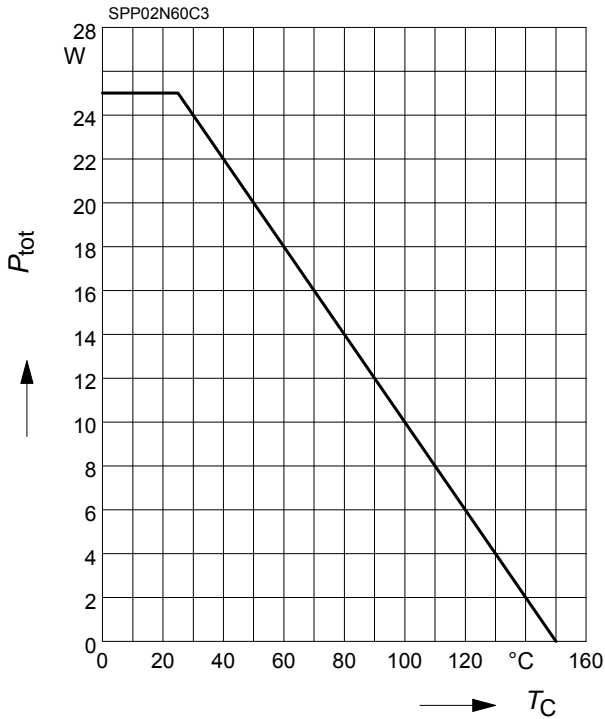

2 Safe operating area

$$I_D = f(V_{DS})$$

parameter : $D = 0$, $T_C = 25^\circ\text{C}$

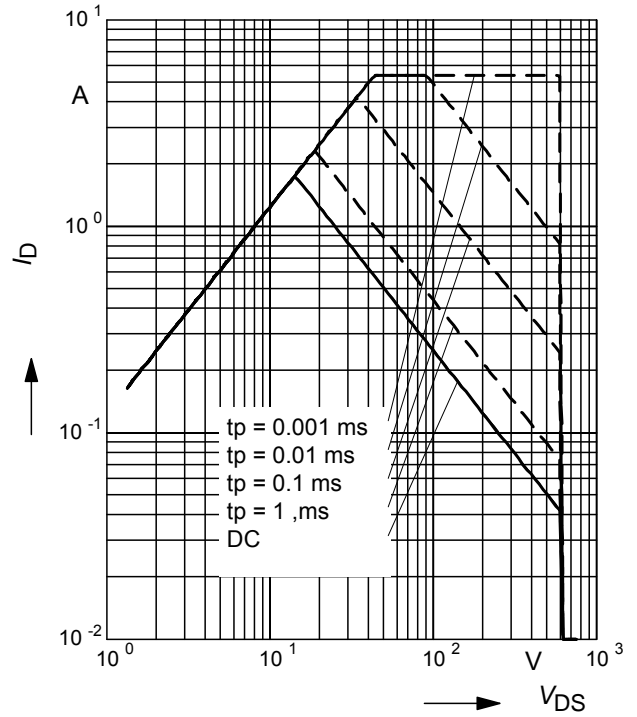

3 Transient thermal impedance

$$Z_{thJC} = f(t_p)$$

parameter: $D = t_p/T$

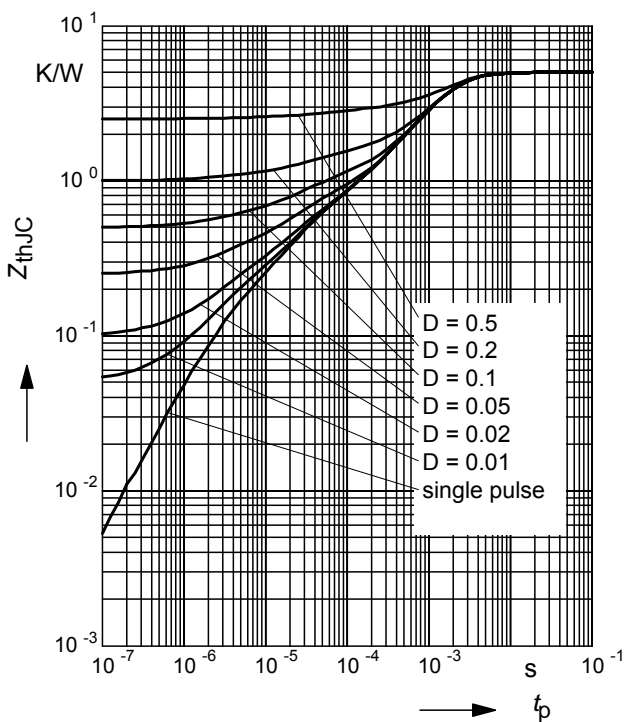

4 Typ. output characteristic

$$I_D = f(V_{DS}); T_j = 25^\circ\text{C}$$

parameter: $t_p = 10 \mu\text{s}$, V_{GS}

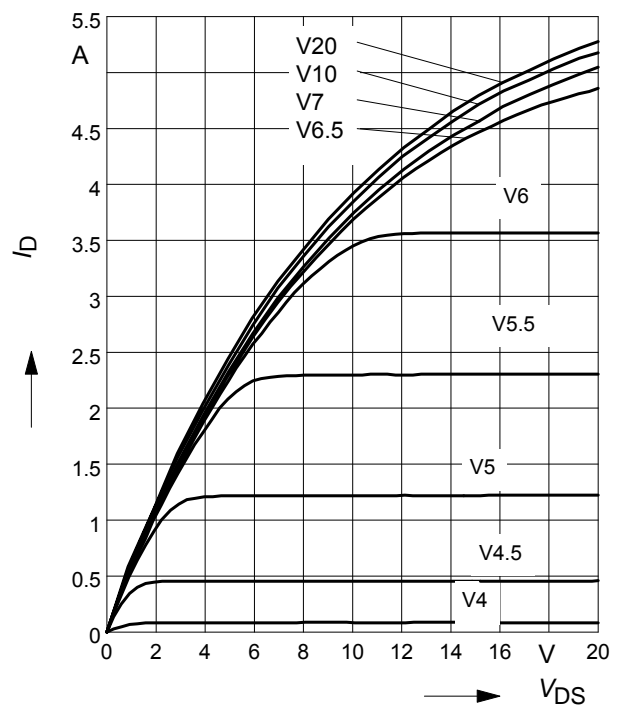

5 Typ. output characteristic

$I_D = f(V_{DS}); T_j = 150^\circ\text{C}$

parameter: $t_p = 10 \mu\text{s}, V_{GS}$

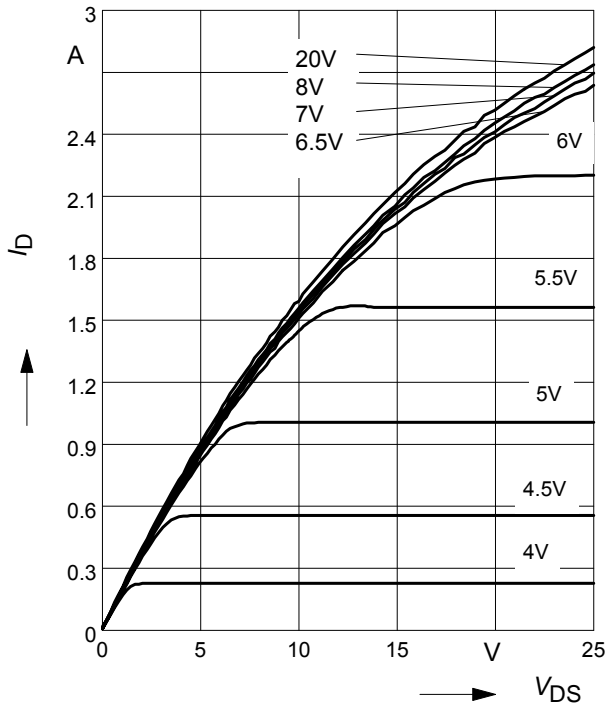

6 Typ. drain-source on resistance

$R_{DS(on)} = f(I_D)$

parameter: $T_j = 150^\circ\text{C}, V_{GS}$

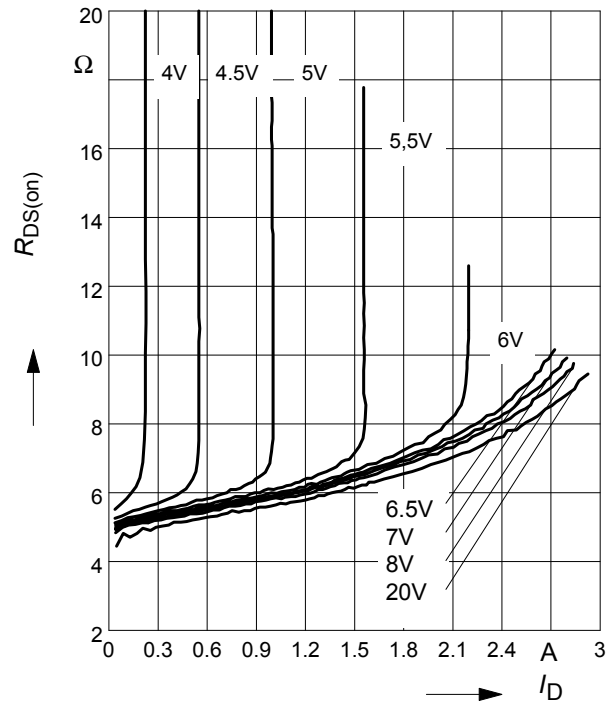

7 Drain-source on-state resistance

$R_{DS(on)} = f(T_j)$

parameter: $I_D = 1.1 \text{ A}, V_{GS} = 10 \text{ V}$

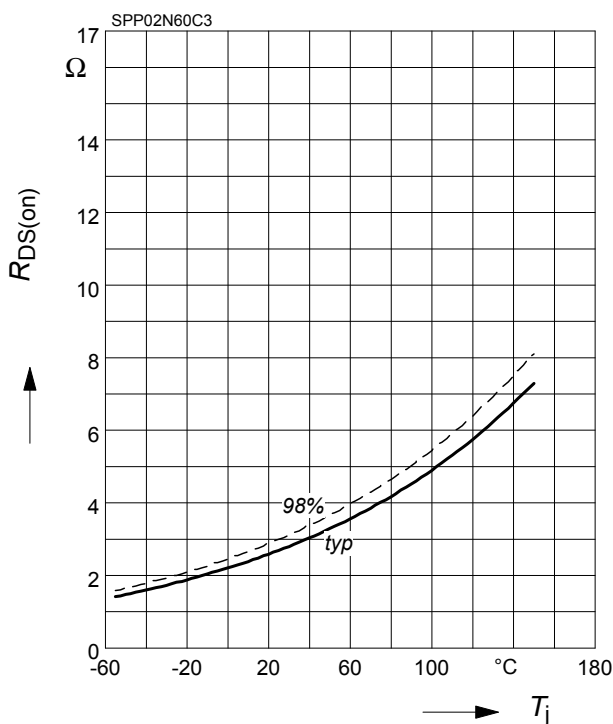

8 Typ. transfer characteristics

$I_D = f(V_{GS}); V_{DS} \geq 2 \times I_D \times R_{DS(on)max}$

parameter: $t_p = 10 \mu\text{s}$

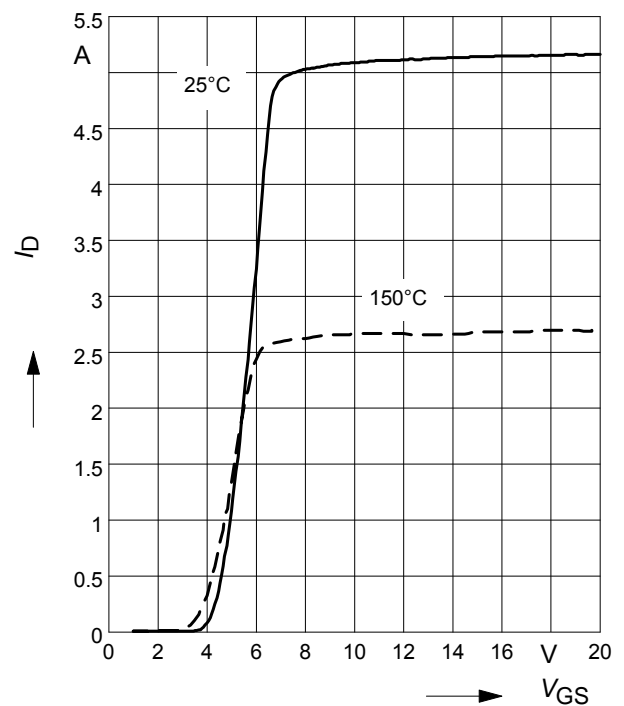

9 Typ. gate charge

$V_{GS} = f(Q_{Gate})$

parameter: $I_D = 1.8$ A pulsed

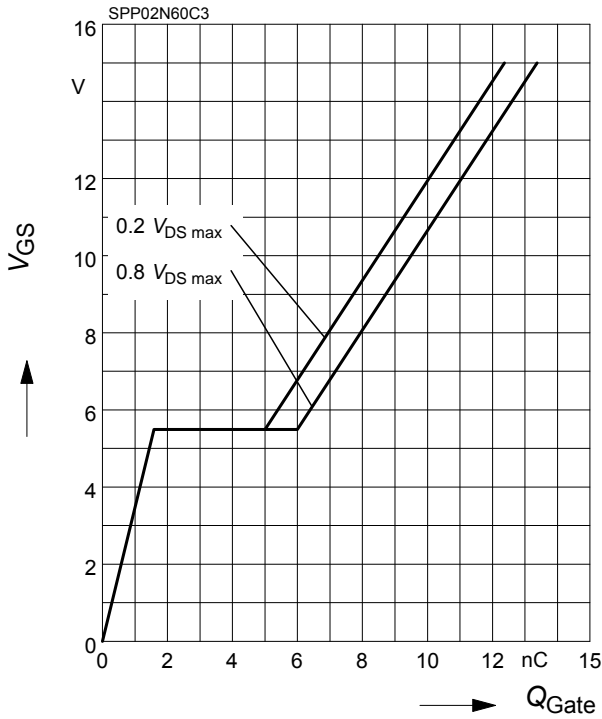

10 Forward characteristics of body diode

$I_F = f(V_{SD})$

parameter: $T_j, t_p = 10 \mu s$

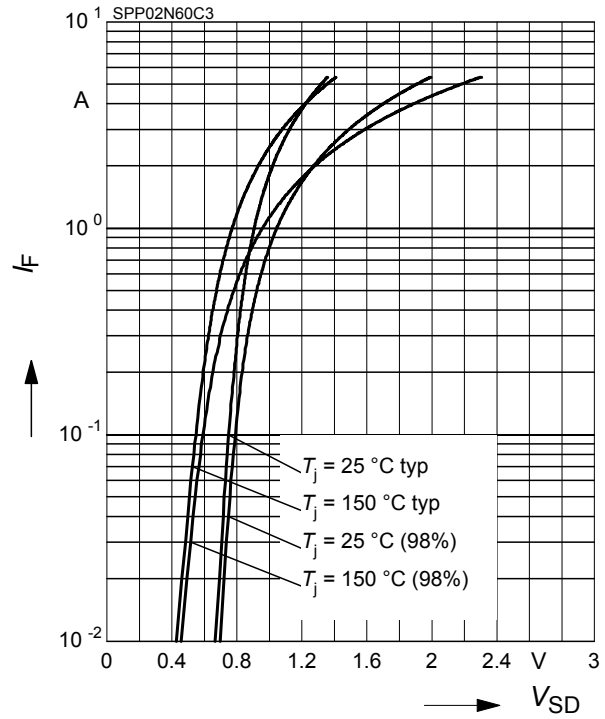

11 Typ. drain current slope

$di/dt = f(R_G)$, inductive load, $T_j = 125^\circ C$

par.: $V_{DS} = 380V, V_{GS} = 0/+13V, I_D = 1.8A$

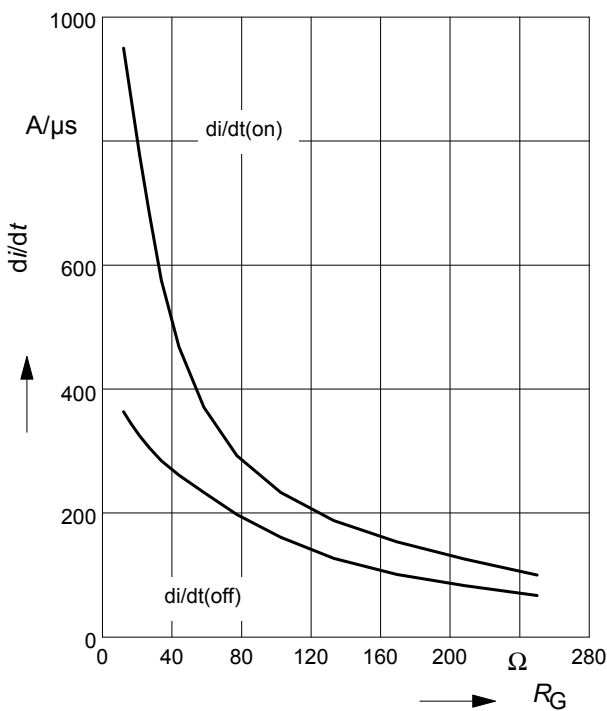

12 Typ. switching time

$t = f(R_G)$, inductive load, $T_j = 125^\circ C$

par.: $V_{DS} = 380V, V_{GS} = 0/+13V, I_D = 1.8$ A

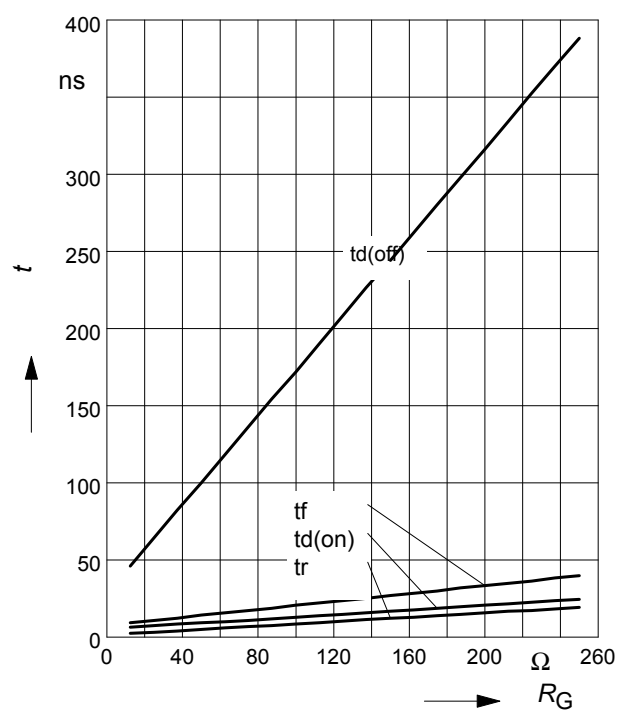

13 Typ. switching time

$t = f(I_D)$, inductive load, $T_j=125^\circ\text{C}$
 par.: $V_{DS}=380\text{V}$, $V_{GS}=0/+13\text{V}$, $R_G=50\Omega$

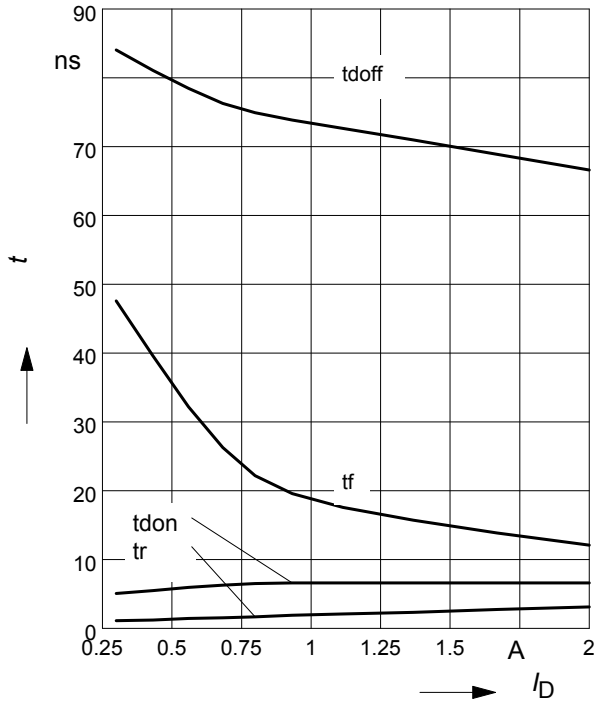

14 Typ. drain source voltage slope

$dv/dt = f(R_G)$, inductive load, $T_j = 125^\circ\text{C}$
 par.: $V_{DS}=380\text{V}$, $V_{GS}=0/+13\text{V}$, $I_D=1.8\text{A}$

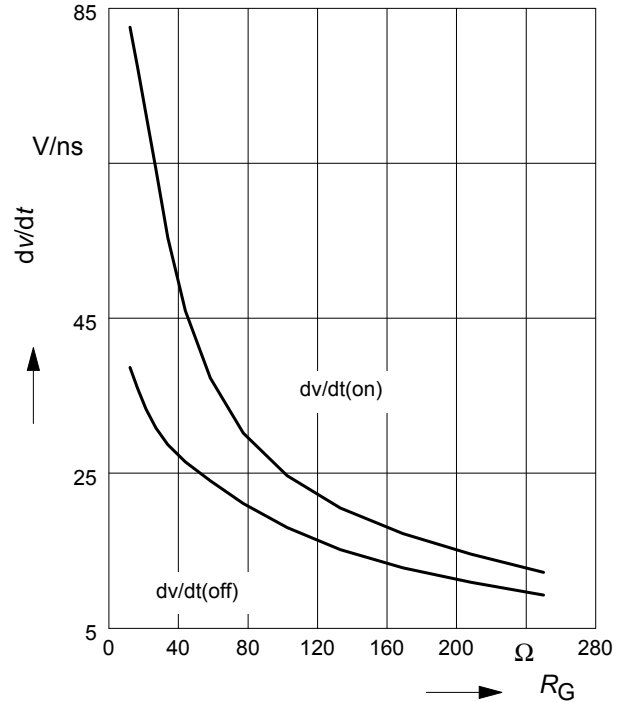

15 Typ. switching losses

$E = f(I_D)$, inductive load, $T_j=125^\circ\text{C}$
 par.: $V_{DS}=380\text{V}$, $V_{GS}=0/+13\text{V}$, $R_G=50\Omega$

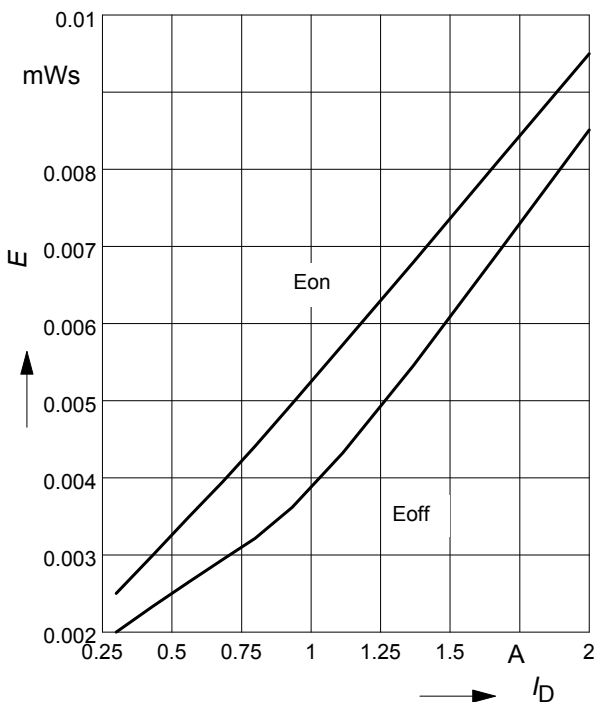

16 Typ. switching losses

$E = f(R_G)$, inductive load, $T_j=125^\circ\text{C}$
 par.: $V_{DS}=380\text{V}$, $V_{GS}=0/+13\text{V}$, $I_D=1.8\text{A}$

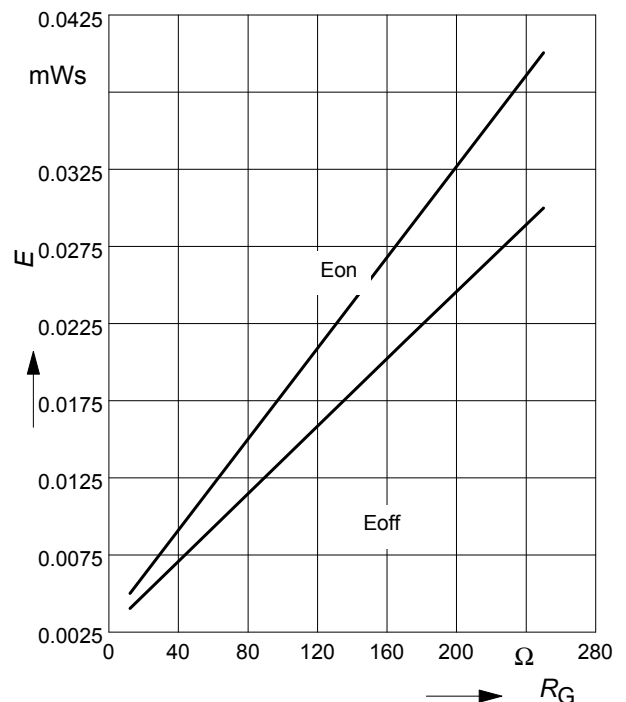

17 Avalanche SOA

$I_{AR} = f(t_{AR})$

par.: $T_j \leq 150\text{ }^\circ\text{C}$

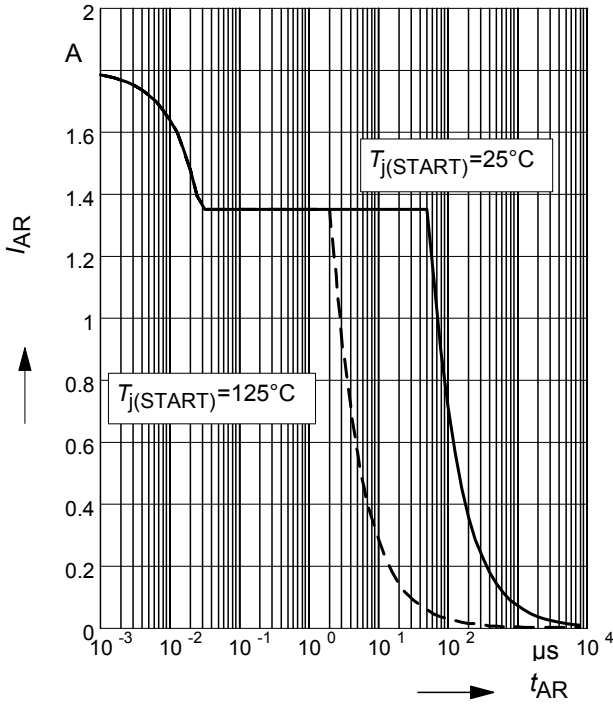

18 Avalanche energy

$E_{AS} = f(T_j)$

par.: $I_D = 1.35\text{ A}$, $V_{DD} = 50\text{ V}$

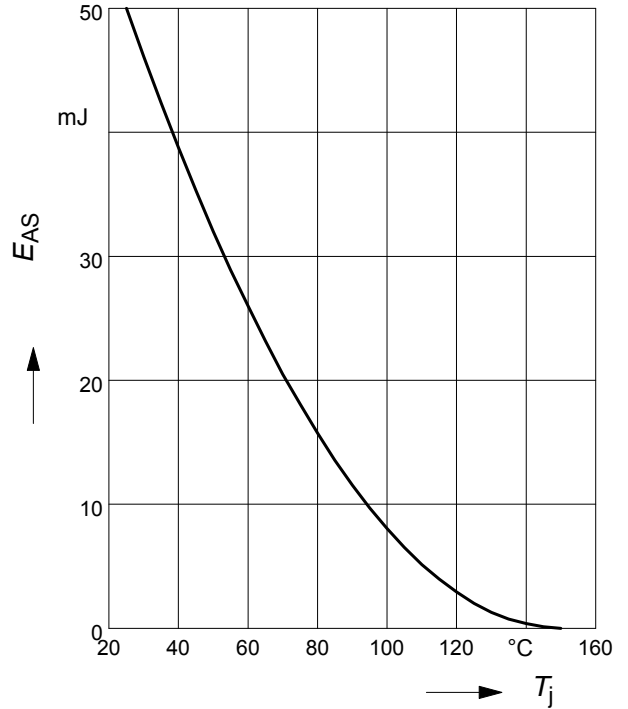

19 Drain-source breakdown voltage

$V_{(BR)DSS} = f(T_j)$

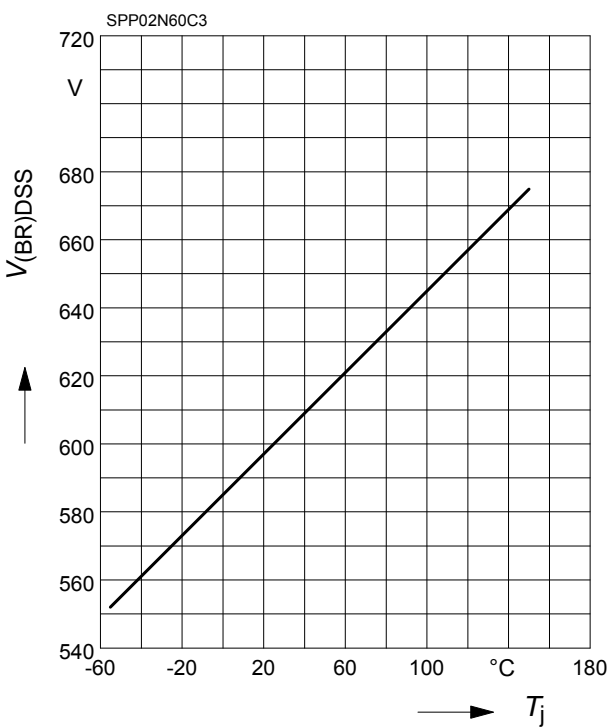

20 Avalanche power losses

$P_{AR} = f(f)$

parameter: $E_{AR} = 0.07\text{ mJ}$

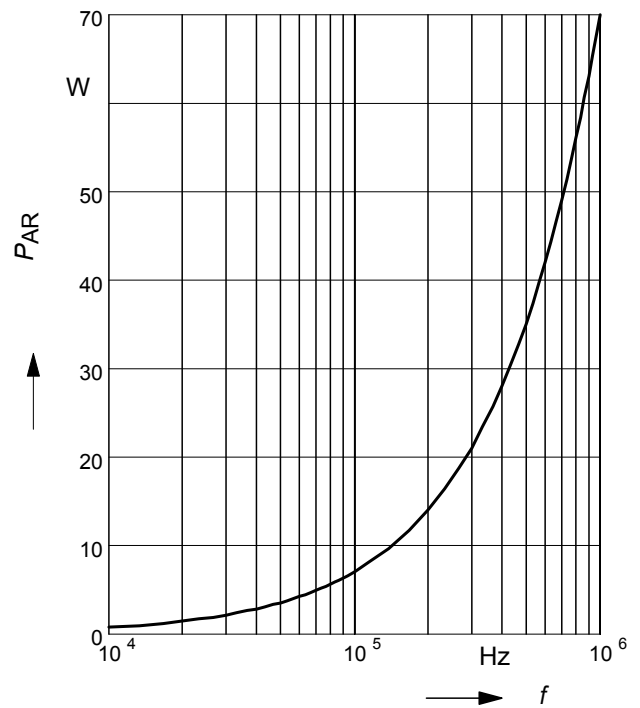

21 Typ. capacitances

$$C = f(V_{DS})$$

parameter: $V_{GS}=0V, f=1\text{ MHz}$

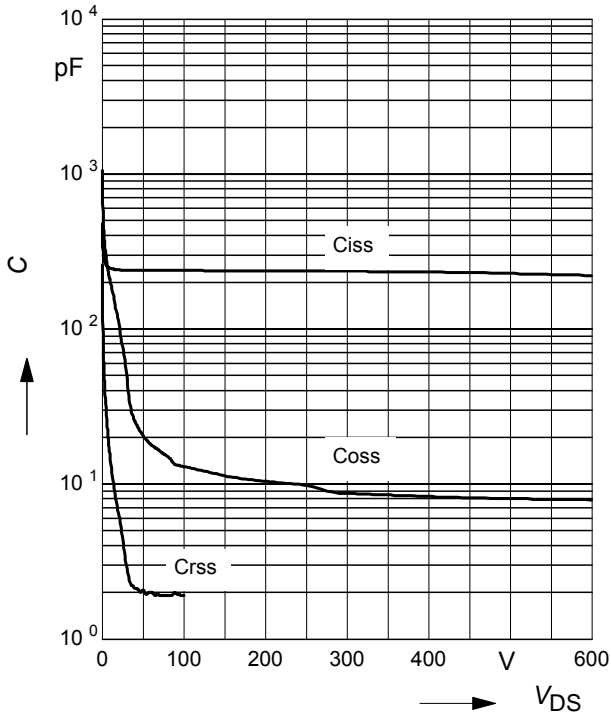

22 Typ. C_{OSS} stored energy

$$E_{Oss} = f(V_{DS})$$

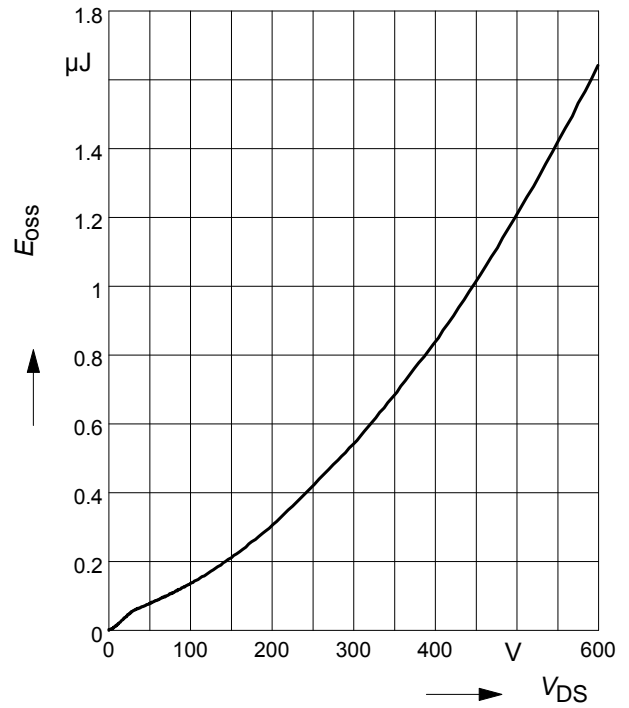

Definition of diodes switching characteristics

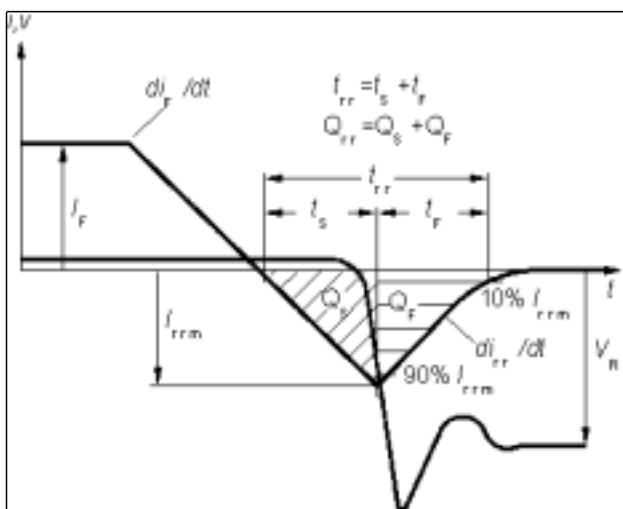

PG-TO220-3-1, PG-TO220-3-21 : Outline

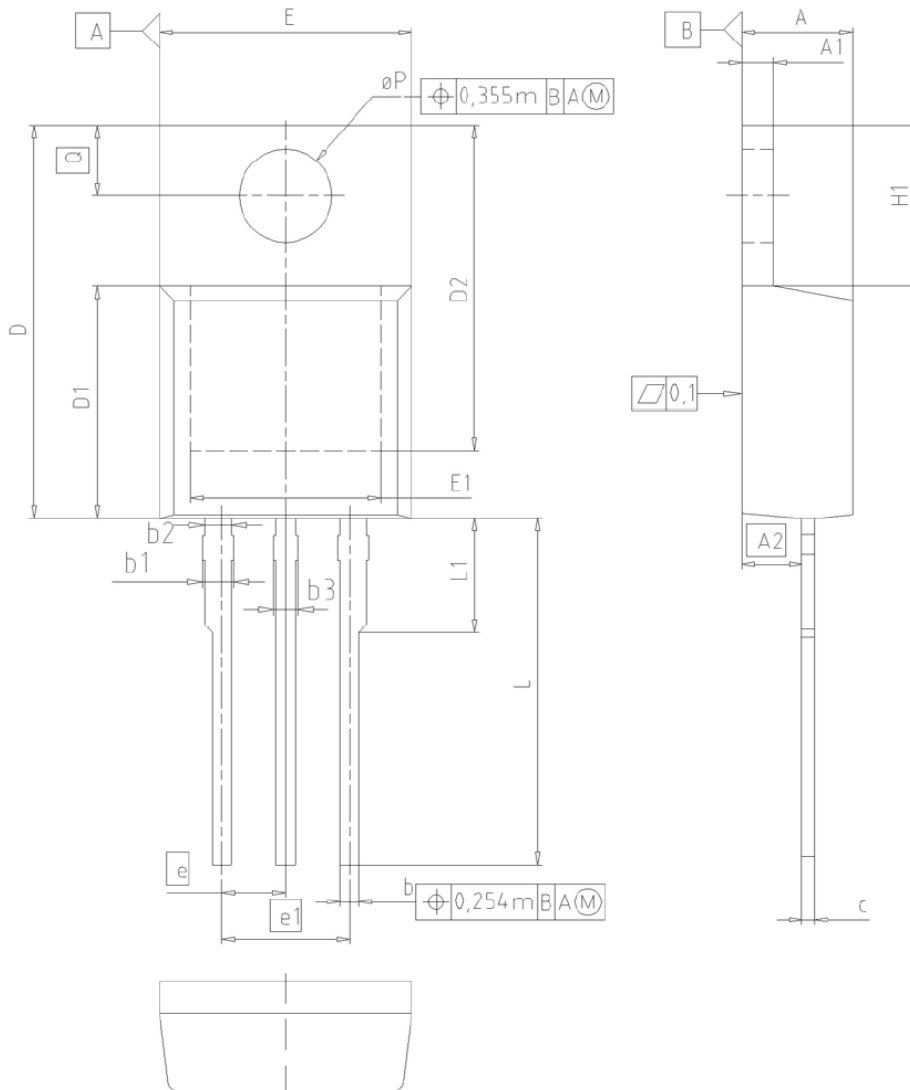

DIM	MILLIMETERS		INCHES	
	MIN	MAX	MIN	MAX
A	4.30	4.57	0.169	0.180
A1	1.17	1.40	0.046	0.055
A2	2.15	2.72	0.085	0.107
b	0.65	0.86	0.026	0.034
b1	0.95	1.40	0.037	0.055
b2	0.95	1.15	0.037	0.045
b3	0.65	1.15	0.026	0.045
c	0.33	0.60	0.013	0.024
D	14.81	15.95	0.583	0.628
D1	8.51	9.45	0.335	0.372
D2	12.19	13.10	0.480	0.516
E	9.70	10.36	0.382	0.408
E1	6.50	8.60	0.256	0.339
e	2.54		0.100	
e1	5.08		0.200	
N	3		3	
H1	5.90	6.90	0.232	0.272
L	13.00	14.00	0.512	0.551
L1	-	4.80	-	0.189
øP	3.60	3.89	0.142	0.153
Q	2.60	3.00	0.102	0.118

DOCUMENT NO.
Z8B00003318

SCALE

EUROPEAN PROJECTION

ISSUE DATE
23-08-2007

REVISION
05

600V CoolMOS™ C3 Power Transistor

SPP02N60C3

Revision History

SPP02N60C3

Revision: 2017-05-18, Rev. 2.8

Previous Revision

Revision	Date	Subjects (major changes since last revision)
2.8	2017-05-18	typo correction in dv/dt diagram scaling

Trademarks of Infineon Technologies AG

AURIX™, C166™, CanPAK™, CIPOS™, CoolGaN™, CoolMOS™, CoolSET™, CoolSiC™, CORECONTROL™, CROSSAVE™, DAVE™, DI-POL™, DrBlade™, EasyPIM™, EconoBRIDGE™, EconoDUAL™, EconoPACK™, EconoPIM™, EiceDRIVER™, eupec™, FCOS™, HITFET™, HybridPACK™, Infineon™, ISOFACE™, IsoPACK™, i-Wafer™, MIPAQ™, ModSTACK™, my-d™, NovalithIC™, OmniTune™, OPTIGA™, OptiMOS™, ORIGA™, POWERCODE™, PRIMARION™, PrimePACK™, PrimeSTACK™, PROFET™, PRO-SIL™, RASIC™, REAL3™, ReverSave™, SatRIC™, SIEGET™, SIPMOS™, SmartLEWIS™, SOLID FLASH™, SPOC™, TEMPFET™, thinQ!™, TRENCHSTOP™, TriCore™.

Trademarks updated August 2015

Other Trademarks

All referenced product or service names and trademarks are the property of their respective owners.

We Listen to Your Comments

Any information within this document that you feel is wrong, unclear or missing at all? Your feedback will help us to continuously improve the quality of this document. Please send your proposal (including a reference to this document) to:

erratum@infineon.com

Published by

Infineon Technologies AG

81726 München, Germany

© 2017 Infineon Technologies AG

All Rights Reserved.

Legal Disclaimer

The information given in this document shall in no event be regarded as a guarantee of conditions or characteristics ("Beschaffensgarantie").

With respect to any examples, hints or any typical values stated herein and/or any information regarding the application of the product, Infineon Technologies hereby disclaims any and all warranties and liabilities of any kind, including without limitation warranties of non-infringement of intellectual property rights of any third party.

In addition, any information given in this document is subject to customer's compliance with its obligations stated in this document and any applicable legal requirements, norms and standards concerning customer's products and any use of the product of Infineon Technologies in customer's applications.

The data contained in this document is exclusively intended for technically trained staff. It is the responsibility of customer's technical departments to evaluate the suitability of the product for the intended application and the completeness of the product information given in this document with respect to such application.

Information

For further information on technology, delivery terms and conditions and prices please contact your nearest Infineon Technologies Office (www.infineon.com).

Warnings

Due to technical requirements, components may contain dangerous substances. For information on the types in question, please contact the nearest Infineon Technologies Office.

The Infineon Technologies component described in this Data Sheet may be used in life-support devices or systems and/or automotive, aviation and aerospace applications or systems only with the express written approval of Infineon Technologies, if a failure of such components can reasonably be expected to cause the failure of that life-support, automotive, aviation and aerospace device or system or to affect the safety or effectiveness of that device or system. Life support devices or systems are intended to be implanted in the human body or to support and/or maintain and sustain and/or protect human life. If they fail, it is reasonable to assume that the health of the user or other persons may be endangered.