

OPTIREG™ Linear TLS115B0

High Precision Voltage Tracker



Features

- 150 mA current capability
- Very high accuracy voltage tracking
- Output voltage adjustable down to 2.0 V
- Stable with ceramic output capacitors
- Very low dropout voltage
- Very low current consumption in OFF mode
- Internally controlled soft start
- Wide input voltage range: $-16\text{ V} \leq V_{\text{IN}} \leq 45\text{ V}$
- Wide temperature range: $-40^\circ\text{C} \leq T_j \leq 150^\circ\text{C}$
- Short circuit protected output (to GND and to battery)
- Reverse polarity protected input
- Overtemperature protection
- Green Product (RoHS compliant)
- AEC Qualified

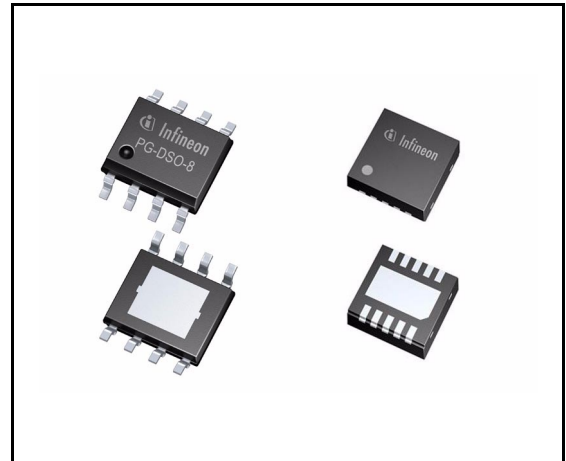

Applications

- Automotive sensor supply
- Protected sensor supply for off-board sensors
- Secondary voltage supply in automotive ECU
- High-precision voltage tracking
- Precision voltage replication
- Power switch for off-board load

Description

The OPTIREG™ Linear TLS115B0 is a monolithic integrated low-dropout voltage tracking regulator with high accuracy in small PG-DSO-8 exposed pad and PG-TSON-10 packages. The TLS115B0 is designed to supply off-board systems, for example sensors in powertrain management systems under the severe conditions of automotive applications. Therefore, the TLS115B0 is equipped with protection functions against reverse polarity and against short circuit to GND and battery.

Up to a supply voltage of 45 V and output currents up to 150 mA, the output voltage follows the reference voltage that is applied to the ADJ input with very high accuracy. The required minimum reference voltage at ADJ is 2.0 V.

OPTIREG™ Linear TLS115B0
High Precision Voltage Tracker



| Type | Package | Marking |
|-------------|----------------|----------------|
| TLS115B0EJ | PG-DSO-8 EP | 115B0 |
| TLS115B0LD | PG-TSON-10 | 115B0 |

Table of Contents

| | | |
|----------|---|-----------|
| | Features | 1 |
| | Applications | 1 |
| | Description | 1 |
| | Table of Contents | 3 |
| 1 | Block diagram | 4 |
| 2 | Pin configuration | 5 |
| 2.1 | Pin assignment TLS115B0EJ in PG-DSO-8 EP package | 5 |
| 2.2 | Pin definitions and functions TLS115B0EJ in PG-DSO-8 EP package | 5 |
| 2.3 | Pin assignment TLS115B0LD in PG-TSON-10 package | 6 |
| 2.4 | Pin definitions and functions TLS115B0LD in PG-TSON-10 package | 6 |
| 3 | General product characteristics | 7 |
| 3.1 | Absolute maximum ratings | 7 |
| 3.2 | Functional range | 8 |
| 3.3 | Thermal resistance | 8 |
| 4 | Block description and electrical characteristics | 10 |
| 4.1 | Tracking regulator | 10 |
| 4.2 | Typical performance characteristics tracking regulator | 12 |
| 4.3 | Current consumption | 15 |
| 4.4 | Typical performance characteristics current consumption | 15 |
| 4.5 | Enable input | 17 |
| 4.6 | Typical performance characteristics Enable input | 17 |
| 4.7 | Adjust input | 18 |
| 4.8 | Typical performance characteristics Adjust input | 18 |
| 5 | Application information | 19 |
| 5.1 | Application diagram | 19 |
| 5.2 | Selection of external components | 19 |
| 5.2.1 | Input pin | 19 |
| 5.2.2 | Output pin | 20 |
| 5.2.3 | Adjust pin | 20 |
| 5.3 | Thermal considerations | 20 |
| 5.4 | Further application information | 21 |
| 6 | Package outlines | 22 |
| 7 | Revision history | 24 |

Block diagram

1 Block diagram

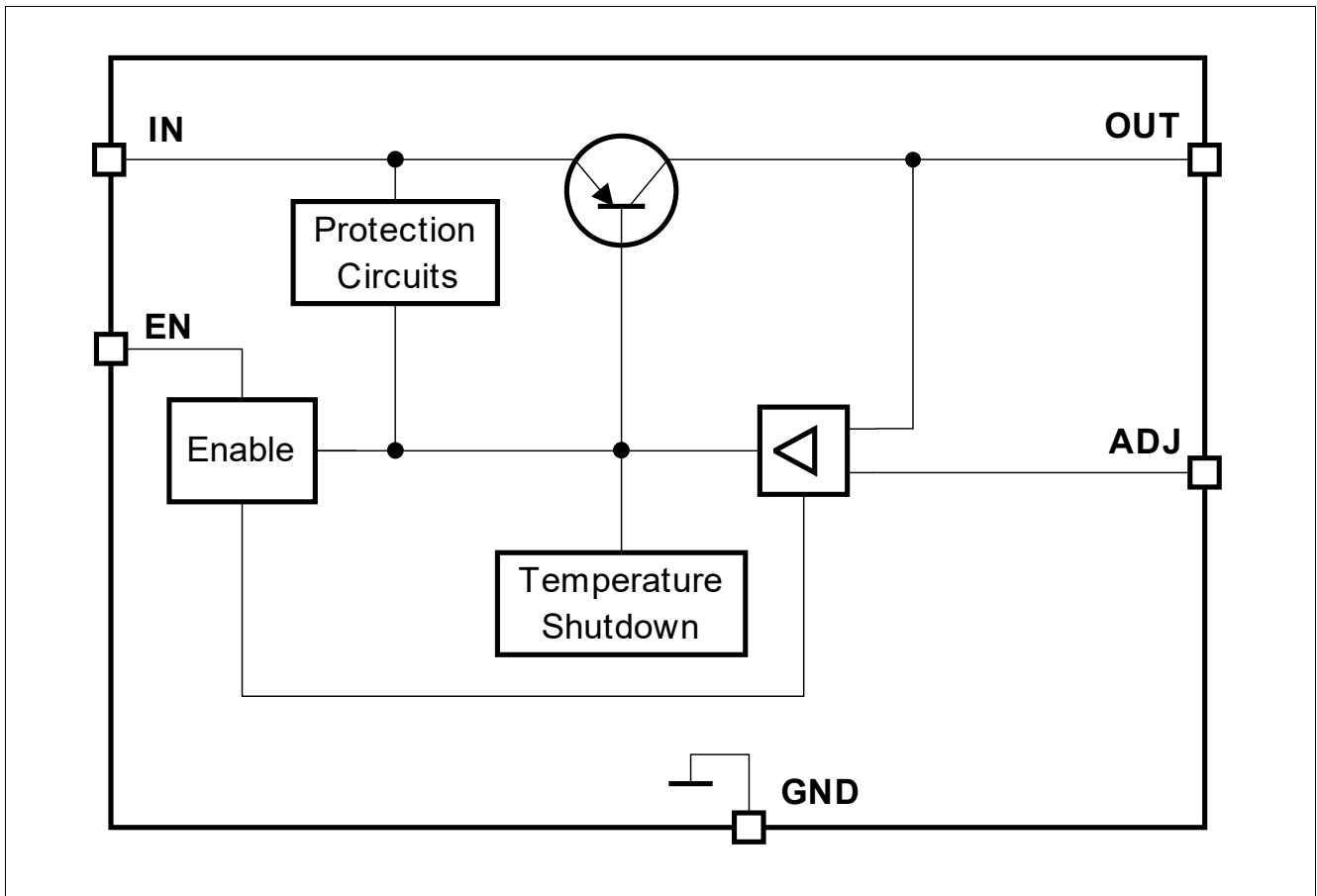

Figure 1 TLS115B0 block diagram

Pin configuration

2 Pin configuration

2.1 Pin assignment TLS115B0EJ in PG-DSO-8 EP package

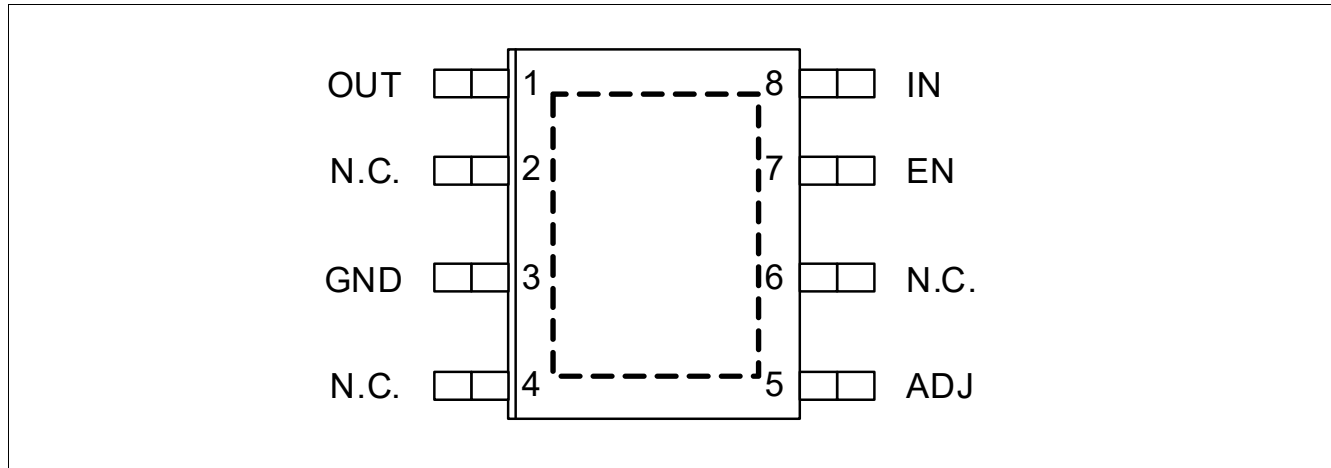

Figure 2 TLS115B0EJ pin configuration

2.2 Pin definitions and functions TLS115B0EJ in PG-DSO-8 EP package

| Pin | Symbol | Function |
|-----|--------|---|
| 1 | OUT | Tracker output 150 mA output current capability Connect to GND with a capacitor close to the pins, respecting capacitance and ESR requirements given in Table 2 Functional range . |
| 2 | N.C. | Not connected |
| 3 | GND | Ground |
| 4 | N.C. | Not connected |
| 5 | ADJ | Adjust Connect to the reference voltage |
| 6 | N.C. | Not Connected |
| 7 | EN | Enable input “High” signal: enables the tracker “Low” signal: disables the tracker If the enable function is not required, then connect EN to IN. |
| 8 | IN | Input It is recommended to connect a small ceramic capacitor to GND close to the pins in order to compensate line influence. |
| Pad | – | Exposed Pad Connect to GND |

Pin configuration

2.3 Pin assignment TLS115B0LD in PG-TSON-10 package

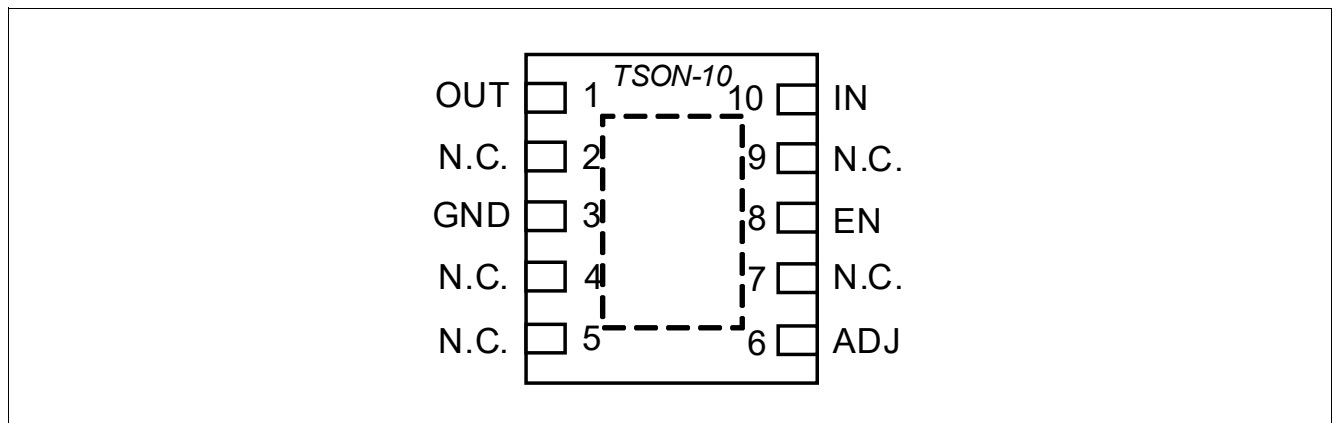

Figure 3 TLS115B0LD pin configuration

2.4 Pin definitions and functions TLS115B0LD in PG-TSON-10 package

| Pin | Symbol | Function |
|---------------|--------|---|
| 1 | OUT | Tracker output 150 mA output current capability Connect to GND with a capacitor close to the pins, respecting capacitance and ESR requirements given in Table 2 Functional range . |
| 3 | GND | Ground |
| 6 | ADJ | Adjust Connect to the reference voltage |
| 8 | EN | Enable input “High” signal: enables the tracker “Low” signal: disables the tracker If the enable function is not required, then connect EN to IN. |
| 10 | IN | Input It is recommended to connect a small ceramic capacitor to GND close to the pins in order to compensate line influence. |
| 2, 4, 5, 7, 9 | N.C. | Not connected |
| Pad | – | Exposed Pad Connect to GND |

General product characteristics

3 General product characteristics

3.1 Absolute maximum ratings

Table 1 Absolute maximum ratings¹⁾

$T_j = -40^\circ\text{C}$ to $+150^\circ\text{C}$; all voltages with respect to ground, positive current flowing into pin (unless otherwise specified)

| Parameter | Symbol | Values | | | Unit | Note or Test Condition | Number |
|--|------------------|--------|------|------|------------------|--|----------|
| | | Min. | Typ. | Max. | | | |
| Input IN | | | | | | | |
| Voltage | V_{IN} | -16 | – | 45 | V | – | P_3.1.1 |
| Enable EN | | | | | | | |
| Voltage | V_{EN} | -16 | – | 45 | V | – | P_3.1.2 |
| Adjust ADJ | | | | | | | |
| Voltage | V_{ADJ} | -16 | – | 45 | V | – | P_3.1.3 |
| Output OUT | | | | | | | |
| Voltage | V_{OUT} | -5 | – | 45 | V | – | P_3.1.4 |
| Input Output Voltage Difference | | | | | | | |
| Voltage | $V_{IN}-V_{OUT}$ | -30 | – | 45 | V | – | P_3.1.5 |
| Temperatures | | | | | | | |
| Junction temperature | T_j | -40 | – | 150 | $^\circ\text{C}$ | – | P_3.1.7 |
| Storage temperature | T_{stg} | -55 | – | 150 | $^\circ\text{C}$ | – | P_3.1.8 |
| ESD Absorption | | | | | | | |
| ESD susceptibility to GND | $V_{ESD,HBM}$ | -4 | – | 4 | kV | Human Body Model (HBM) ²⁾ | P_3.1.9 |
| ESD susceptibility to GND | $V_{ESD,CDM}$ | -1 | – | 1 | kV | Charge Device Model (CDM) ³⁾ | P_3.1.10 |
| ESD susceptibility to GND | $V_{ESD,CDM}$ | -1 | – | 1 | kV | Charge Device Model (CDM) at corner pins ³⁾ | P_3.1.11 |

1) Not subject to production test, specified by design.

2) ESD susceptibility, HBM according to ANSI/ESDA/JEDEC JS001 (1.5 k Ω , 100 pF)

3) ESD susceptibility, Charged Device Model “CDM” according JEDEC JESD22-C101

Notes

1. Stresses above the ones listed here may cause permanent damage to the device. Exposure to absolute maximum rating conditions for extended periods may affect device reliability.
2. Integrated protection functions are designed to prevent IC destruction under fault conditions described in the data sheet. Fault conditions are considered as “outside” normal operating range. Protection functions are not designed for continuous repetitive operation.

General product characteristics

3.2 Functional range

Table 2 Functional range

| Parameter | Symbol | Values | | | Unit | Note or Test Condition | Number |
|---|---------------------|--------|------|------|--------------------|------------------------|---------|
| | | Min. | Typ. | Max. | | | |
| Input voltage range | V_{IN} | 4 | – | 45 | V | – | P_3.2.1 |
| Adjust input voltage range (voltage tracking range) | V_{ADJ} | 2 | – | 14 | V | – | P_3.2.2 |
| Output capacitor | C_{OUT} | 1 | – | – | μF | – ¹⁾²⁾ | P_3.2.3 |
| Output capacitor's Equivalent Series Resistance | ESR (C_{OUT}) | – | – | 5 | Ω | – ²⁾ | P_3.2.4 |
| Junction temperature | T_j | -40 | – | 150 | $^{\circ}\text{C}$ | – ²⁾ | P_3.2.5 |

1) The minimum output capacitance requirement is applicable for a worst case capacitance tolerance of 30%.

2) Not subject to production test, specified by design.

Note: Within the functional or operating range, the IC operates as described in the circuit description. The electrical characteristics are specified within the conditions given in the Electrical Characteristics table.

3.3 Thermal resistance

Note: This thermal data was generated in accordance with JEDEC JESD51 standards. For more information, go to www.jedec.org.

Table 3 Thermal resistance TLS115B0EJ in PG-DSO-8 EP package

| Parameter | Symbol | Values | | | Unit | Note or Test Condition | Number |
|--------------------------------|------------|--------|------|------|------|--|---------|
| | | Min. | Typ. | Max. | | | |
| Junction to case ¹⁾ | R_{thJC} | – | 18 | – | K/W | – | P_3.3.1 |
| Junction to pin | R_{thJP} | – | 85 | – | K/W | – | P_3.3.2 |
| Junction to ambient | R_{thJA} | – | 50 | – | K/W | 2s2p board ²⁾ | P_3.3.3 |
| Junction to ambient | R_{thJA} | – | 157 | – | K/W | 1s0p board, footprint only ³⁾ | P_3.3.4 |
| Junction to ambient | R_{thJA} | – | 77 | – | K/W | 1s0p board, 300 mm ² heatsink area on PCB ³⁾ | P_3.3.5 |
| Junction to Ambient | R_{thJA} | – | 63 | – | K/W | 1s0p board, 600 mm ² heatsink area on PCB ³⁾ | P_3.3.6 |

1) Not subject to production test, specified by design.

2) Specified R_{thJA} value is according to Jecdec JESD51-2,-5,-7 at natural convection on FR4 2s2p board; The product (chip and package) was simulated on a 76.2 × 114.3 × 1.5 mm³ board with 2 inner copper layers (2 × 70 μm Cu, 2 × 35 μm Cu). Where applicable a thermal via array under the exposed pad contacted the first inner copper layer.

3) Specified R_{thJA} value is according to JEDEC JESD 51-3 at natural convection on FR4 1s0p board; The product (chip and package) was simulated on a 76.2 × 114.3 × 1.5 mm³ board with 1 copper layer (1 × 70 μm Cu).

General product characteristics

Table 4 Thermal resistance TLS115B0LD in PG-TSON-10 package

| Parameter | Symbol | Values | | | Unit | Note or Test Condition | Number |
|--------------------------------|------------|--------|------|------|------|--|----------|
| | | Min. | Typ. | Max. | | | |
| Junction to case ¹⁾ | R_{thJC} | – | 17 | – | K/W | – | P_3.3.7 |
| Junction to pin | R_{thJP} | – | 96 | – | K/W | – | P_3.3.8 |
| Junction to ambient | R_{thJA} | – | 67 | – | K/W | 2s2p board ²⁾ | P_3.3.9 |
| Junction to ambient | R_{thJA} | – | 194 | – | K/W | 1s0p board, footprint only ³⁾ | P_3.3.10 |
| Junction to ambient | R_{thJA} | – | 82 | – | K/W | 1s0p board, 300 mm ² heatsink area on PCB ³⁾ | P_3.3.11 |
| Junction to ambient | R_{thJA} | – | 68 | – | K/W | 1s0p board, 600 mm ² heatsink area on PCB ³⁾ | P_3.3.12 |

1) Not subject to production test, specified by design.

2) Specified R_{thJA} value is according to Jedec JESD51-2,-5,-7 at natural convection on FR4 2s2p board; The product (chip and package) was simulated on a 76.2 × 114.3 × 1.5 mm³ board with 2 inner copper layers (2 × 70 μm Cu, 2 × 35 μm Cu). Where applicable a thermal via array under the exposed pad contacted the first inner copper layer.

3) Specified R_{thJA} value is according to JEDEC JESD 51-3 at natural convection on FR4 1s0p board; The product (chip and package) was simulated on a 76.2 × 114.3 × 1.5 mm³ board with 1 copper layer (1 × 70 μm Cu).

Block description and electrical characteristics

4 Block description and electrical characteristics

4.1 Tracking regulator

The regulator controls the output voltage V_{OUT} by comparing it to the voltage applied to the ADJ pin and driving a PNP pass transistor accordingly. The stability of the control loop depends on:

- the output capacitor C_{OUT}
- load current
- chip temperature
- the poles and zeroes in the frequency response of the circuit consisting of TLS115B0 and the load

An input capacitor C_{IN} is strongly recommended for buffering the line influence.

To ensure stable operation, the output capacitor's capacitance and its equivalent series resistance *ESR* requirements given in the table **“Functional range” on Page 8** must be maintained. For details see also the typical performance graph **“Output capacitor ESR(COUT) vs. output current IOUT” on Page 14**. The output capacitor must be sized suitably to buffer load transients.

Connect each capacitor close to the pins.

Protection circuitry prevents the TLS115B0 itself as well as the application from destruction in case of catastrophic events. These safeguards contain:

- output current limitation
- reverse polarity protection
- thermal shutdown

In order to protect the pass element and the package from excessive power dissipation the TLS115B0 reduces the maximum output current at high input voltage.

The TLS115B0 allows a negative supply voltage. However, in reverse polarity condition several low currents flowing into the TLS115B0 increase junction temperature. Thermal design must consider this effect, because in reverse polarity condition the overtemperature protection circuit does not operate.

The overtemperature protection circuit prevents immediate destruction of the TLS115B0 in certain fault conditions (for example a permanent short circuit at output) by switching off the power stage. After the chip cools down, the regulator restarts. If the fault is not removed, then this leads to an oscillatory behavior of the output voltage. Please note, that a junction temperature above 150°C is outside the maximum ratings and reduces the lifetime of the TLS115B0.

Table 5 Electrical characteristics tracking regulator

$V_{IN} = 13.5\text{ V}$, $2.0\text{ V} \leq V_{ADJ} \leq 14\text{ V}$, $V_{EN} \geq 2.0\text{ V}$, $T_j = -40^\circ\text{C}$ to $+150^\circ\text{C}$, all voltages with respect to ground, positive current flowing into pin (unless otherwise specified).

| Parameter | Symbol | Values | | | Unit | Note or Test Condition | Number |
|--|------------------|--------|------|------|------|--|---------|
| | | Min. | Typ. | Max. | | | |
| Tracking output | | | | | | | |
| Output voltage tracking accuracy $\Delta V_{OUT} = V_{ADJ} - V_{OUT}$ | ΔV_{OUT} | -5 | - | 5 | mV | $5.5\text{ V} \leq V_{IN} \leq 22\text{ V}$; $0.1\text{ mA} \leq I_{OUT} \leq 150\text{ mA}$; $2\text{ V} \leq V_{ADJ} \leq V_{IN} - 1\text{ V}$ | P_4.1.1 |

Block description and electrical characteristics

Table 5 Electrical characteristics tracking regulator (cont'd)

$V_{IN} = 13.5\text{ V}$, $2.0\text{ V} \leq V_{ADJ} \leq 14\text{ V}$, $V_{EN} \geq 2.0\text{ V}$, $T_j = -40^\circ\text{C}$ to $+150^\circ\text{C}$, all voltages with respect to ground, positive current flowing into pin (unless otherwise specified).

| Parameter | Symbol | Values | | | Unit | Note or Test Condition | Number |
|--|-----------------------|--------|------|------|------|---|----------|
| | | Min. | Typ. | Max. | | | |
| Output voltage tracking accuracy $\Delta V_{OUT} = V_{ADJ} - V_{OUT}$ | ΔV_{OUT} | -5 | - | 5 | mV | $5.5\text{ V} \leq V_{IN} \leq 32\text{ V}$; $0.1\text{ mA} \leq I_{OUT} \leq 70\text{ mA}$; $2\text{ V} \leq V_{ADJ} \leq V_{IN} - 1\text{ V}$ | P_4.1.2 |
| Load regulation steady-state | $\Delta V_{OUT,load}$ | -4 | -0.1 | - | mV | $I_{OUT} = 0.1\text{ mA}$ to 150 mA ; $V_{ADJ} = 5\text{ V}$ | P_4.1.3 |
| Line regulation steady-state | $\Delta V_{OUT,line}$ | - | 0.1 | 4 | mV | $V_{IN} = 5.5\text{ V}$ to 32 V ; $I_{OUT} = 10\text{ mA}$; $V_{ADJ} = 5\text{ V}$ | P_4.1.4 |
| Power supply ripple rejection ¹⁾ | <i>PSRR</i> | - | 85 | - | dB | $f_{ripple} = 100\text{ Hz}$; $V_{ripple} = 1\text{ Vpp}$; $I_{OUT} = 10\text{ mA}$; $C_{OUT} = 10\text{ }\mu\text{F}$, ceramic type | P_4.1.5 |
| Output current limitation | $I_{OUT,max}$ | 151 | 350 | 500 | mA | $V_{OUT} = V_{ADJ} - 0.1\text{ V}$; $V_{ADJ} = 5\text{ V}$ | P_4.1.6 |
| Reverse current | $I_{OUT,rev}$ | -3.5 | -1.7 | - | mA | $V_{IN} = 0\text{ V}$; $V_{OUT} = 16\text{ V}$; $V_{ADJ} = 5\text{ V}$ | P_4.1.9 |
| Reverse current at negative input voltage | $I_{IN,rev}$ | -4 | -2 | - | mA | $V_{IN} = -16\text{ V}$; $V_{OUT} = 0\text{ V}$; $V_{ADJ} = 5\text{ V}$ | P_4.1.10 |
| Dropout voltage ²⁾ $V_{dr} = V_{IN} - V_{OUT}$ | V_{dr} | - | 250 | 500 | mV | $I_{OUT} = 150\text{ mA}$; $V_{ADJ} = 5\text{ V}$ ²⁾ | P_4.1.11 |

Overtemperature protection

| | | | | | | | |
|---|--------------------|---|-----|---|----|---|----------|
| Overtemperature shutdown threshold | $T_{j,sd}$ | - | 175 | - | °C | T_j increasing due to power dissipation generated by the IC | P_4.1.15 |
| Overtemperature shutdown threshold hysteresis | $\Delta T_{j,sdh}$ | - | 15 | - | K | | P_4.1.16 |

1) Not subject to production test, specified by design

2) Measured when the output voltage V_{OUT} has dropped 100 mV from the nominal value obtained at $V_{IN} = 13.5\text{ V}$

4.2 Typical performance characteristics tracking regulator

Tracking accuracy ΔV_{OUT} vs. junction temperature T_j

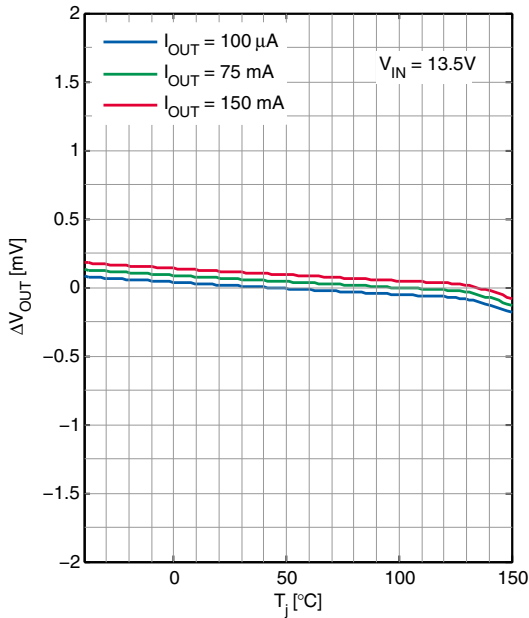

Output current limitation $I_{OUT,max}$ vs. input voltage V_{IN}

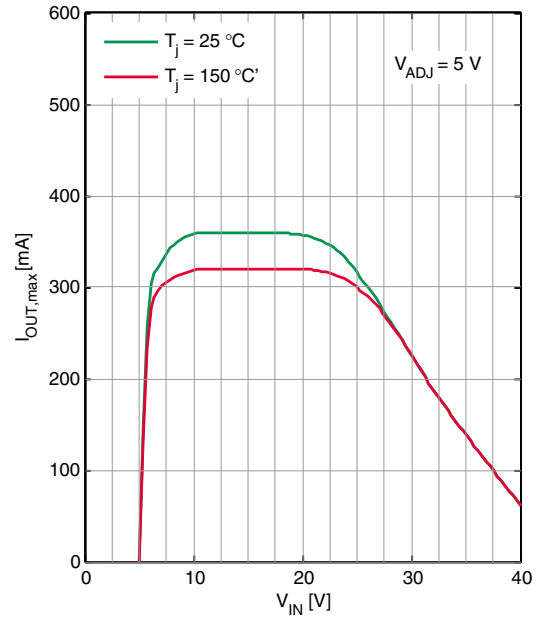

Output voltage V_{OUT} vs. adjust voltage V_{ADJ}

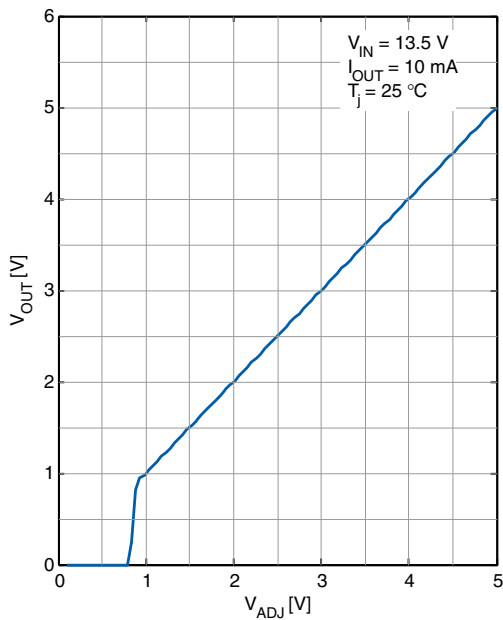

Output voltage V_{OUT} vs. input voltage V_{IN}

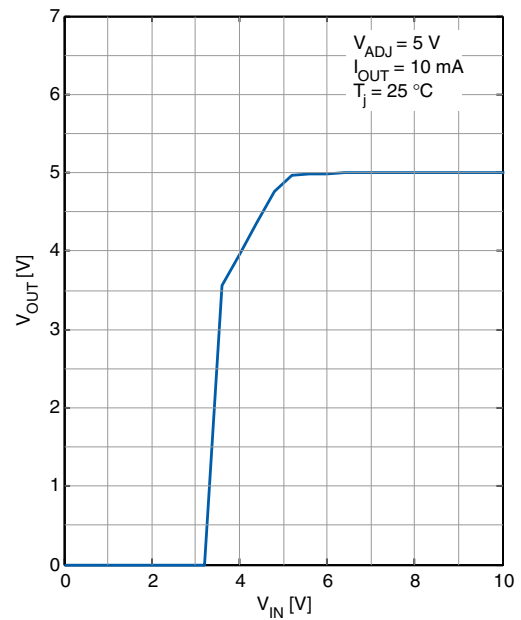

Block description and electrical characteristics

Load regulation $\Delta V_{OUT,load}$ vs. output current I_{OUT}

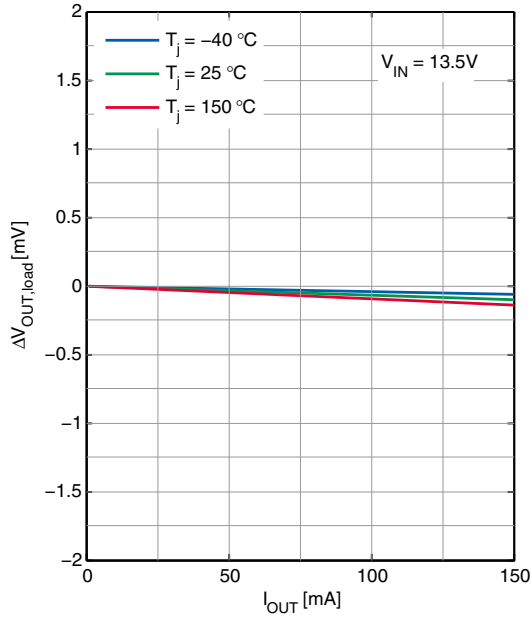

Line regulation $\Delta V_{OUT,line}$ vs. input voltage V_{IN}

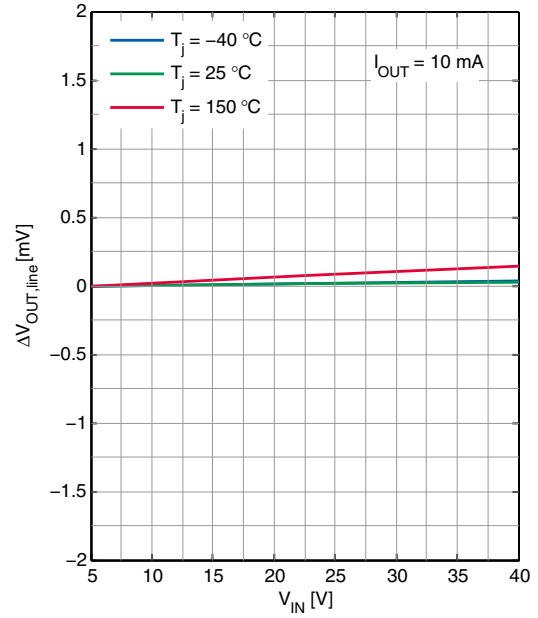

Dropout voltage V_{dr} vs. junction temperature T_j

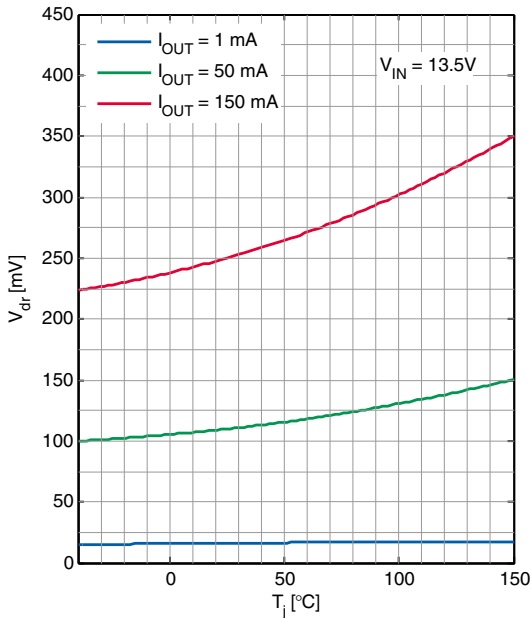

Dropout voltage V_{dr} vs. output current I_{OUT}

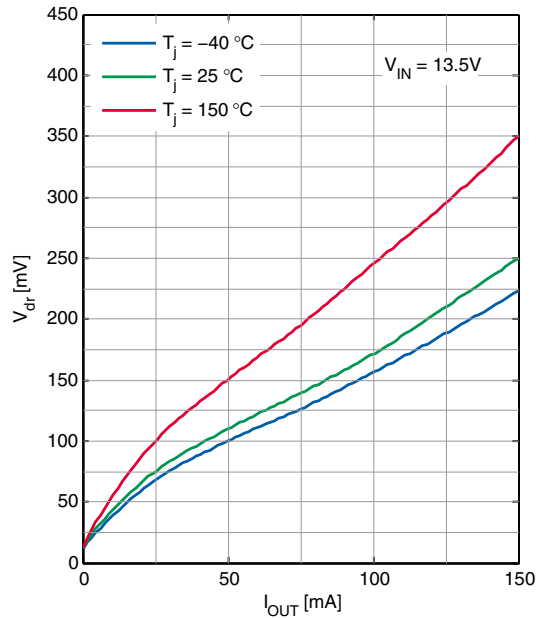

Block description and electrical characteristics

Reverse current $I_{IN,rev}$ vs. input voltage V_{IN}

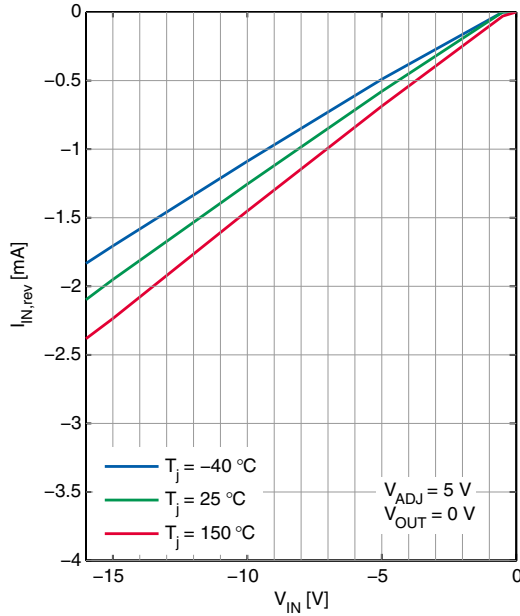

Reverse current $I_{OUT,rev}$ vs. output voltage V_{OUT}

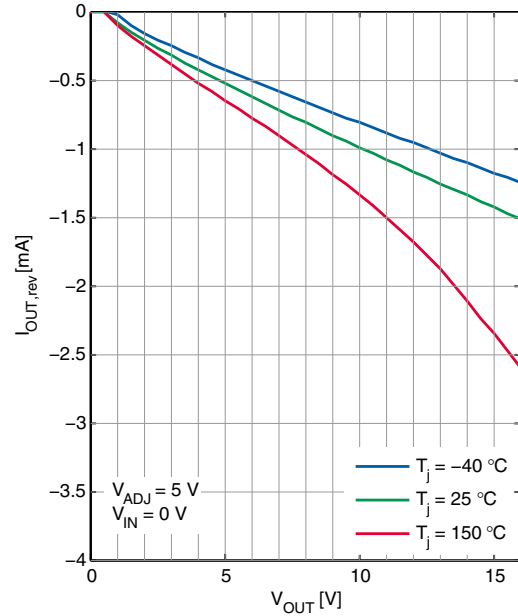

Power supply ripple rejection $PSRR$ vs. ripple frequency f_r

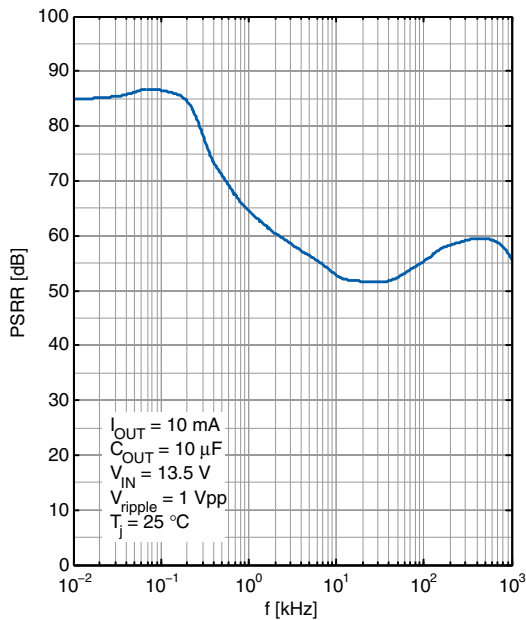

Output capacitor $ESR(C_{OUT})$ vs. output current I_{OUT}

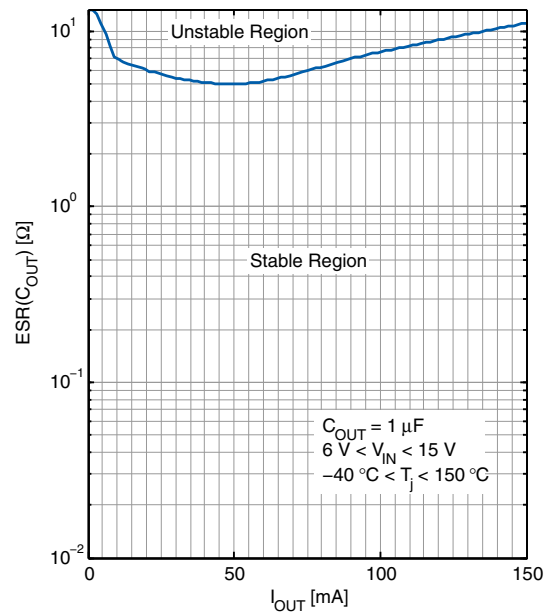

Block description and electrical characteristics

4.3 Current consumption

Table 6 Electrical characteristics current consumption

$V_{IN} = 13.5\text{ V}$, $2.0\text{ V} \leq V_{ADJ} \leq 14\text{ V}$, $V_{EN} \geq 2.0\text{ V}$, $T_j = -40^\circ\text{C}$ to $+150^\circ\text{C}$, all voltages with respect to ground, positive current flowing into pin (unless otherwise specified).

| Parameter | Symbol | Values | | | Unit | Note or Test Condition | Number |
|---|-------------|--------|------|------|---------------|--|---------|
| | | Min. | Typ. | Max. | | | |
| Current consumption Stand-by mode $I_{q,off} = I_{IN}$ | $I_{q,off}$ | – | 0.1 | 5 | μA | $V_{EN} \leq 0.4\text{ V}$; $T_j \leq 125^\circ\text{C}$ | P_4.3.1 |
| Current consumption $I_q = I_{IN} - I_{OUT}$ | I_q | – | 55 | 90 | μA | $I_{OUT} \leq 0.1\text{ mA}$; $V_{ADJ} = 5\text{ V}$; $T_j \leq 125^\circ\text{C}$ | P_4.3.2 |
| Current consumption $I_q = I_{IN} - I_{OUT}$ | I_q | – | 7 | 14 | mA | $I_{OUT} \leq 150\text{ mA}$; $V_{ADJ} = 5\text{ V}$ | P_4.3.3 |

4.4 Typical performance characteristics current consumption

Current consumption I_q vs. output current I_{OUT}

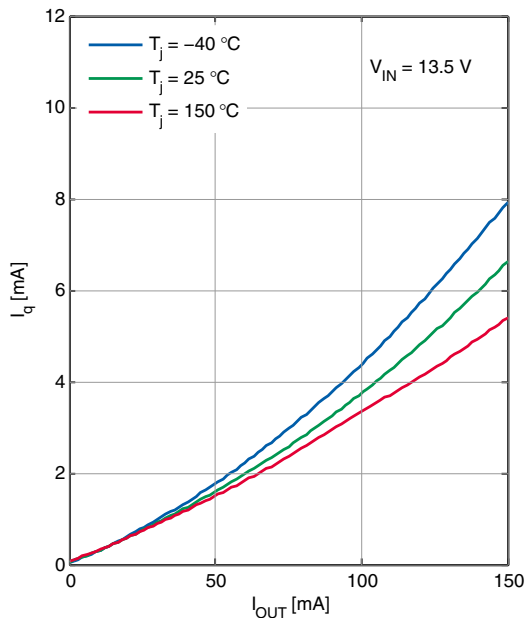

Current consumption I_q vs. input voltage V_{IN}

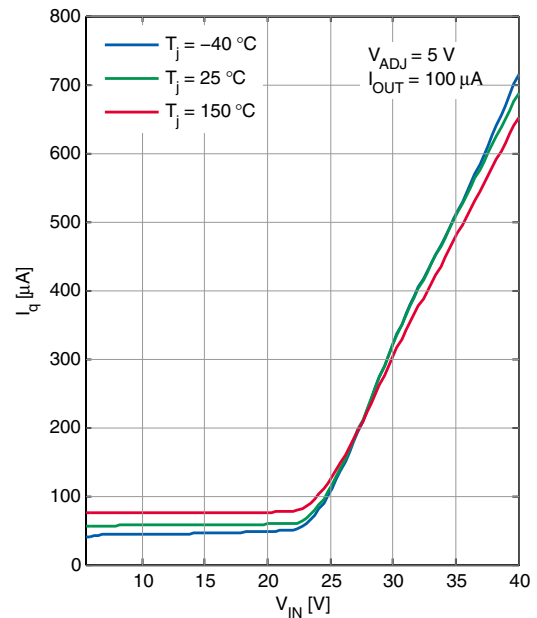

Block description and electrical characteristics

Current consumption I_q vs. junction temperature T_j

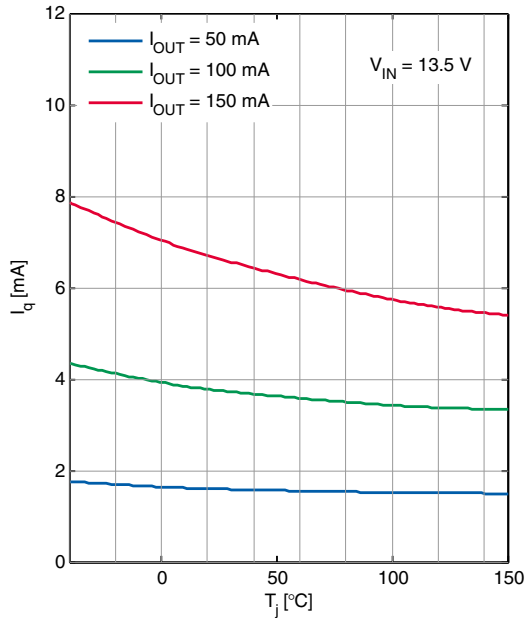

Current consumption I_q vs. junction temperature T_j (I_{OUT} low)

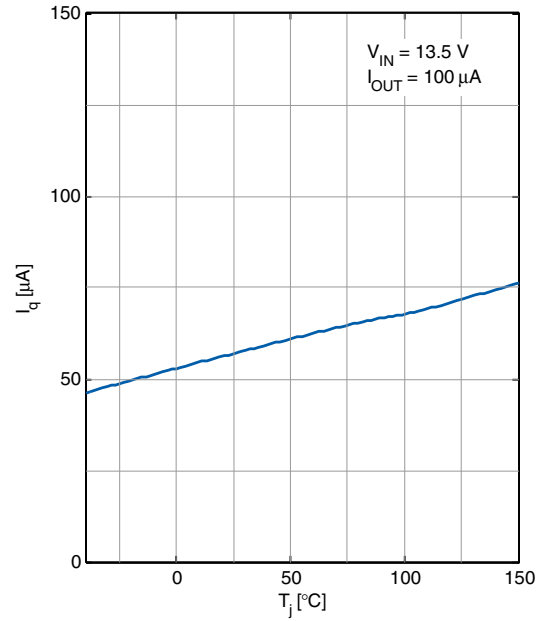

Current consumption in OFF mode $I_{q,off}$ vs. junction temperature T_j

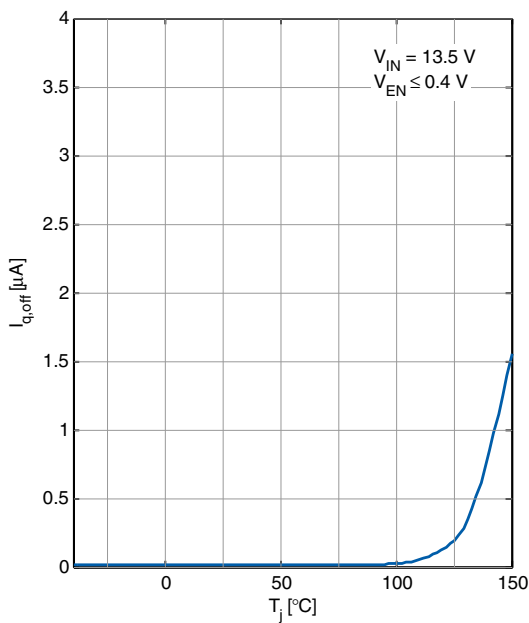

Block description and electrical characteristics

4.5 Enable input

In order to minimize the quiescent current, the TLS115B0 can be switched to stand-by mode by setting the corresponding enable input “EN” to “low”.

If the EN pin is not connected, then the “low” level from the internal pull-down resistor switches off the regulator.

Table 7 Electrical characteristics Enable input

$V_{IN} = 13.5\text{ V}$, $2.0\text{ V} \leq V_{ADJ} \leq 14\text{ V}$, $T_j = -40^\circ\text{C}$ to $+150^\circ\text{C}$, all voltages with respect to ground, positive current flowing into pin (unless otherwise specified).

| Parameter | Symbol | Values | | | Unit | Note or Test Condition | Number |
|--------------------------|--------------|--------|------|------|---------------|---|---------|
| | | Min. | Typ. | Max. | | | |
| Enable off voltage range | $V_{EN,off}$ | – | – | 0.8 | V | $V_{OUT} = 0\text{ V}$, $I_{OUT} \leq 5\ \mu\text{A}$, $T_j \leq 125^\circ\text{C}$ | P_4.5.1 |
| Enable on voltage range | $V_{EN,on}$ | 2 | – | – | V | V_{OUT} settled | P_4.5.2 |
| Enable input current | I_{EN} | – | 2 | 4 | μA | $V_{EN} = 5\text{ V}$ | P_4.5.3 |

4.6 Typical performance characteristics Enable input

**Enable input current I_{EN} vs.
 Enable input voltage V_{EN}**

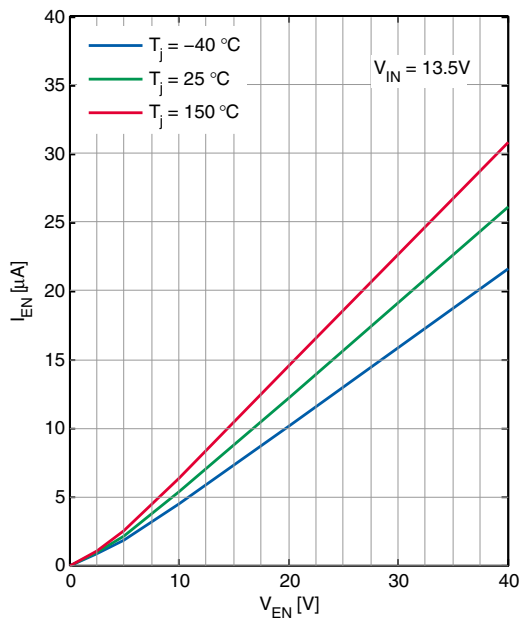

Block description and electrical characteristics

4.7 Adjust input

The Adjust input must be connected to the reference voltage, which is tracked.

Table 8 Electrical characteristics Adjust input

$V_{IN} = 13.5\text{ V}$, $2.0\text{ V} \leq V_{ADJ} \leq 14\text{ V}$, $V_{EN} \geq 2.0\text{ V}$, $T_j = -40^\circ\text{C}$ to $+150^\circ\text{C}$, all voltages with respect to ground, positive current flowing into pin (unless otherwise specified).

| Parameter | Symbol | Values | | | Unit | Note or Test Condition | Number |
|----------------------|-----------|--------|------|------|---------------|------------------------|---------|
| | | Min. | Typ. | Max. | | | |
| Adjust input current | I_{ADJ} | – | 0.03 | 1 | μA | $V_{ADJ} = 5\text{ V}$ | P_4.7.1 |

4.8 Typical performance characteristics Adjust input

Adjust input current I_{ADJ} vs. Adjust input voltage V_{ADJ}

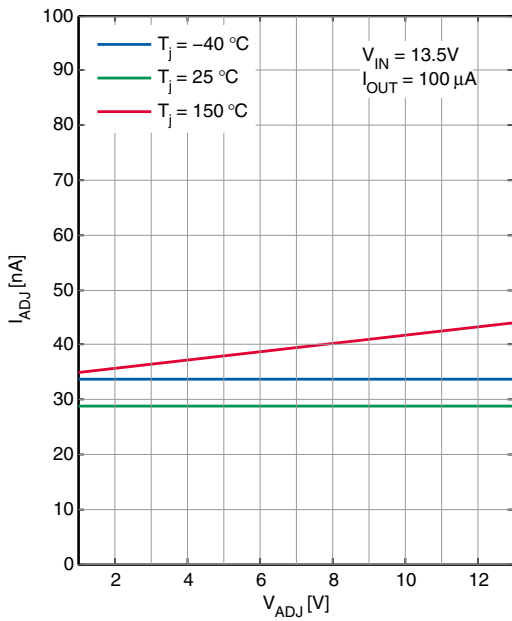

Adjust input current I_{ADJ} vs. junction temperature T_j

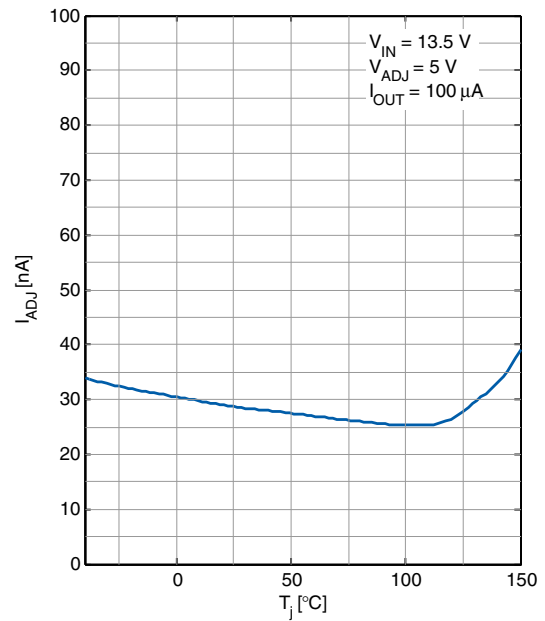

Application information

5 Application information

Note: The following information is given as a hint for the implementation of the device only and shall not be regarded as a description or warranty of a certain functionality, condition or quality of the device.

5.1 Application diagram

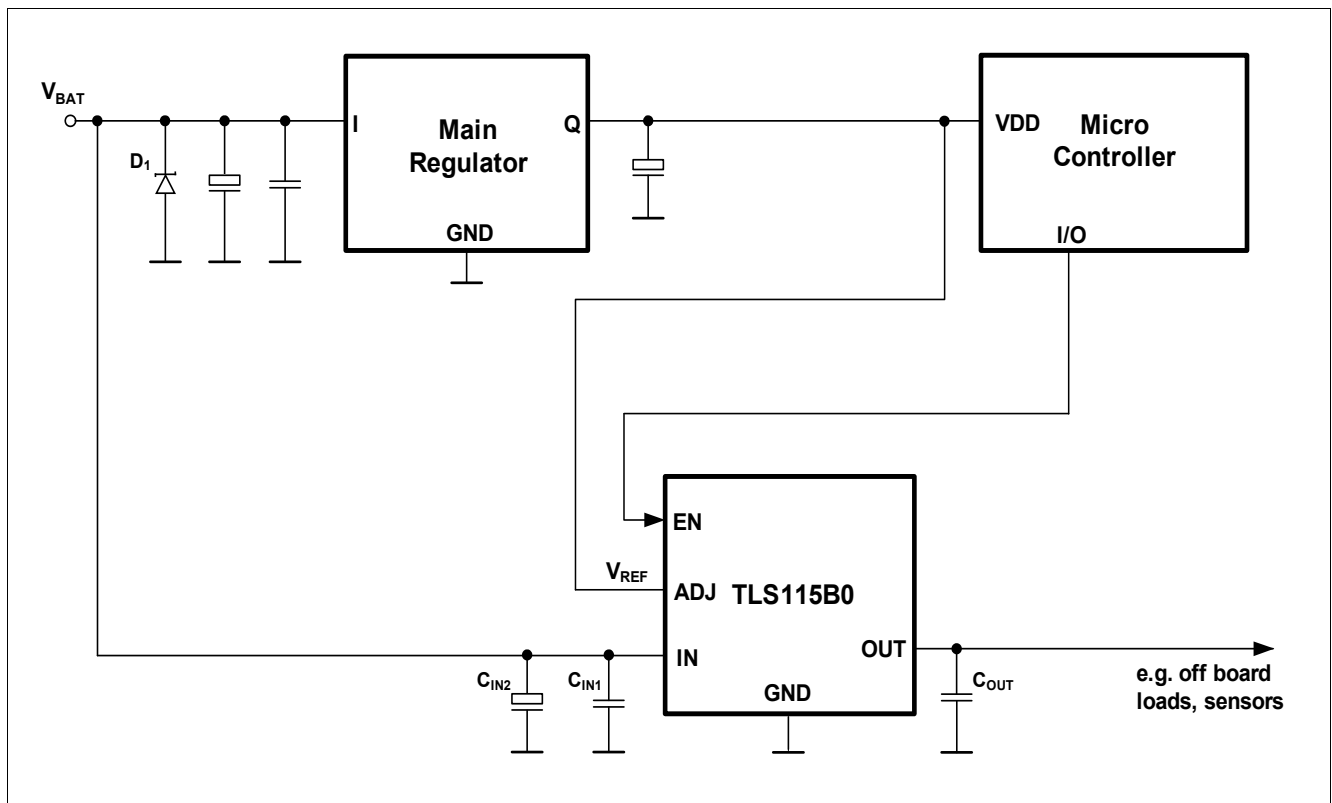

Figure 4 TLS115B0 application circuit

5.2 Selection of external components

5.2.1 Input pin

Figure 4 shows the typical input circuitry for a voltage tracking regulator. The following external components at the input are recommended in case of possible external disturbance.

A ceramic capacitor C_{IN1} (100 nF to 470 nF) at the input filters high frequency disturbance imposed by the line, such as ISO pulses 3a/b. Place C_{IN1} very close to the input pin of the voltage tracking regulator on the PCB.

An aluminum electrolytic capacitor C_{IN2} (10 μ F to 470 μ F) at the input smoothens high energy pulses, such as ISO pulse 2a. Place C_{IN2} close to the input pin of the voltage tracking regulator on the PCB.

An accordingly sized overvoltage suppressor diode D_1 suppresses high voltage beyond the maximum ratings of the circuit components and protects the devices from damage due to overvoltage.

Application information

5.2.2 Output pin

An output capacitor C_{OUT} is mandatory for the stability of the voltage tracking regulator. The requirements for C_{OUT} are described in the table “**Functional range**” on Page 8. The graph “**Output capacitor ESR(COUT) vs. output current IOUT**” on Page 14 shows the stable operation range of the TLS115B0.

For automotive environment, ceramic capacitors with X5R or X7R dielectrics are recommended.

Place C_{OUT} on the same side of the PCB as the regulator itself and as close as possible to both the tracker output pin and GND pin.

In case of rapid transients of input voltage or load current, C_{OUT} must be dimensioned properly to ensure the output stability in the application.

5.2.3 Adjust pin

Figure 4 shows a typical Adjust circuitry for a voltage tracking regulator. Typically the Adjust Pin is connected to a fixed voltage reference that the regulator tracks. In the example of the application diagram ADJ is connected to the supply voltage of a microcontroller. The voltage reference can also be adjusted by a voltage divider.

5.3 Thermal considerations

Knowing the input voltage, the output voltage and the load profile of the application, the total power dissipation can be calculated:

$$P_D = (V_{IN} - V_{OUT}) \times I_{OUT} + V_{IN} \times I_q \quad (5.1)$$

with

- P_D : continuous power dissipation
- V_{IN} : input voltage
- V_{OUT} : output voltage
- I_{OUT} : output current
- I_q : quiescent current

The maximum acceptable thermal resistance R_{thJA} can then be calculated:

$$R_{thJA, \max} = \frac{T_{j, \max} - T_a}{P_D} \quad (5.2)$$

with

- $T_{j, \max}$: maximum allowed junction temperature
- T_a : ambient temperature

Based on the above calculation the proper PCB type and the necessary heat sink area can be determined with reference to the specification in “**Thermal resistance**” on Page 8.

Example

Application conditions:

$$V_{IN} = 13.5 \text{ V}$$

$$V_{OUT} = V_{ADJ} = 5 \text{ V}$$

$$I_{OUT} = 100 \text{ mA}$$

Application information

$$T_a = 75^\circ\text{C}$$

Calculation of $R_{\text{thJA,max}}$:

$$\begin{aligned} P_D &= (V_{\text{IN}} - V_{\text{OUT}}) \times I_{\text{OUT}} + V_{\text{IN}} \times I_q \\ &= (13.5\text{V} - 5\text{V}) \times 100\text{ mA} + 13.5\text{ V} \times 3.5\text{ mA} \\ &= 0.897\text{ W} \end{aligned}$$

$$\begin{aligned} R_{\text{thJA,max}} &= (T_{\text{j,max}} - T_a) / P_D \\ &= (150^\circ\text{C} - 75^\circ\text{C}) / 0.897\text{ W} \\ &= 83.61\text{ K/W} \end{aligned}$$

As a result, the PCB design must ensure a thermal resistance R_{thJA} lower than 83.61 K/W. According to **“Thermal resistance” on Page 8**, at least 300 mm² heatsink area is required on the FR4 1s0p PCB, or the FR4 2s2p board can be used.

5.4 Further application information

- For further information you may contact <http://www.infineon.com/>

Package outlines

6 Package outlines

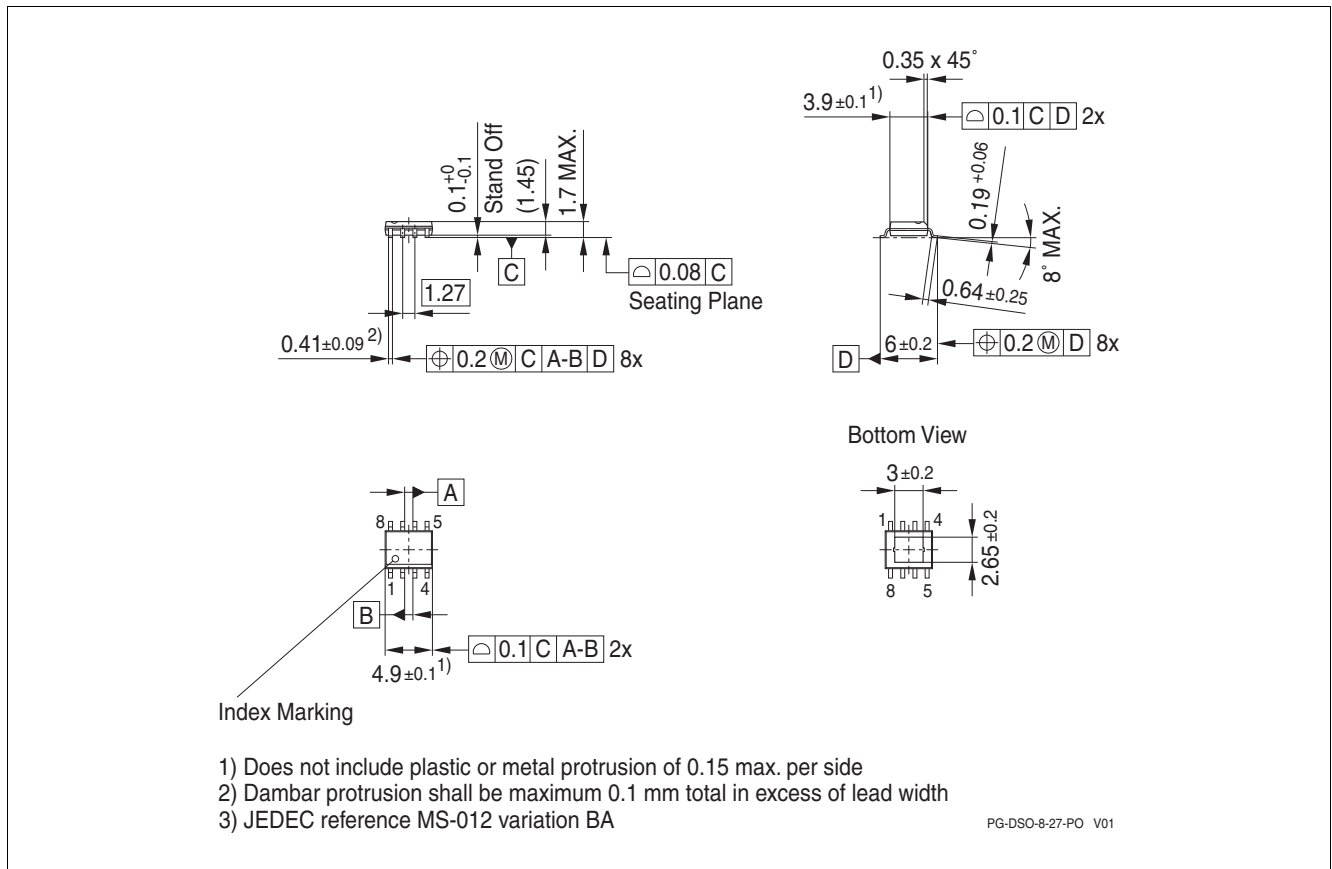

Figure 5 PG-DSO-8 EP

Package outlines

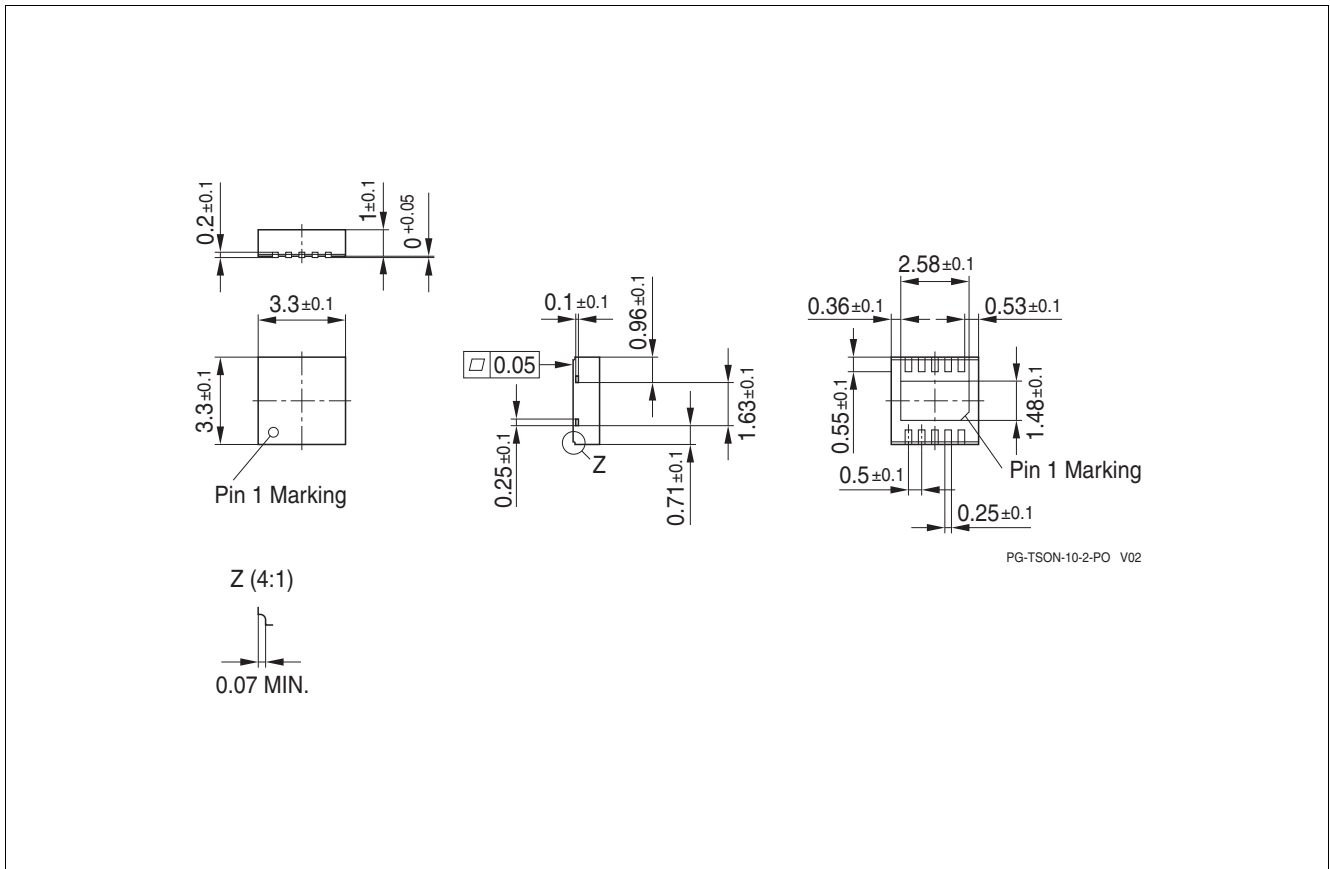

Figure 6 PG-TSON-10

Green Product (RoHS compliant)

To meet the world-wide customer requirements for environmentally friendly products and to be compliant with government regulations the device is available as a green product. Green products are RoHS-Compliant (i.e Pb-free finish on leads and suitable for Pb-free soldering according to IPC/JEDEC J-STD-020).

Revision history

7 Revision history

| Revision | Date | Changes |
|-----------------|-------------|---|
| 1.10 | 2020-03-19 | Data Sheet - updated - Maximum rating for the input output voltage difference added - Editorial changes |
| 1.00 | 2016-10-13 | Data Sheet - Initial Version |

Trademarks

All referenced product or service names and trademarks are the property of their respective owners.

Edition 2020-03-19

Published by

Infineon Technologies AG

81726 Munich, Germany

© 2020 Infineon Technologies AG.

All Rights Reserved.

Do you have a question about any aspect of this document?

Email: erratum@infineon.com

Document reference

Z8F55515725

IMPORTANT NOTICE

The information given in this document shall in no event be regarded as a guarantee of conditions or characteristics ("Beschaffheitsgarantie").

With respect to any examples, hints or any typical values stated herein and/or any information regarding the application of the product, Infineon Technologies hereby disclaims any and all warranties and liabilities of any kind, including without limitation warranties of non-infringement of intellectual property rights of any third party.

In addition, any information given in this document is subject to customer's compliance with its obligations stated in this document and any applicable legal requirements, norms and standards concerning customer's products and any use of the product of Infineon Technologies in customer's applications.

The data contained in this document is exclusively intended for technically trained staff. It is the responsibility of customer's technical departments to evaluate the suitability of the product for the intended application and the completeness of the product information given in this document with respect to such application.

For further information on technology, delivery terms and conditions and prices, please contact the nearest Infineon Technologies Office (www.infineon.com).

WARNINGS

Due to technical requirements products may contain dangerous substances. For information on the types in question please contact your nearest Infineon Technologies office.

Except as otherwise explicitly approved by Infineon Technologies in a written document signed by authorized representatives of Infineon Technologies, Infineon Technologies' products may not be used in any applications where a failure of the product or any consequences of the use thereof can reasonably be expected to result in personal injury.