

# MOSFET

## 600V CoolMOS™ CE Power Transistor

CoolMOS™ is a revolutionary technology for high voltage power MOSFETs, designed according to the superjunction (SJ) principle and pioneered by Infineon Technologies. CoolMOS™ CE is a price-performance optimized platform enabling to target cost sensitive applications in Consumer and Lighting markets by still meeting highest efficiency standards. The new series provides all benefits of a fast switching Superjunction MOSFET while not sacrificing ease of use and offering the best cost down performance ratio available on the market.

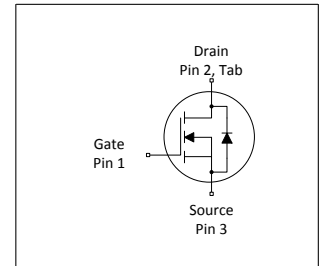
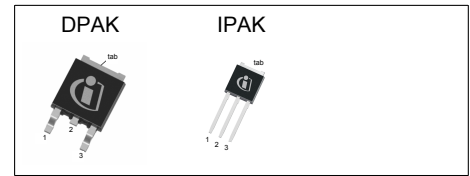

### Features

- Extremely low losses due to very low FOM  $R_{DS(on)} \cdot Q_g$  and  $E_{oss}$
- Very high commutation ruggedness
- Easy to use/drive
- Pb-free plating, Halogen free mold compound
- Qualified for standard grade applications

### Applications

PFC stages, hard switching PWM stages and resonant switching stages for e.g. PC Silverbox, Adapter, LCD & PDP TV and indoor lighting.

*Please note: For MOSFET paralleling the use of ferrite beads on the gate or separate totem poles is generally recommended.*



**Table 1 Key Performance Parameters**

Parameter	Value	Unit
$V_{DS} @ T_{j,max}$	650	V
$R_{DS(on),max}$	1500	mΩ
$I_d$	5	A
$Q_{g,typ}$	9.4	nC
$I_{D,pulse}$	8	A
$E_{oss}@400V$	1	μJ

Type / Ordering Code	Package	Marking	Related Links
IPD60R1K5CE	PG-TO 252	60S1K5CE	see Appendix A
IPU60R1K5CE	PG-TO 251		

## Table of Contents

Description .....	1
Maximum ratings .....	3
Thermal characteristics .....	3
Electrical characteristics .....	4
Electrical characteristics diagrams .....	6
Test Circuits .....	10
Package Outlines .....	11
Appendix A .....	13
Revision History .....	14
Trademarks .....	14
Disclaimer .....	14

## 1 Maximum ratings

at  $T_j = 25^\circ\text{C}$ , unless otherwise specified

**Table 2 Maximum ratings**

Parameter	Symbol	Values			Unit	Note / Test Condition
		Min.	Typ.	Max.		
Continuous drain current <sup>1)</sup>	$I_D$	-	-	5 3.2	A	$T_C=25^\circ\text{C}$ $T_C=100^\circ\text{C}$
Pulsed drain current <sup>2)</sup>	$I_{D,pulse}$	-	-	8	A	$T_C=25^\circ\text{C}$
Avalanche energy, single pulse	$E_{AS}$	-	-	26	mJ	$I_D=0.6\text{A}$ ; $V_{DD}=50\text{V}$ ; see table 11
Avalanche energy, repetitive	$E_{AR}$	-	-	0.09	mJ	$I_D=0.6\text{A}$ ; $V_{DD}=50\text{V}$ ; see table 11
Avalanche current, repetitive	$I_{AR}$	-	-	0.6	A	-
MOSFET dv/dt ruggedness	dv/dt	-	-	50	V/ns	$V_{DS}=0\dots480\text{V}$
Gate source voltage (static)	$V_{GS}$	-20	-	20	V	static;
Gate source voltage (dynamic)	$V_{GS}$	-30	-	30	V	AC ( $f>1\text{ Hz}$ )
Power dissipation TO-251, TO252	$P_{tot}$	-	-	49	W	$T_C=25^\circ\text{C}$
Storage temperature	$T_{stg}$	-40	-	150	$^\circ\text{C}$	-
Operating junction temperature	$T_j$	-40	-	150	$^\circ\text{C}$	-
Continuous diode forward current	$I_S$	-	-	3.5	A	$T_C=25^\circ\text{C}$
Diode pulse current <sup>2)</sup>	$I_{S,pulse}$	-	-	8	A	$T_C=25^\circ\text{C}$
Reverse diode dv/dt <sup>3)</sup>	dv/dt	-	-	15	V/ns	$V_{DS}=0\dots400\text{V}$ , $I_{SD}\leq I_S$ , $T_j=25^\circ\text{C}$ see table 9
Maximum diode commutation speed	di/dt	-	-	500	A/ $\mu\text{s}$	$V_{DS}=0\dots400\text{V}$ , $I_{SD}\leq I_S$ , $T_j=25^\circ\text{C}$ see table 9

## 2 Thermal characteristics

**Table 3 Thermal characteristics TO-251, TO252**

Parameter	Symbol	Values			Unit	Note / Test Condition
		Min.	Typ.	Max.		
Thermal resistance, junction - case	$R_{thJC}$	-	-	2.57	$^\circ\text{C/W}$	-
Thermal resistance, junction - ambient	$R_{thJA}$	-	-	62	$^\circ\text{C/W}$	leaded
Soldering temperature, wavesoldering only allowed at leads	$T_{sold}$	-	-	260	$^\circ\text{C}$	1.6mm (0.063 in.) from case for 10s

<sup>1)</sup> Limited by  $T_{j,max}$ . Maximum duty cycle  $D=0.50$

<sup>2)</sup> Pulse width  $t_p$  limited by  $T_{j,max}$

<sup>3)</sup> Identical low side and high side switch with identical  $R_G$

### 3 Electrical characteristics

at  $T_j=25^\circ\text{C}$ , unless otherwise specified

**Table 4 Static characteristics**

Parameter	Symbol	Values			Unit	Note / Test Condition
		Min.	Typ.	Max.		
Drain-source breakdown voltage	$V_{(BR)DSS}$	600	-	-	V	$V_{GS}=0V, I_D=0.25mA$
Gate threshold voltage	$V_{(GS)th}$	2.5	3.0	3.5	V	$V_{DS}=V_{GS}, I_D=0.09mA$
Zero gate voltage drain current	$I_{DSS}$	-	-	1	$\mu A$	$V_{DS}=600, V_{GS}=0V, T_j=25^\circ C$ $V_{DS}=600, V_{GS}=0V, T_j=150^\circ C$
Gate-source leakage current	$I_{GSS}$	-	-	100	nA	$V_{GS}=20V, V_{DS}=0V$
Drain-source on-state resistance	$R_{DS(on)}$	-	1.26 3.28	1.50	$\Omega$	$V_{GS}=10V, I_D=1.1A, T_j=25^\circ C$ $V_{GS}=10V, I_D=1.1A, T_j=150^\circ C$
Gate resistance	$R_G$	-	14	-	$\Omega$	$f=1MHz, \text{open drain}$

**Table 5 Dynamic characteristics**

Parameter	Symbol	Values			Unit	Note / Test Condition
		Min.	Typ.	Max.		
Input capacitance	$C_{iss}$	-	200	-	pF	$V_{GS}=0V, V_{DS}=100V, f=1MHz$
Output capacitance	$C_{oss}$	-	16	-	pF	$V_{GS}=0V, V_{DS}=100V, f=1MHz$
Effective output capacitance, energy related <sup>1)</sup>	$C_{o(er)}$	-	11	-	pF	$V_{GS}=0V, V_{DS}=0...480V$
Effective output capacitance, time related <sup>2)</sup>	$C_{o(tr)}$	-	41.3	-	pF	$I_D=\text{constant}, V_{GS}=0V, V_{DS}=0...480V$
Turn-on delay time	$t_{d(on)}$	-	8	-	ns	$V_{DD}=400V, V_{GS}=10V, I_D=1.4A,$ $R_G=12.2\Omega; \text{see table 10}$
Rise time	$t_r$	-	7	-	ns	$V_{DD}=400V, V_{GS}=10V, I_D=1.4A,$ $R_G=12.2\Omega; \text{see table 10}$
Turn-off delay time	$t_{d(off)}$	-	40	-	ns	$V_{DD}=400V, V_{GS}=10V, I_D=1.4A,$ $R_G=12.2\Omega; \text{see table 10}$
Fall time	$t_f$	-	20	-	ns	$V_{DD}=400V, V_{GS}=10V, I_D=1.4A,$ $R_G=12.2\Omega; \text{see table 10}$

**Table 6 Gate charge characteristics**

Parameter	Symbol	Values			Unit	Note / Test Condition
		Min.	Typ.	Max.		
Gate to source charge	$Q_{GS}$	-	1.1	-	nC	$V_{DD}=480V, I_D=1.4A, V_{GS}=0 \text{ to } 10V$
Gate to drain charge	$Q_{gd}$	-	5	-	nC	$V_{DD}=480V, I_D=1.4A, V_{GS}=0 \text{ to } 10V$
Gate charge total	$Q_g$	-	9.4	-	nC	$V_{DD}=480V, I_D=1.4A, V_{GS}=0 \text{ to } 10V$
Gate plateau voltage	$V_{plateau}$	-	5.4	-	V	$V_{DD}=480V, I_D=1.4A, V_{GS}=0 \text{ to } 10V$

<sup>1)</sup>  $C_{o(er)}$  is a fixed capacitance that gives the same stored energy as  $C_{oss}$  while  $V_{DS}$  is rising from 0 to 80%  $V_{(BR)DSS}$

<sup>2)</sup>  $C_{o(tr)}$  is a fixed capacitance that gives the same stored energy as  $C_{oss}$  while  $V_{DS}$  is rising from 0 to 80%  $V_{(BR)DSS}$

**Table 7 Reverse diode characteristics**

Parameter	Symbol	Values			Unit	Note / Test Condition
		Min.	Typ.	Max.		
Diode forward voltage	$V_{SD}$	-	0.9	-	V	$V_{GS}=0V, I_F=1.4A, T_j=25^\circ C$
Reverse recovery time	$t_{rr}$	-	230	-	ns	$V_R=400V, I_F=1.4A, di_F/dt=100A/\mu s$ ; see table 9
Reverse recovery charge	$Q_{rr}$	-	1.1	-	$\mu C$	$V_R=400V, I_F=1.4A, di_F/dt=100A/\mu s$ ; see table 9
Peak reverse recovery current	$I_{rrm}$	-	9.8	-	A	$V_R=400V, I_F=1.4A, di_F/dt=100A/\mu s$ ; see table 9

### 4 Electrical characteristics diagrams

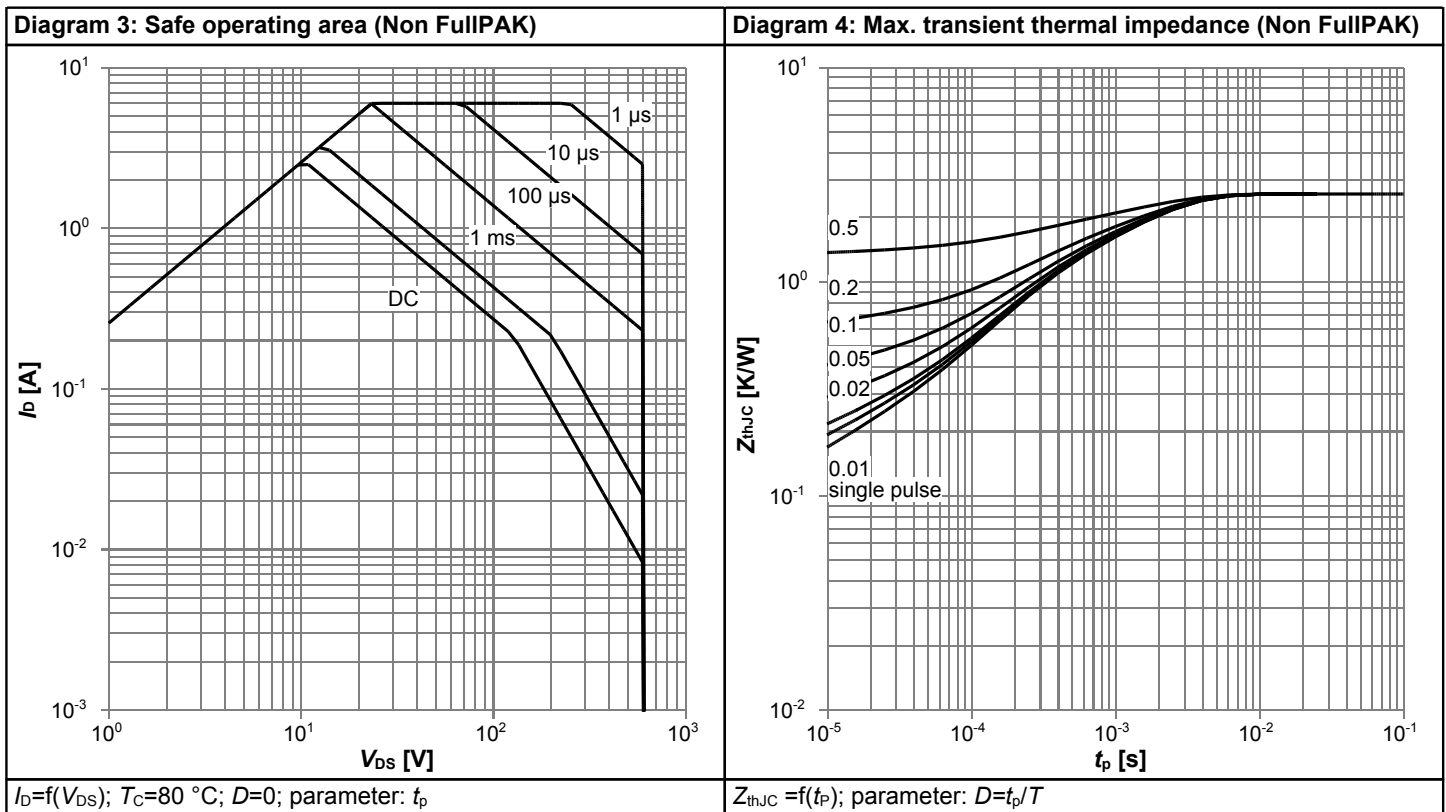
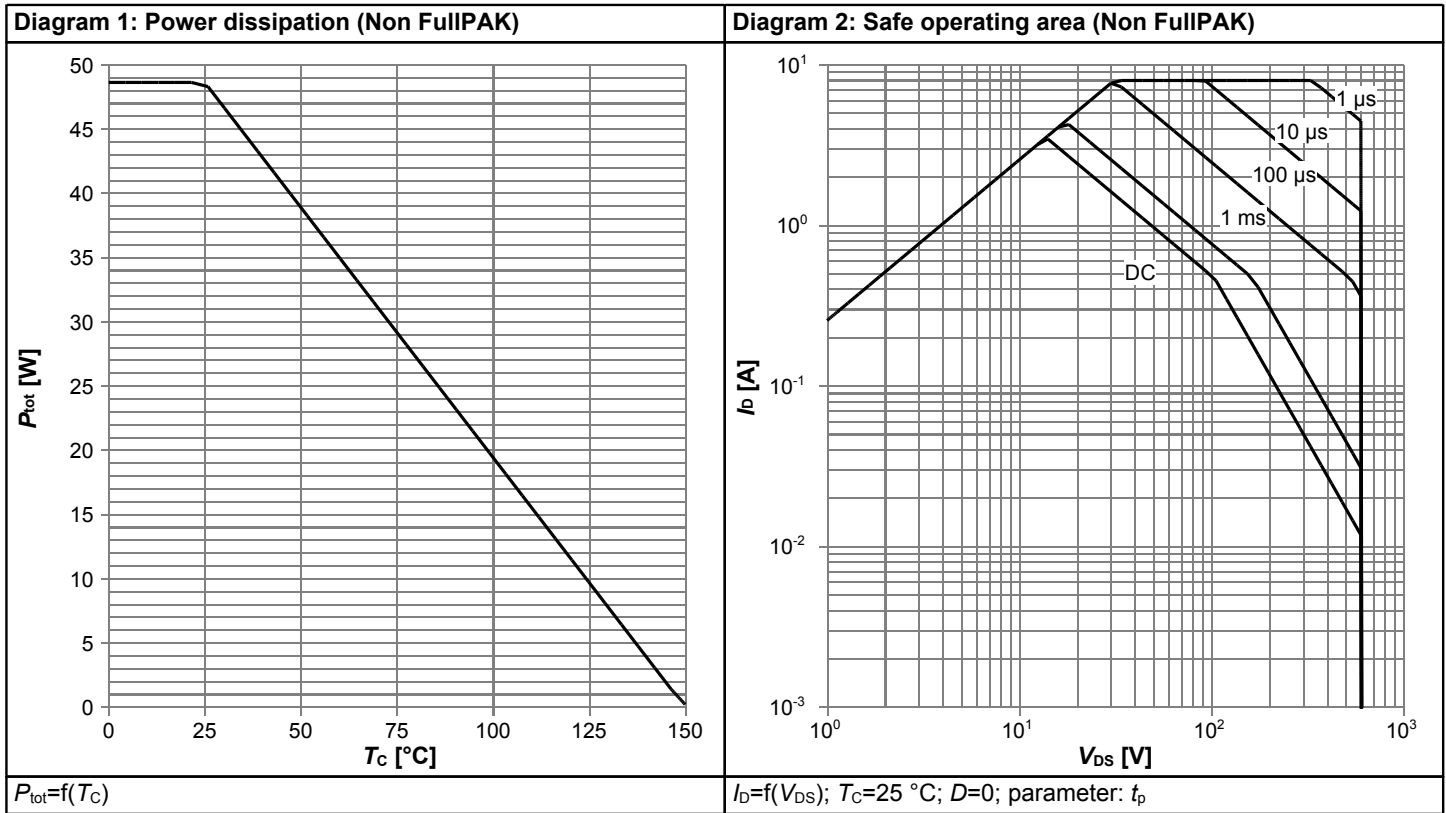

# 600V CoolMOS™ CE Power Transistor

IPD60R1K5CE, IPU60R1K5CE

Diagram 5: Typ. output characteristics

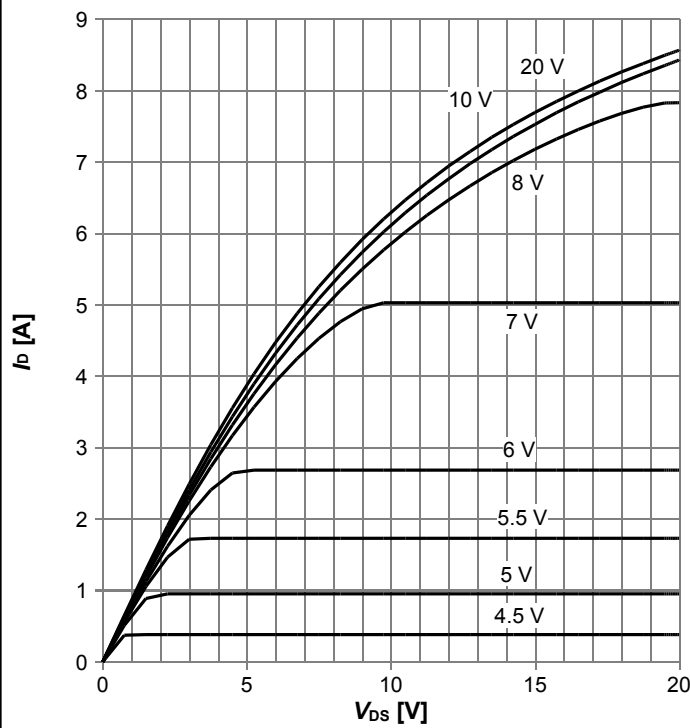

$I_D=f(V_{DS})$ ;  $T_j=25\text{ }^\circ\text{C}$ ; parameter:  $V_{GS}$

Diagram 6: Typ. output characteristics

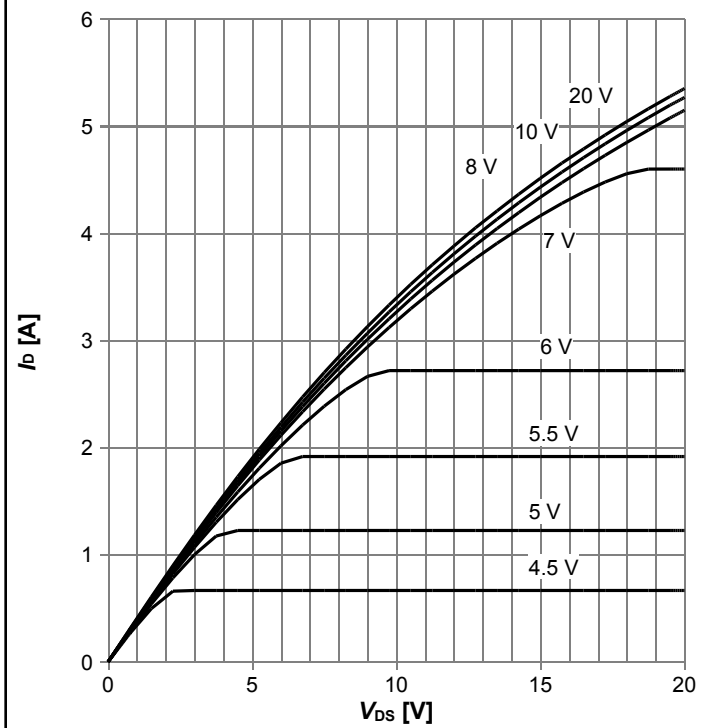

$I_D=f(V_{DS})$ ;  $T_j=125\text{ }^\circ\text{C}$ ; parameter:  $V_{GS}$

Diagram 7: Typ. drain-source on-state resistance

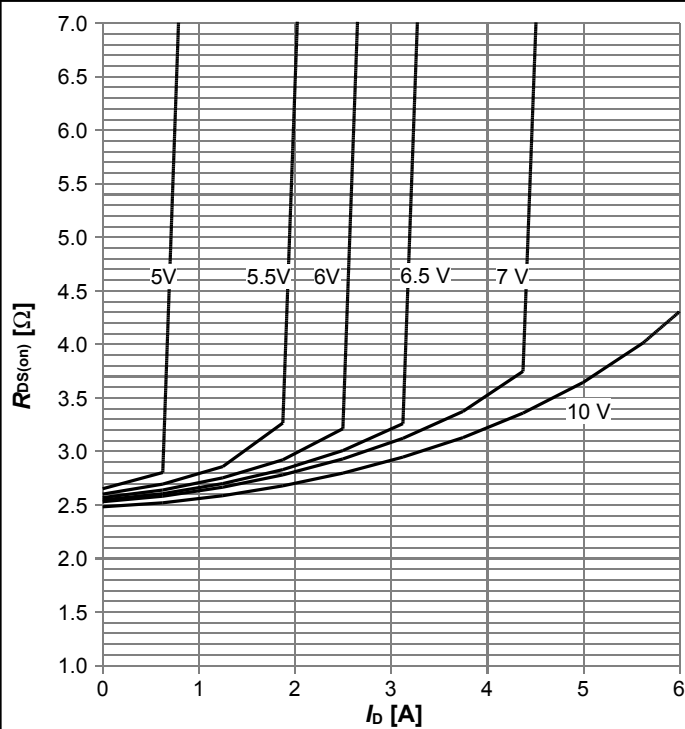

$R_{DS(on)}=f(I_D)$ ;  $T_j=125\text{ }^\circ\text{C}$ ; parameter:  $V_{GS}$

Diagram 8: Drain-source on-state resistance

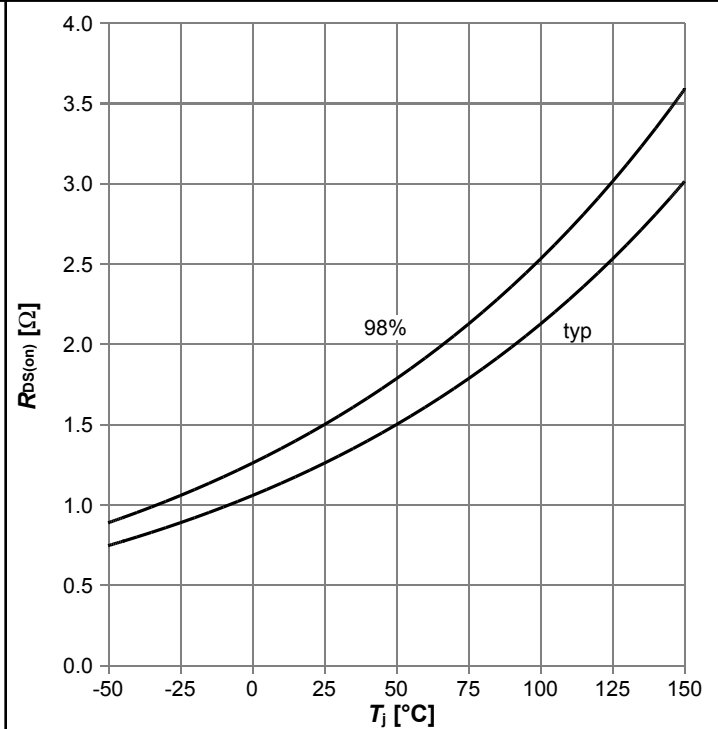

$R_{DS(on)}=f(T_j)$ ;  $I_D=1.1\text{ A}$ ;  $V_{GS}=10\text{ V}$

# 600V CoolMOS™ CE Power Transistor

IPD60R1K5CE, IPU60R1K5CE

**Diagram 9: Typ. transfer characteristics**

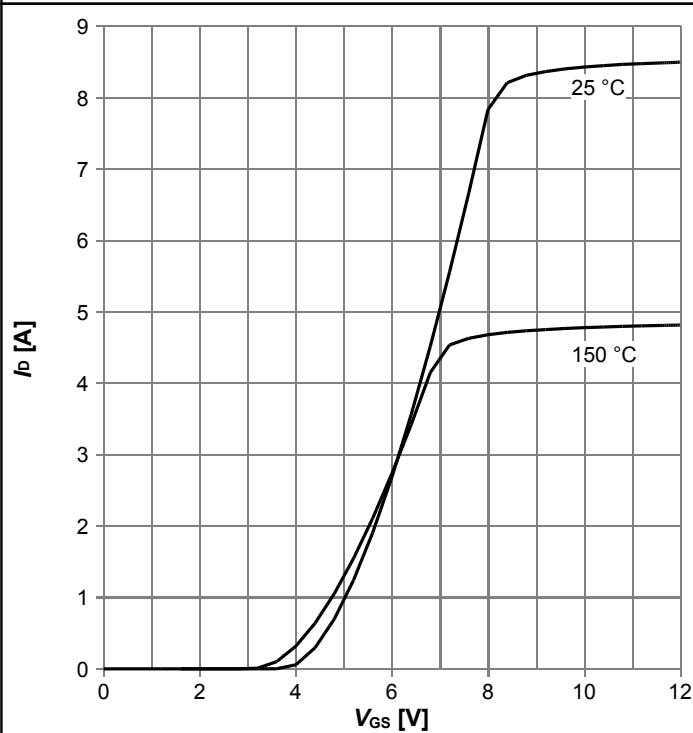

$I_D = f(V_{GS}); V_{DS} = 20V; \text{parameter: } T_j$

**Diagram 10: Typ. gate charge**

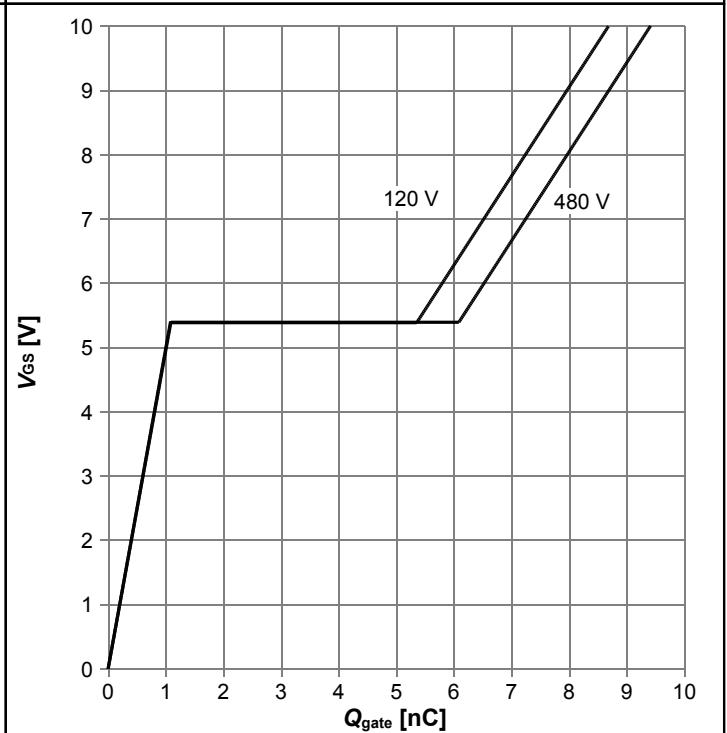

$V_{GS} = f(Q_{gate}); I_D = 1.4 \text{ A pulsed}; \text{parameter: } V_{DD}$

**Diagram 11: Forward characteristics of reverse diode**

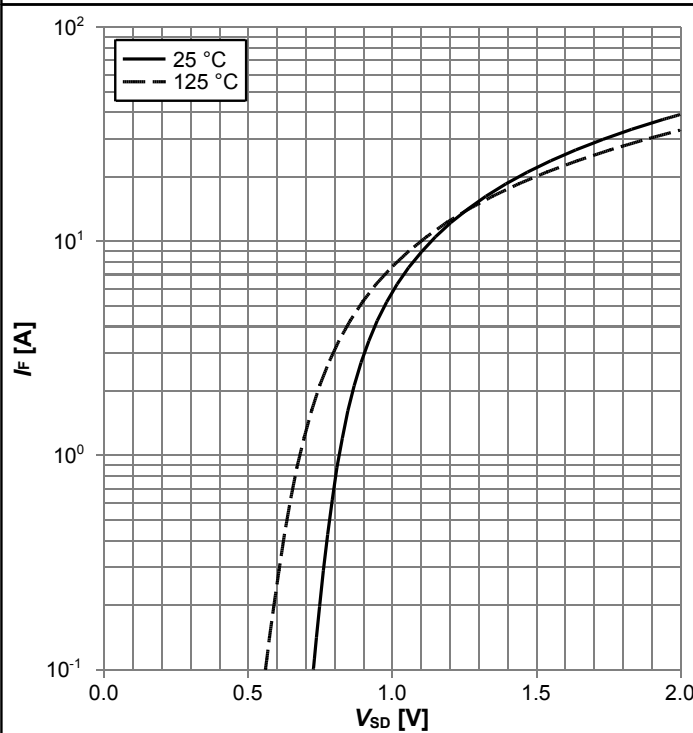

$I_F = f(V_{SD}); \text{parameter: } T_j$

**Diagram 12: Avalanche energy**

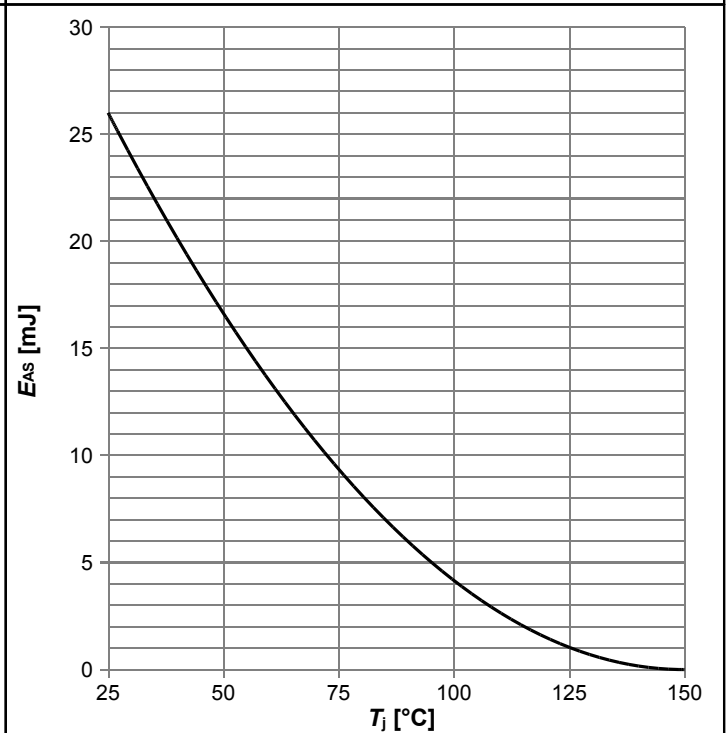

$E_{AS} = f(T_j); I_D = 0.6 \text{ A}; V_{DD} = 50 \text{ V}$



**600V CoolMOS™ CE Power Transistor**  
**IPD60R1K5CE, IPU60R1K5CE**

**Diagram 13: Drain-source breakdown voltage**

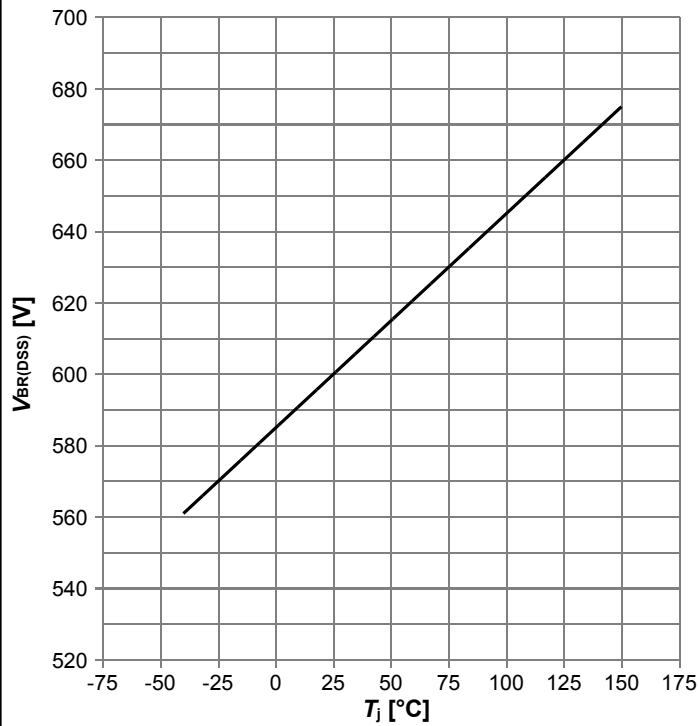

$V_{BR(DSS)}=f(T_j); I_D=0.25 \text{ mA}$

**Diagram 14: Typ. capacitances**

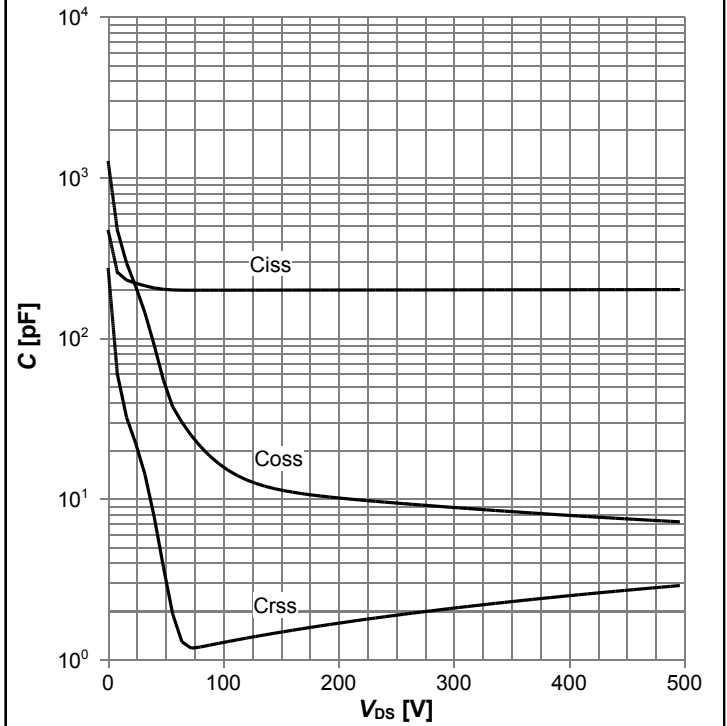

$C=f(V_{DS}); V_{GS}=0 \text{ V}; f=1 \text{ MHz}$

**Diagram 15: Typ. Coss stored energy**

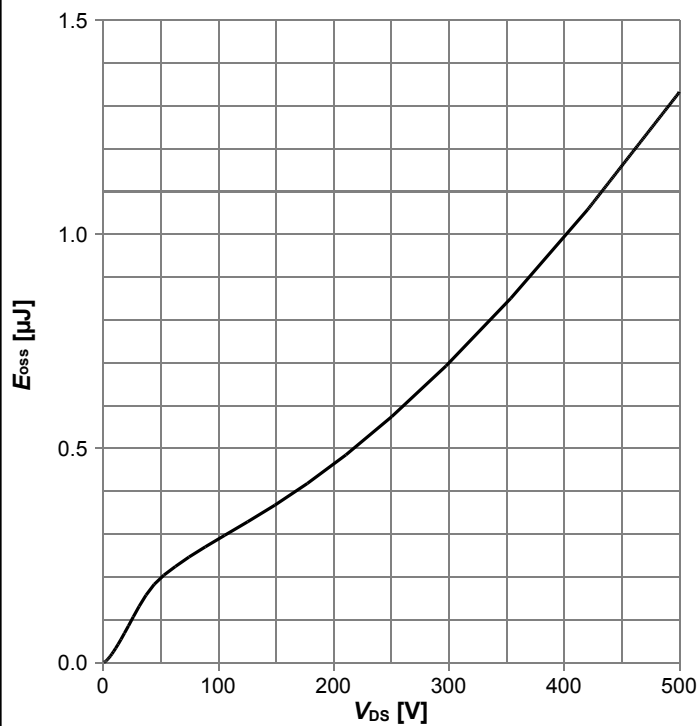

$E_{oss}=f(V_{DS})$

## 5 Test Circuits

**Table 8 Diode characteristics**

Test circuit for diode characteristics	Diode recovery waveform
<p><math>R_{g1} = R_{g2}</math></p>	<p><math>t_{rr} = t_F + t_S</math>  <math>Q_{rr} = Q_F + Q_S</math></p>

**Table 9 Switching times**

Switching times test circuit for inductive load	Switching times waveform

**Table 10 Unclamped inductive load**

Unclamped inductive load test circuit	Unclamped inductive waveform

## 6 Package Outlines

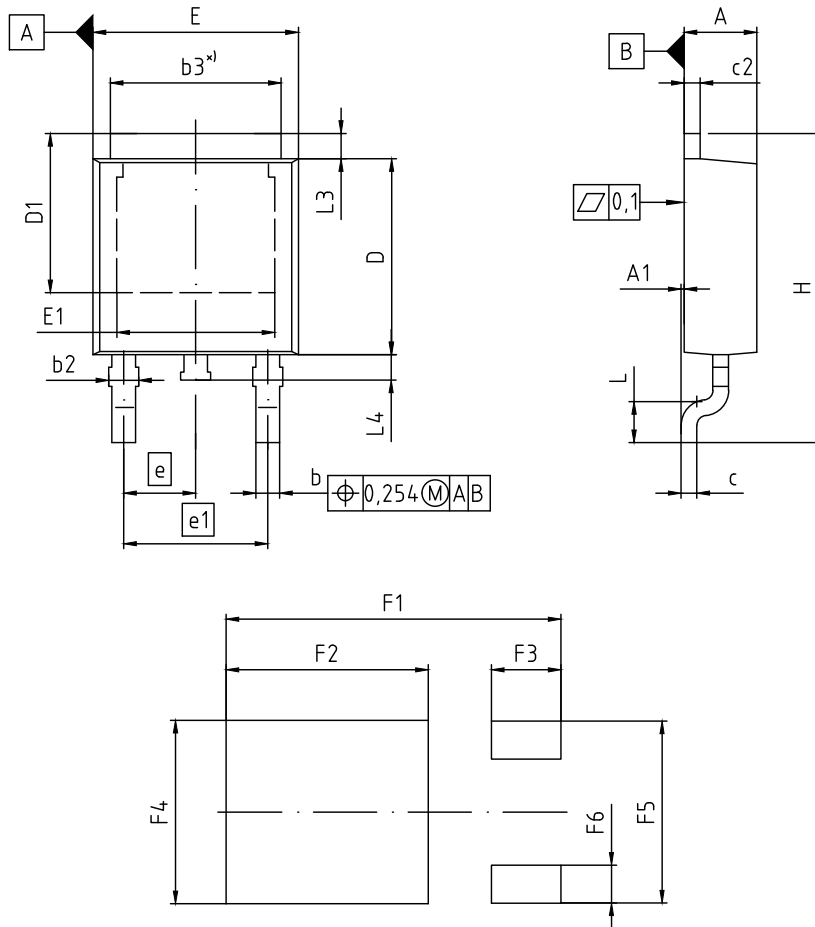

\*) mold flash not included

DIM	MILLIMETERS		INCHES	
	MIN	MAX	MIN	MAX
A	2.16	2.41	0.085	0.095
A1	0.00	0.15	0.000	0.006
b	0.64	0.89	0.025	0.035
b2	0.65	1.15	0.026	0.045
b3	5.00	5.50	0.197	0.217
c	0.46	0.60	0.018	0.024
c2	0.46	0.98	0.018	0.039
D	5.97	6.22	0.235	0.245
D1	5.02	5.84	0.198	0.230
E	6.40	6.73	0.252	0.265
E1	4.70	5.60	0.185	0.220
e	2.29 (BSC)		0.090 (BSC)	
e1	4.57 (BSC)		0.180 (BSC)	
N	3		3	
H	9.40	10.48	0.370	0.413
L	1.18	1.70	0.046	0.067
L3	0.90	1.25	0.035	0.049
L4	0.51	1.00	0.020	0.039
F1	10.60		0.417	
F2	6.40		0.252	
F3	2.20		0.087	
F4	5.80		0.228	
F5	5.76		0.227	
F6	1.20		0.047	

<b>DOCUMENT NO.</b> Z8B00003328
<b>SCALE</b> 0 2.0 4mm
<b>EUROPEAN PROJECTION</b> 
<b>ISSUE DATE</b> 01-09-2015
<b>REVISION</b> 05

**Figure 1 Outline PG-TO 252, dimensions in mm/inches**

**600V CoolMOS™ CE Power Transistor**  
**IPD60R1K5CE, IPU60R1K5CE**

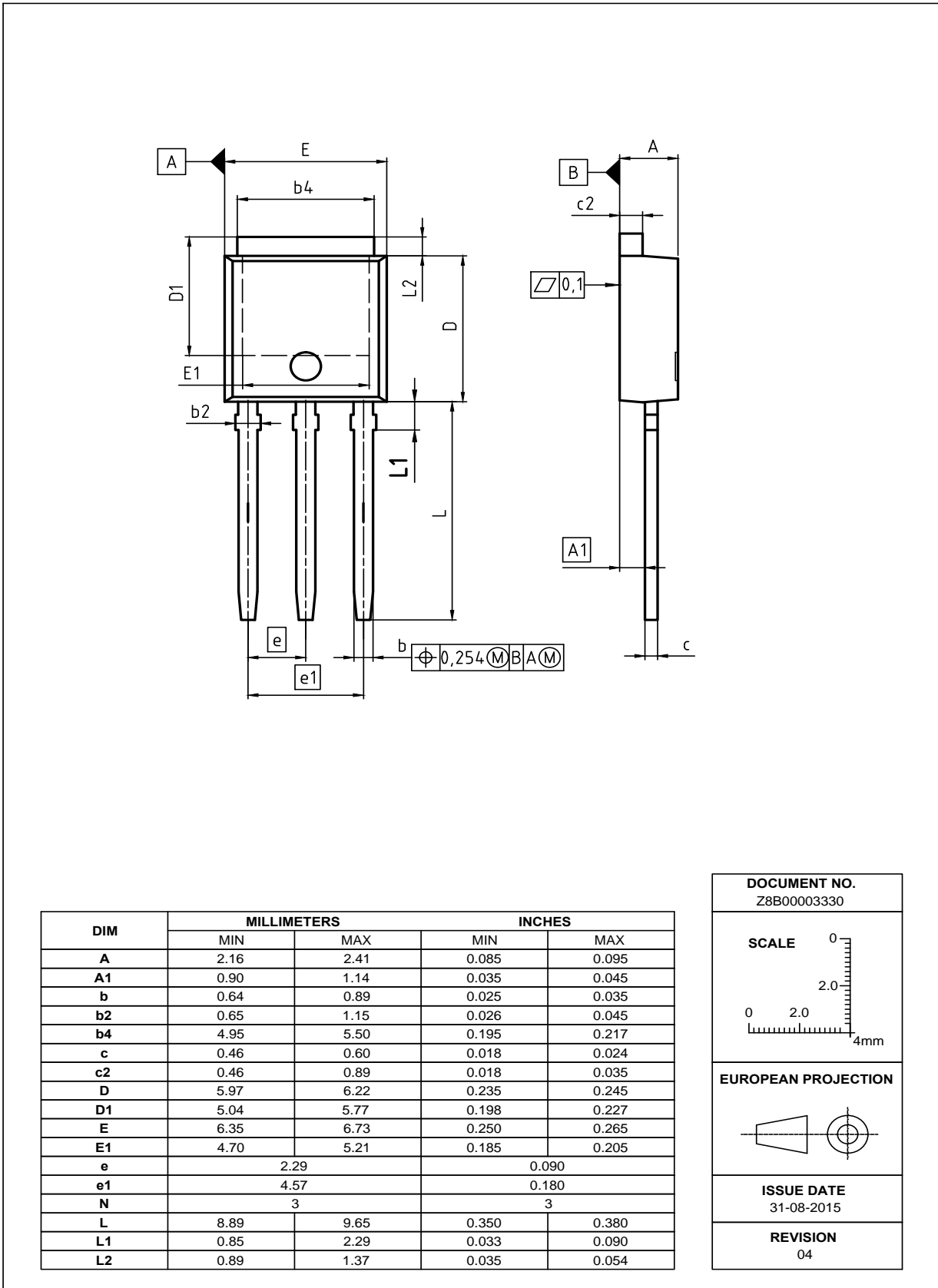

**Figure 2 Outline PG-TO 251, dimensions in mm/inches**

## 7 Appendix A

### Table 11 Related Links

- IFX CoolMOS™ CE Webpage: [www.infineon.com](http://www.infineon.com)
- IFX CoolMOS™ CE application note: [www.infineon.com](http://www.infineon.com)
- IFX CoolMOS™ CE simulation model: [www.infineon.com](http://www.infineon.com)
- IFX Design tools: [www.infineon.com](http://www.infineon.com)

## Revision History

IPD60R1K5CE, IPU60R1K5CE

**Revision: 2016-03-31**

Previous Revision

Date	Subjects (major changes since last revision)
2014-09-25	Release of final version
2015-11-17	Updated to qualified for standard grade & updated package drawing
2016-03-31	Modified Id, Rthjc. Modified SOA, Zthjc curves

### Trademarks of Infineon Technologies AG

AURIX™, C166™, CanPAK™, CIPOS™, CoolGaN™, CoolMOS™, CoolSET™, CoolSiC™, CORECONTROL™, CROSSAVE™, DAVE™, DI-POL™, DrBlade™, EasyPIM™, EconoBRIDGE™, EconoDUAL™, EconoPACK™, EconoPIM™, EiceDRIVER™, eupec™, FCOS™, HITFET™, HybridPACK™, Infineon™, ISOFACE™, IsoPACK™, i-Wafer™, MIPAQ™, ModSTACK™, my-d™, NovalithIC™, OmniTune™, OPTIGA™, OptiMOS™, ORIGA™, POWERCODE™, PRIMARION™, PrimePACK™, PrimeSTACK™, PROFET™, PRO-SIL™, RASIC™, REAL3™, ReverSave™, SatRIC™, SIEGET™, SiPMOS™, SmartLEWIS™, SOLID FLASH™, SPOC™, TEMPFET™, thinQ!™, TRENCHSTOP™, TriCore™.

Trademarks updated August 2015

### Other Trademarks

All referenced product or service names and trademarks are the property of their respective owners.

### We Listen to Your Comments

Any information within this document that you feel is wrong, unclear or missing at all? Your feedback will help us to continuously improve the quality of this document. Please send your proposal (including a reference to this document) to: [erratum@infineon.com](mailto:erratum@infineon.com)

**Published by**  
**Infineon Technologies AG**  
**81726 München, Germany**  
**© 2016 Infineon Technologies AG**  
**All Rights Reserved.**

### Legal Disclaimer

The information given in this document shall in no event be regarded as a guarantee of conditions or characteristics. With respect to any examples or hints given herein, any typical values stated herein and/or any information regarding the application of the device, Infineon Technologies hereby disclaims any and all warranties and liabilities of any kind, including without limitation, warranties of non-infringement of intellectual property rights of any third party.

### Information

For further information on technology, delivery terms and conditions and prices please contact your nearest Infineon Technologies Office ([www.infineon.com](http://www.infineon.com)).

### Warnings

Due to technical requirements, components may contain dangerous substances. For information on the types in question, please contact the nearest Infineon Technologies Office.

The Infineon Technologies component described in this Data Sheet may be used in life-support devices or systems and/or automotive, aviation and aerospace applications or systems only with the express written approval of Infineon Technologies, if a failure of such components can reasonably be expected to cause the failure of that life-support, automotive, aviation and aerospace device or system or to affect the safety or effectiveness of that device or system. Life support devices or systems are intended to be implanted in the human body or to support and/or maintain and sustain and/or protect human life. If they fail, it is reasonable to assume that the health of the user or other persons may be endangered.