

**OptiMOS™ -5 Power Transistor**

**Features**

- OptiMOS™ power MOSFET for automotive applications
- N-channel - Enhancement mode - Logic level
- MSL1 up to 260°C peak reflow
- 175 °C operating temperature
- Green product (RoHS compliant)
- 100% Avalanche tested

**Product Summary**

$V_{DS}$	60	V
$R_{DS(on),max}$	3.2	mΩ
$I_D$	120	A

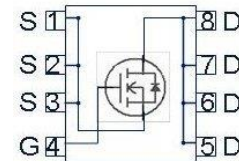
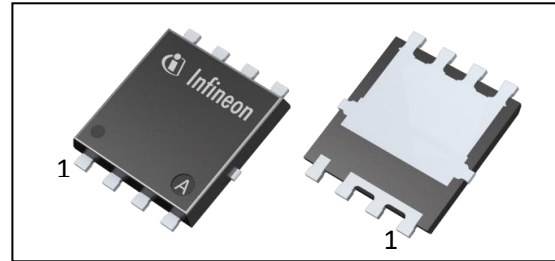
**PG-TDSON-8-34**

Type	Package	Marking
IAUC120N06S5L032	<a href="#">PG-TDSON-8-34</a>	5N06L032

**Maximum ratings, at  $T_j=25\text{ °C}$ , unless otherwise specified**

Parameter	Symbol	Conditions	Value	Unit
Drain current	$I_D$	$V_{GS}=10\text{ V}$ , Chip limitation <sup>1,2)</sup>	129	A
		$V_{GS}=10\text{ V}$ , DC current <sup>3)</sup>	120	
		$T_a=85\text{ °C}$ , $V_{GS}=10\text{ V}$ , $R_{thJA}$ on 2s2p <sup>2,4)</sup>	21	
Pulsed drain current <sup>2)</sup>	$I_{D,pulse}$	$T_C=25\text{ °C}$ , $t_p=100\text{ }\mu\text{s}$	364	
Avalanche energy, single pulse <sup>2)</sup>	$E_{AS}$	$I_D=60\text{ A}$	92	mJ
Avalanche current, single pulse	$I_{AS}$	-	100	A
Gate source voltage	$V_{GS}$	-	$\pm 16$	V
Power dissipation	$P_{tot}$	$T_C=25\text{ °C}$	94	W
Operating and storage temperature	$T_j, T_{stg}$	-	-55 ... +175	°C

Parameter	Symbol	Conditions	Values			Unit
			min.	typ.	max.	
<b>Thermal characteristics<sup>2)</sup></b>						
Thermal resistance, junction - case	$R_{thJC}$	-	-	-	1.6	K/W
Thermal resistance, junction - ambient <sup>4)</sup>	$R_{thJA}$	-	-	24.2	-	
<b>Electrical characteristics, at <math>T_j=25^\circ\text{C}</math>, unless otherwise specified</b>						
<b>Static characteristics</b>						
Drain-source breakdown voltage	$V_{(BR)DSS}$	$V_{GS}=0V, I_D=1mA$	60	-	-	V
Gate threshold voltage	$V_{GS(th)}$	$V_{DS}=V_{GS}, I_D=44\mu A$	1.2	1.7	2.2	
Zero gate voltage drain current	$I_{DSS}$	$V_{DS}=60V, V_{GS}=0V, T_j=25^\circ\text{C}$	-	-	1	$\mu A$
		$V_{DS}=60V, V_{GS}=0V, T_j=125^\circ\text{C}^{1)}$	-	-	100	
Gate-source leakage current	$I_{GSS}$	$V_{GS}=16V, V_{DS}=0V$	-	-	100	nA
Drain-source on-state resistance	$R_{DS(on)}$	$V_{GS}=4.5V, I_D=60A$	-	3.6	4.4	m $\Omega$
		$V_{GS}=10V, I_D=60A$	-	2.5	3.2	
Gate resistance <sup>2)</sup>	$R_G$	-	-	1.2	-	$\Omega$

Parameter	Symbol	Conditions	Values			Unit
			min.	typ.	max.	

**Dynamic characteristics<sup>2)</sup>**

Input capacitance	$C_{iss}$	$V_{GS}=0V, V_{DS}=30V,$ $f=1MHz$	-	2941	3823	pF
Output capacitance	$C_{oss}$		-	557	725	
Reverse transfer capacitance	$C_{rss}$		-	24	36	
Turn-on delay time	$t_{d(on)}$	$V_{DD}=30V, V_{GS}=10V,$ $I_D=60A, R_{G,ext}=3.5\Omega$	-	3.6	-	ns
Turn-off delay time	$t_{d(off)}$		-	20.0	-	
Rise time	$t_r$		-	1.0	-	
Fall time	$t_f$		-	8.0	-	

**Gate Charge Characteristics<sup>2)</sup>**

Gate to source charge	$Q_{gs}$	$V_{DD}=30V, I_D=60A,$ $V_{GS}=0$ to 10V	-	9.5	12.4	nC
Gate to drain charge	$Q_{gd}$		-	6.1	9.2	
Gate charge total	$Q_g$		-	39.6	51.5	
Gate plateau voltage	$V_{plateau}$		-	3.2	-	V

**Reverse Diode**

Diode continuous forward current <sup>2)</sup>	$I_S$	$T_C=25^\circ C$	-	-	120	A
Diode pulse current <sup>2)</sup>	$I_{S,pulse}$	$T_C=25^\circ C, t_p=100\mu s$	-	-	364	
Diode forward voltage	$V_{SD}$	$V_{GS}=0V, I_F=60A,$ $T_j=25^\circ C$	-	0.8	1.1	V
Reverse recovery time <sup>2)</sup>	$t_{rr}$	$V_R=30V, I_F=50A,$ $di_F/dt=100A/\mu s$	-	40	-	ns
Reverse recovery charge <sup>2)</sup>	$Q_{rr}$		-	38	-	nC

<sup>1)</sup> Practically the current is limited by the overall system design including the customer-specific PCB.

<sup>2)</sup> The parameter is not subject to production test - verified by design/characterization.

<sup>3)</sup> The product can operate at a specified current based on best practice to minimize electromigration at the solder joint. For rare events and inrush currents, the value may be exceeded.

<sup>4)</sup> Device on a four-layer 2s2p FR4 PCB defined in accordance with JEDEC standards (JESD51-5-7). PCB is vertical in still air.

### 1 Power dissipation

$$P_{\text{tot}} = f(T_C); V_{\text{GS}} = 10 \text{ V}$$

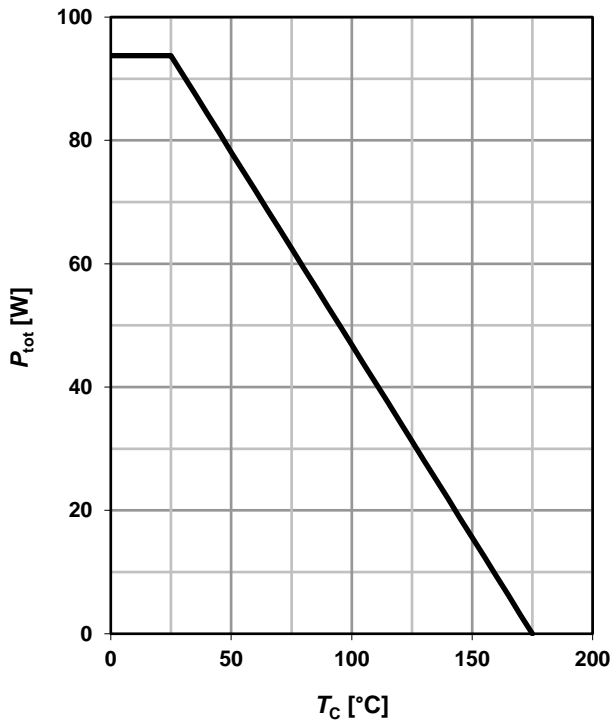

### 2 Drain current

$$I_D = f(T_C); V_{\text{GS}} = 10 \text{ V}$$

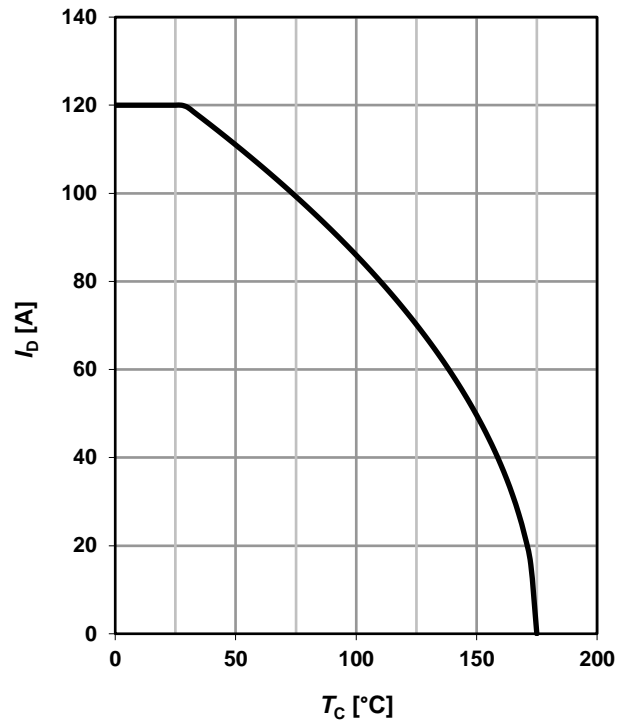

### 3 Safe operating area

$$I_D = f(V_{\text{DS}}); T_C = 25 \text{ °C}; D = 0$$

parameter:  $t_p$

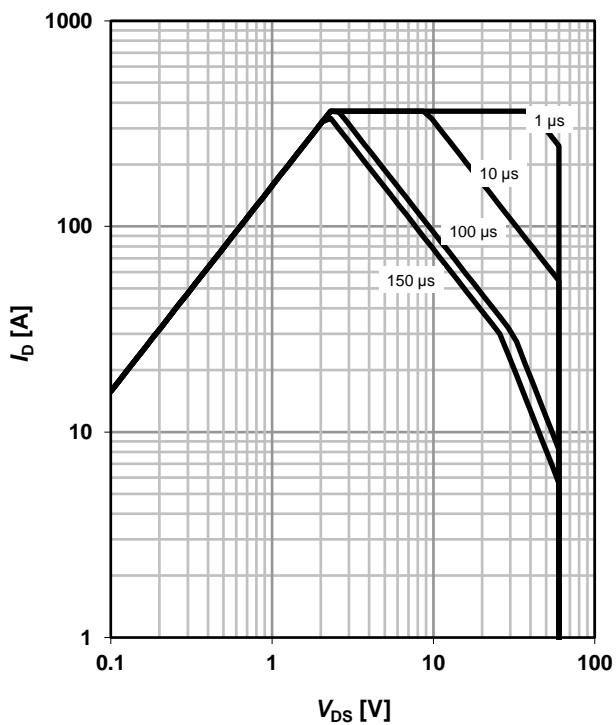

### 4 Max. transient thermal impedance

$$Z_{\text{thJC}} = f(t_p)$$

parameter:  $D = t_p/T$

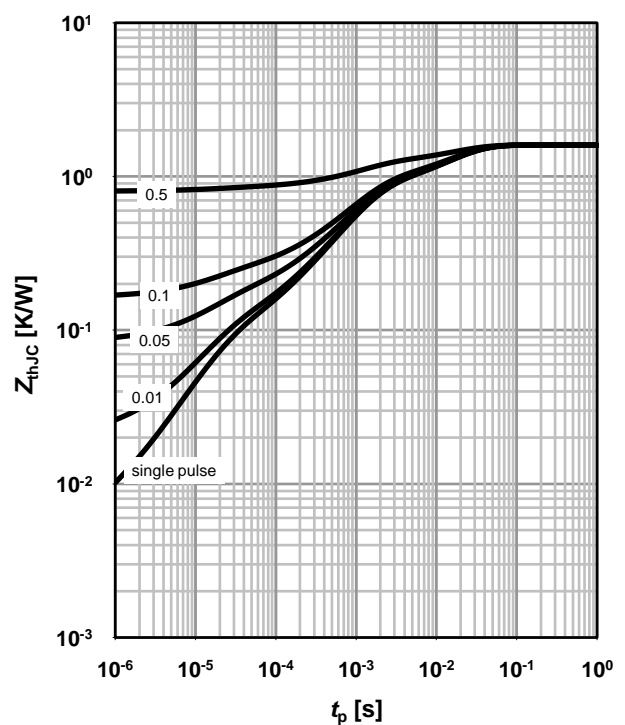

**5 Typ. output characteristics**

$I_D = f(V_{DS}); T_j = 25\text{ }^\circ\text{C}$

parameter:  $V_{GS}$

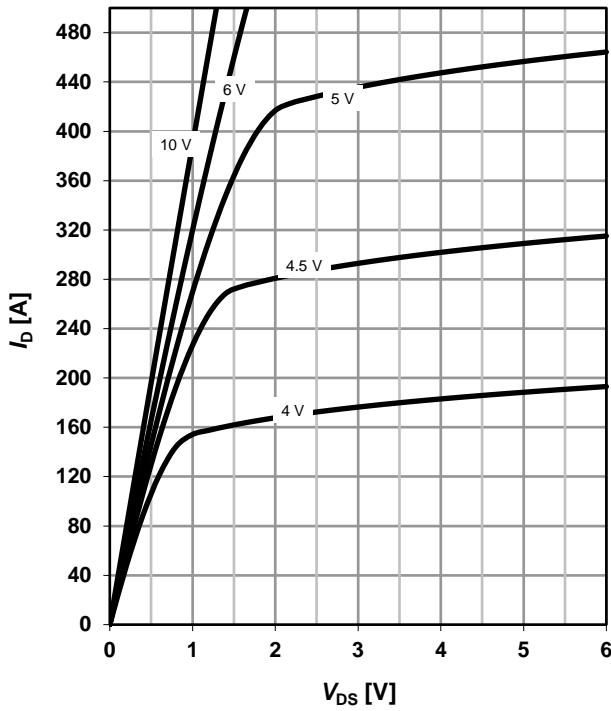

**6 Typ. drain-source on-state resistance**

$R_{DS(on)} = f(I_D); T_j = 25\text{ }^\circ\text{C}$

parameter:  $V_{GS}$

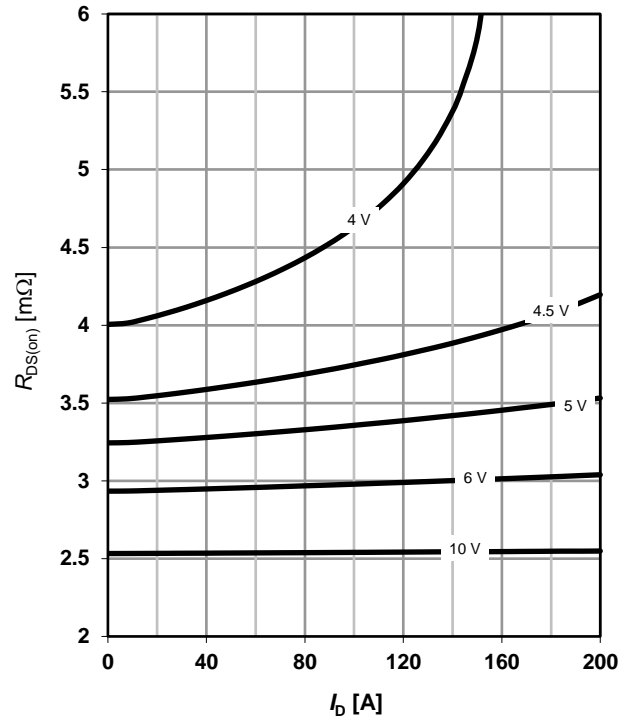

**7 Typ. transfer characteristics**

$I_D = f(V_{GS}); V_{DS} = 6\text{ V}$

parameter:  $T_j$

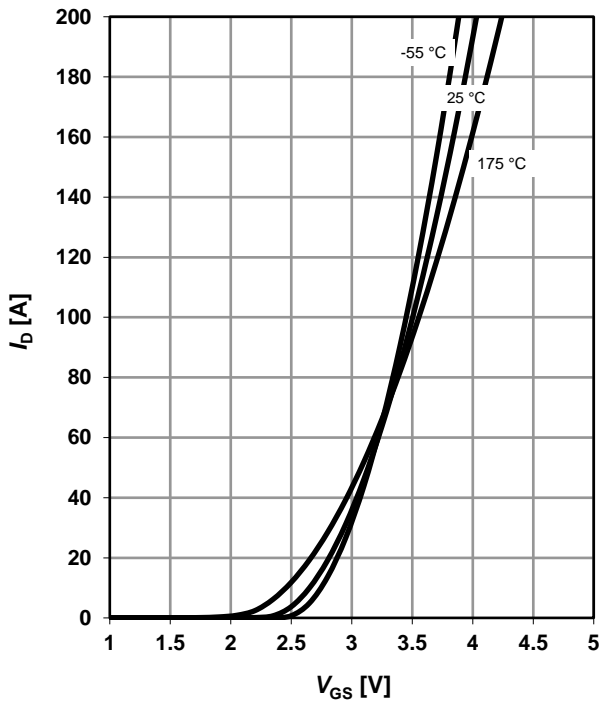

**8 Typ. drain-source on-state resistance**

$R_{DS(on)} = f(T_j);$

parameter:  $I_D, V_{GS}$

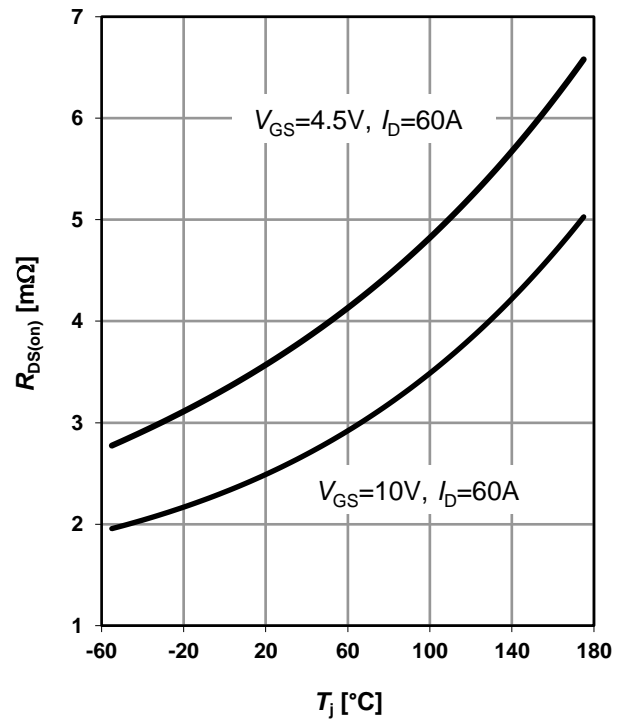

**9 Typ. gate threshold voltage**

$$V_{GS(th)} = f(T_j); V_{GS} = V_{DS}$$

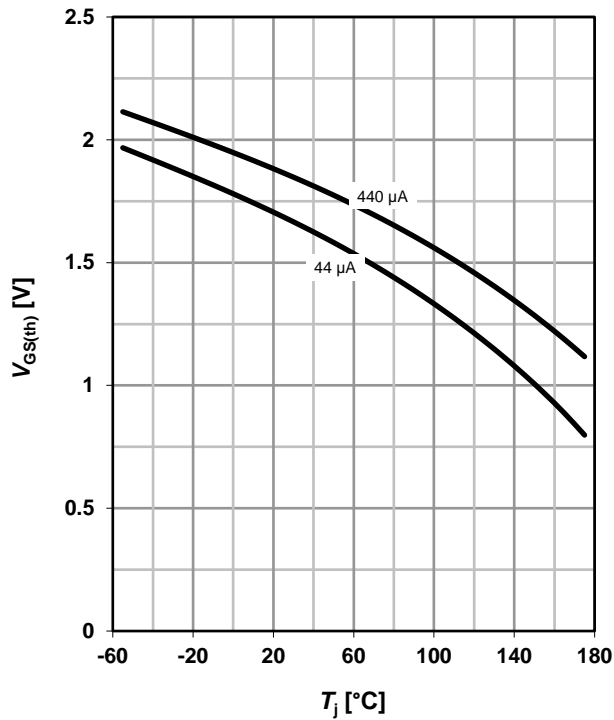
 parameter:  $I_D$ 

**10 Typ. capacitances**

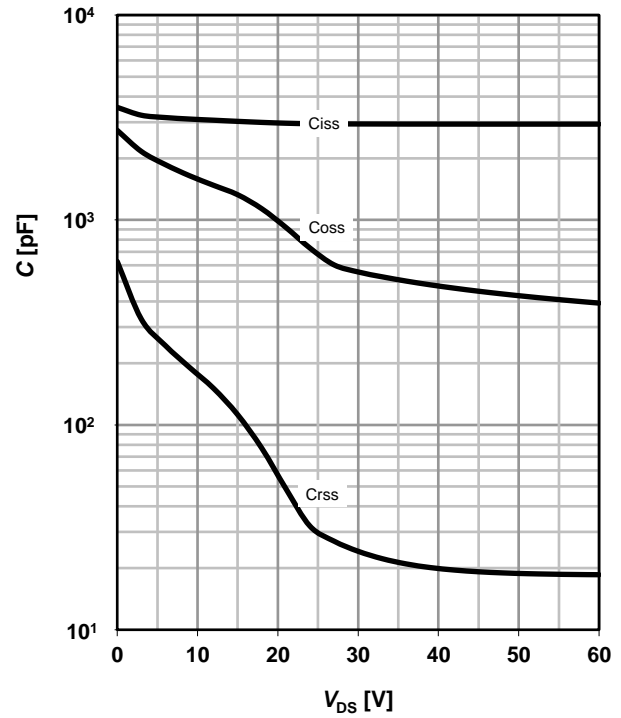
$$C = f(V_{DS}); V_{GS} = 0 \text{ V}; f = 1 \text{ MHz}$$

**11 Typical forward diode characteristics**

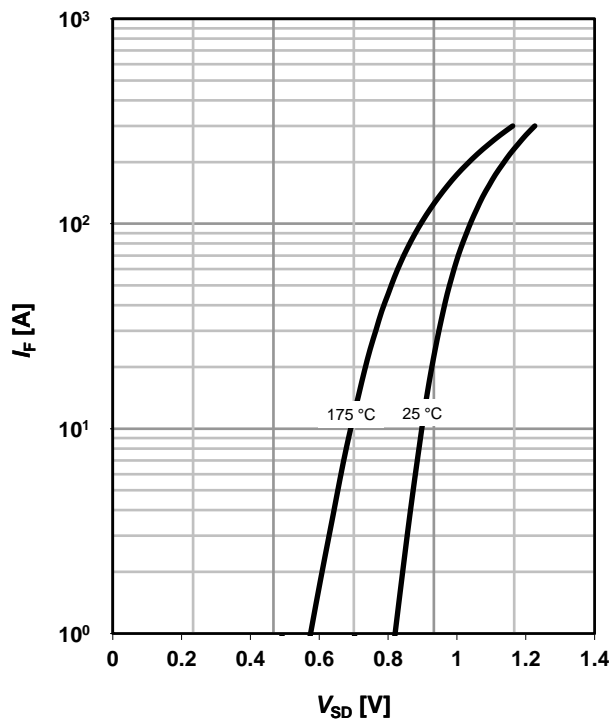
$$I_F = f(V_{SD})$$

 parameter:  $T_j$ 

**12 Avalanche characteristics**

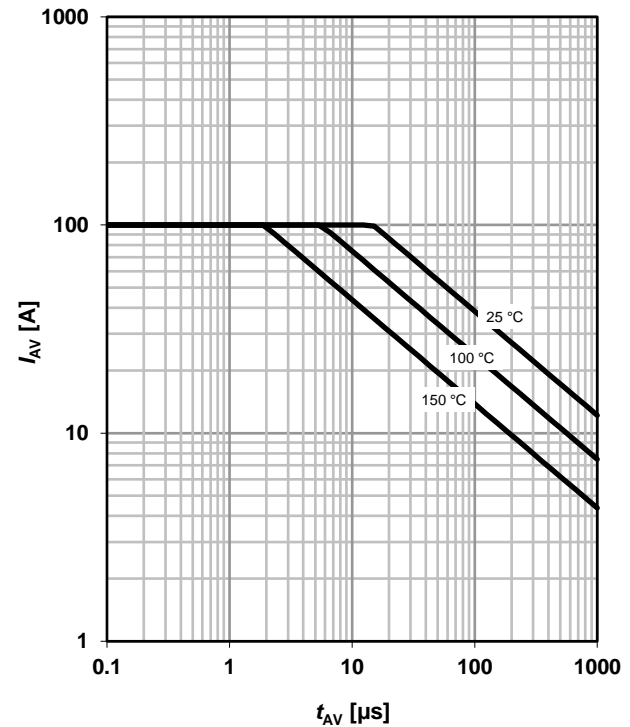
$$I_{AS} = f(t_{AV})$$

 parameter:  $T_{j(start)}$ 

### 13 Avalanche energy

$$E_{AS} = f(T_j)$$

parameter:  $I_D$

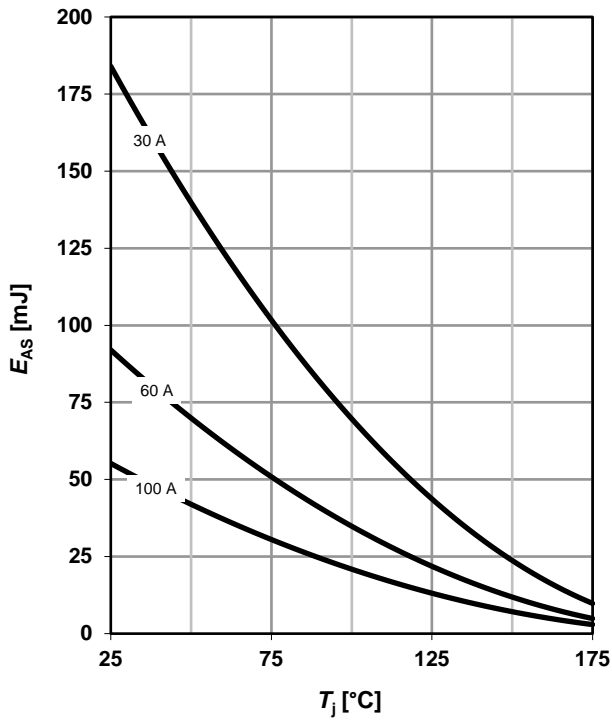

### 14 Drain-source breakdown voltage

$$V_{BR(DSS)} = f(T_j); I_D = 1 \text{ mA}$$

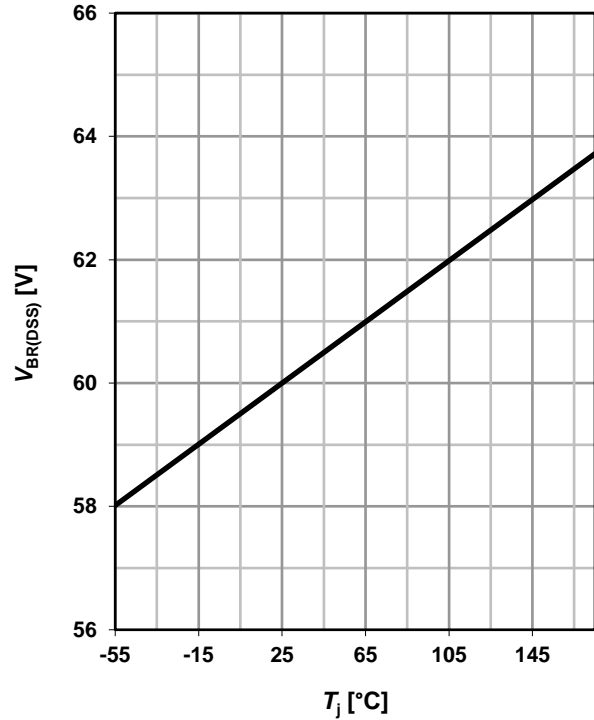

### 15 Typ. gate charge

$$V_{GS} = f(Q_{gate}); I_D = 60 \text{ A pulsed}$$

parameter:  $V_{DD}$

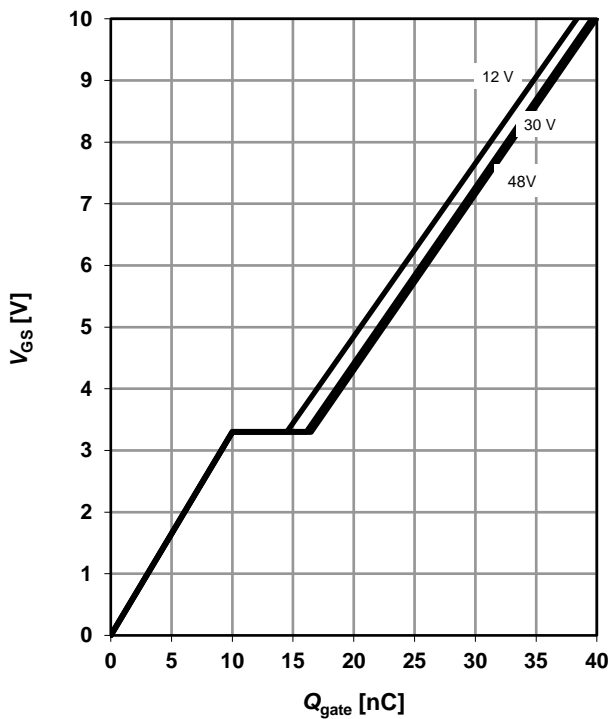

### 16 Gate charge waveforms

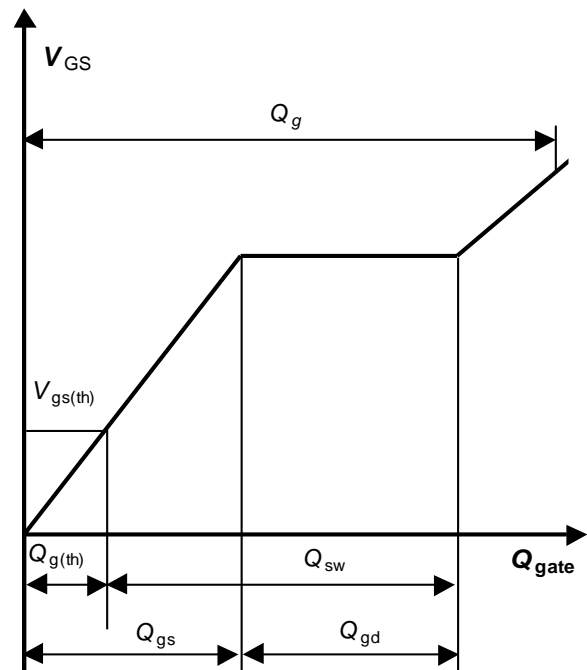

Package Outline

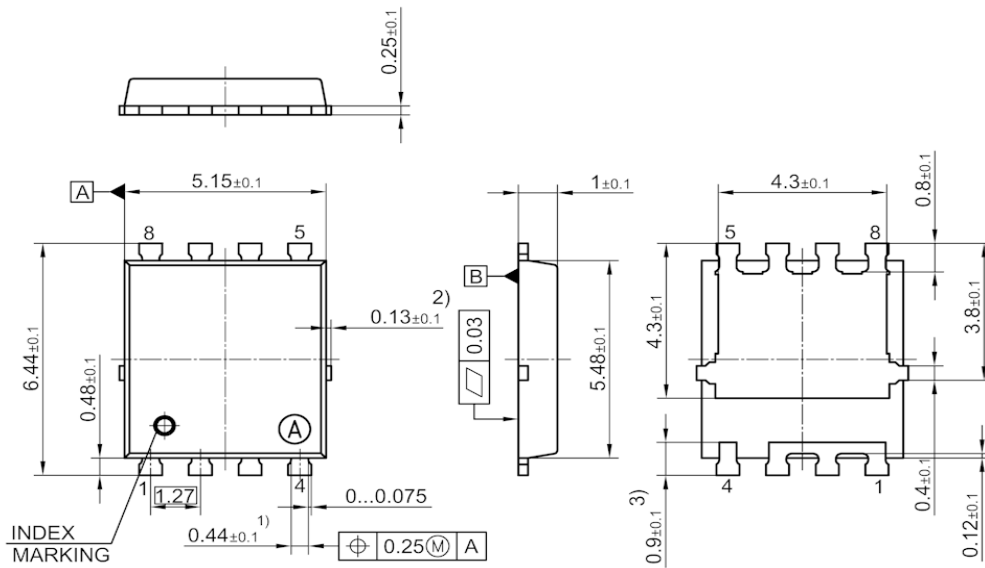

- 1) EXCLUDE MOLD FLASH
  - 2) REMOVAL ON MOLD GATE, INTRUSION 0.1MM AND PROTRUSION 0.1MM
  - 3) LEAD LENGTH UP TO ANTI FLASH LINE
  - 4) ALL METAL SURFACE ARE PLATED, EXCEPT AREA OF CUT
- ALL DIMENSIONS ARE IN UNITS MM  
 THE DRAWING IS IN COMPLIANCE WITH ISO 128 & PROJECTION METHOD 1 [ ]

Footprint

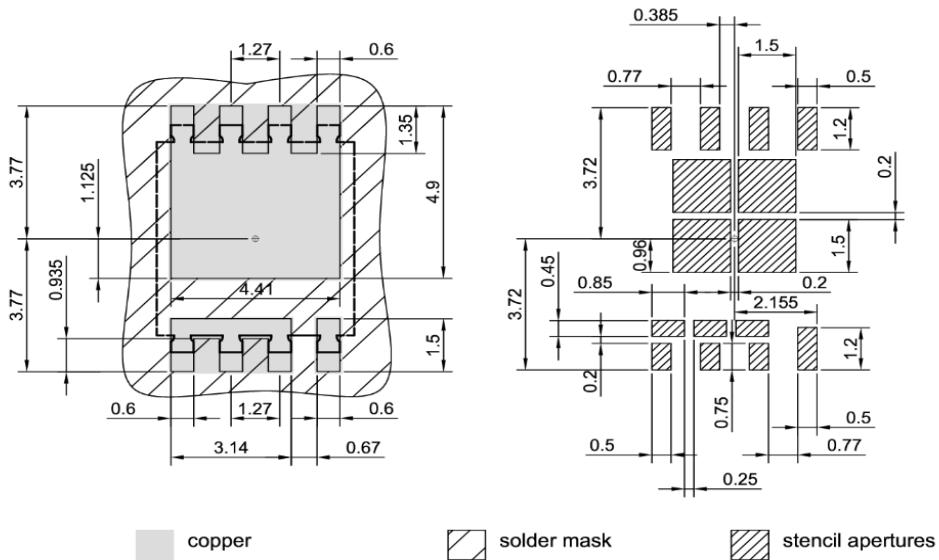

All dimensions are in units mm

Packaging

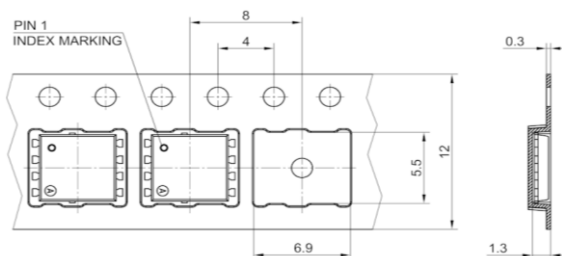



**Published by**  
**Infineon Technologies AG**  
**81726 Munich, Germany**

**© Infineon Technologies AG 2020**  
**All Rights Reserved.**

### **Legal Disclaimer**

The information given in this document shall in no event be regarded as a guarantee of conditions or characteristics. With respect to any examples or hints given herein, any typical values stated herein and/or any information regarding the application of the device, Infineon Technologies hereby disclaims any and all warranties and liabilities of any kind, including without limitation, warranties of non-infringement of intellectual property rights of any third party.

### **Information**

For further information on technology, delivery terms and conditions and prices, please contact the nearest Infineon Technologies Office ([www.infineon.com](http://www.infineon.com)).

### **Warnings**

Due to technical requirements, components may contain dangerous substances.  
For information on the types in question, please contact the nearest Infineon Technologies Office.  
Infineon Technologies components may be used in life-support devices or systems only with the express written approval of Infineon Technologies, if a failure of such components can reasonably be expected to cause the failure of that life-support device or system or to affect the safety or effectiveness of that device or system. Life support devices or systems are intended to be implanted in the human body or to support and/or maintain and sustain and/or protect human life.  
If they fail, it is reasonable to assume that the health of the user or other persons may be endangered.

---

Revision History

Version	Date	Changes
Revision 1.0	05.05.2020	Final Data Sheet