



## Features

- Output voltage  $5\text{ V} \pm 2\%$
- Very low current consumption
- Power-on and undervoltage reset
- Reset low down to  $V_Q = 1\text{ V}$
- Very low-drop voltage
- Short-circuit-proof
- Reverse polarity proof
- Suitable for use in automotive electronics
- ESD protection  $> 4\text{ kV}$
- Green Product (RoHS compliant) version of TLE 4275
- AEC qualified

## Functional Description

The TLE 4275 is a monolithic integrated low-drop voltage regulator in a 5-pin TO-package. An input voltage up to 45 V is regulated to  $V_{Q,nom} = 5.0\text{ V}$ . The IC is able to drive loads up to 450 mA and is short-circuit proof. At overtemperature the TLE 4275 is turned off by the incorporated temperature protection. A reset signal is generated for an output voltage  $V_{Q,rt}$  of typ. 4.65 V. The delay time can be programmed by the external delay capacitor.

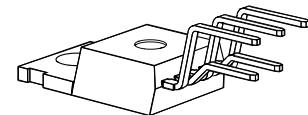

PG-TO220-5-11

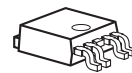

PG-TO252-11

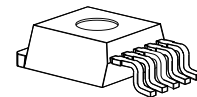

PG-TO263-5-1

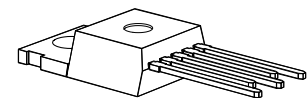

PG-TO220-5-12

Type	Package
TLE 4275	PG-TO220-5-11 (RoHS compliant)
TLE 4275 D	PG-TO252-5-11 (RoHS compliant)
TLE 4275 G	PG-TO263-5-1 (RoHS compliant)
TLE 4275 S	PG-TO220-5-12 (RoHS compliant)

### **Dimensioning Information on External Components**

The input capacitor  $C_I$  is necessary for compensation of line influences. Using a resistor of approx.  $1 \Omega$  in series with  $C_I$ , the oscillating of input inductivity and input capacitance can be damped. The output capacitor  $C_Q$  is necessary for the stability of the regulation circuit. Stability is guaranteed at values  $C_Q \geq 22 \mu\text{F}$  and an ESR of  $\leq 5 \Omega$  within the operating temperature range.

### **Circuit Description**

The control amplifier compares a reference voltage to a voltage that is proportional to the output voltage and drives the base of the series transistor via a buffer. Saturation control as a function of the load current prevents any oversaturation of the power element. The IC also incorporates a number of internal circuits for protection against:

- Overload
- Overtemperature
- Reverse polarity

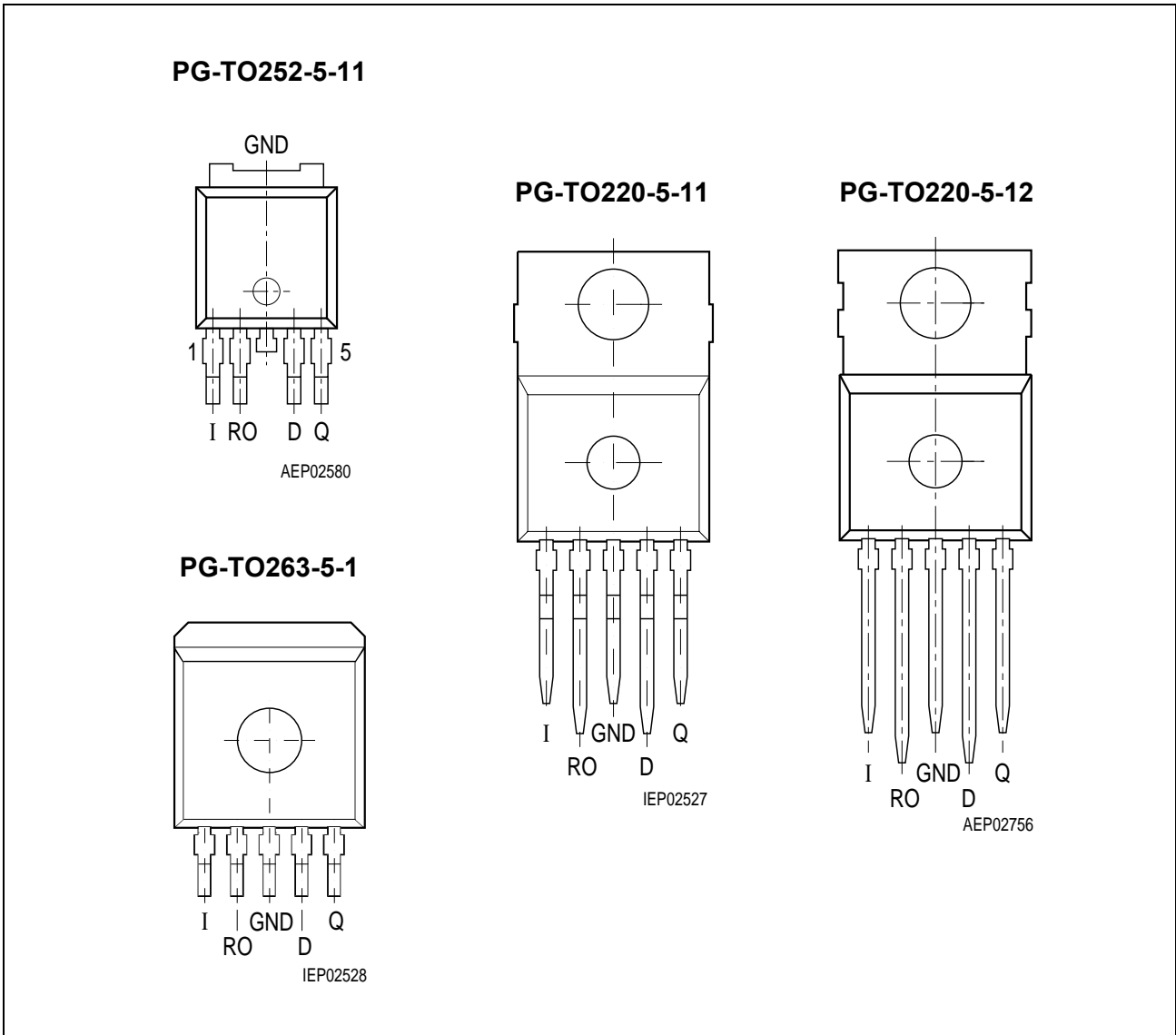

**Figure 1 Pin Configuration (top view)**

**Table 1 Pin Definitions and Functions**

Pin No.	Symbol	Function
1	I	<b>Input</b> ; block to ground directly at the IC by a ceramic capacitor.
2	RO	<b>Reset Output</b> ; open collector output
3	GND	<b>Ground</b> ; Pin 3 internally connected to heatsink
4	D	<b>Reset Delay</b> ; connect capacitor to GND for setting delay time
5	Q	<b>Output</b> ; block to ground with a $\geq 22 \mu\text{F}$ capacitor, ESR $< 5 \Omega$ at 10 kHz.

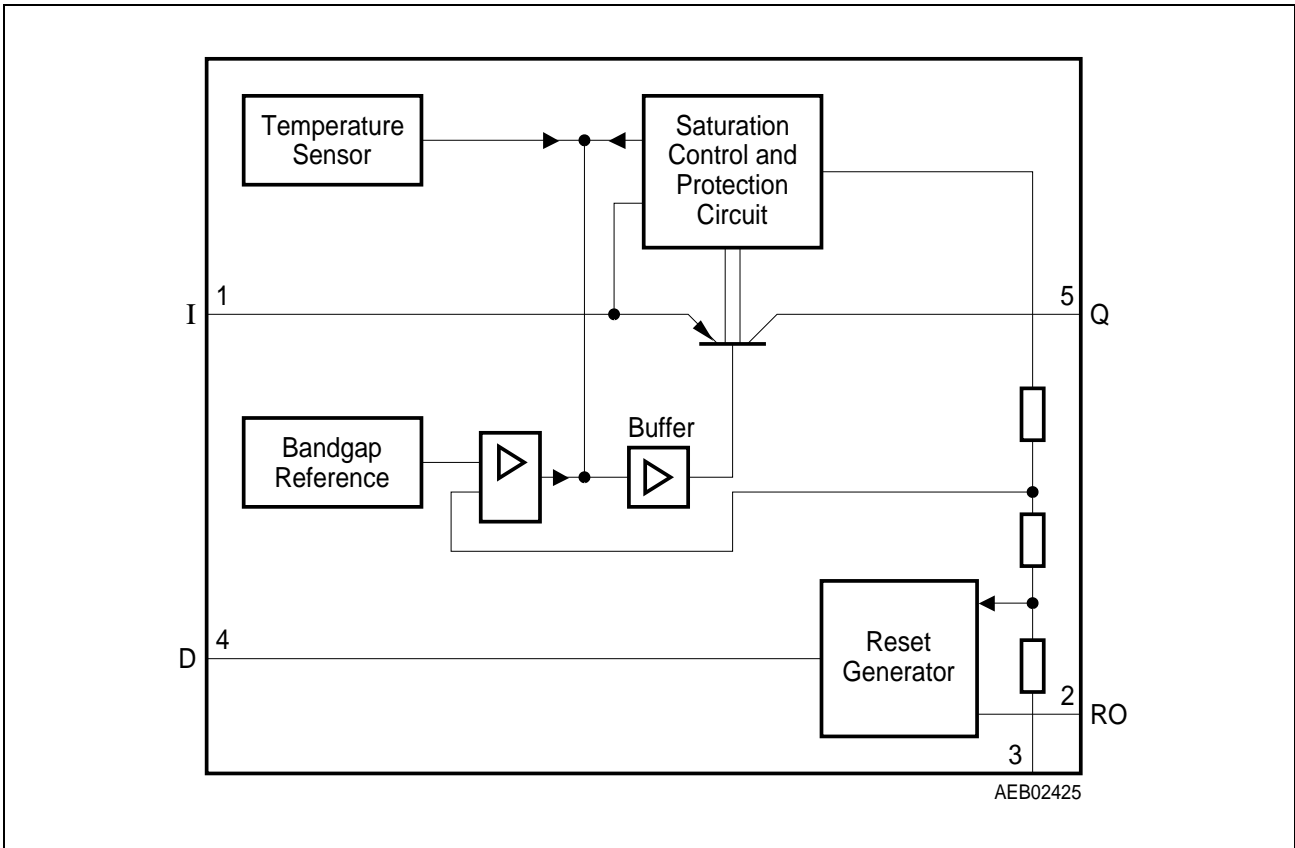

**Figure 2 Block Diagram**

**Table 2 Absolute Maximum Ratings**

Parameter	Symbol	Limit Values		Unit	Test Condition
		Min.	Max.		
<b>Input</b>					
Voltage	$V_I$	-42	45	V	–
Current	$I_I$	–	–	–	Internally limited
<b>Output</b>					
Voltage	$V_Q$	-1.0	16	V	–
Current	$I_Q$	–	–	–	Internally limited
<b>Reset Output</b>					
Voltage	$V_{RO}$	-0.3	25	V	–
Current	$I_{RO}$	– 5	5	mA	–
<b>Reset Delay</b>					
Voltage	$V_D$	-0.3	7	V	–
Current	$I_D$	-2	2	mA	–
<b>Temperature</b>					
Junction temperature	$T_j$	-40	150	°C	–
Storage temperature	$T_{stg}$	-50	150	°C	–

*Note: Maximum ratings are absolute ratings; exceeding any one of these values may cause irreversible damage to the integrated circuit.*

**Table 3 Operating Range**

Parameter	Symbol	Limit Values		Unit	Remarks
		Min.	Max.		
Input voltage	$V_I$	5.5	42	V	–
Junction temperature	$T_j$	-40	150	°C	–
<b>Thermal Resistance</b>					
Junction case	$R_{thjc}$	–	4	K/W	–
Junction ambient	$R_{thj-a}$	–	53	K/W	TO263 <sup>1)</sup>
Junction ambient	$R_{thj-a}$	–	78	K/W	TO252 <sup>1)</sup>
Junction ambient	$R_{thj-a}$	–	65	K/W	TO220

1) Worst case, regarding peak temperature; zero airflow; mounted on a PCB FR4, 80 × 80 × 1.5 mm<sup>3</sup>, heat sink area 300 mm<sup>2</sup>

**Table 4 Characteristics**
 $V_I = 13.5 \text{ V}; -40 \text{ }^\circ\text{C} < T_j < 150 \text{ }^\circ\text{C}$  (unless otherwise specified)

Parameter	Symbol	Limit Values			Unit	Measuring Condition
		Min.	Typ.	Max.		
<b>Output</b>						
Output voltage	$V_Q$	4.9	5.0	5.1	V	$5 \text{ mA} < I_Q < 400 \text{ mA}$ $6 \text{ V} < V_I < 28 \text{ V}$
Output voltage	$V_Q$	4.9	5.0	5.1	V	$5 \text{ mA} < I_Q < 200 \text{ mA}$ $6 \text{ V} < V_I < 40 \text{ V}$
Output current limitation <sup>1)</sup>	$I_Q$	450	700	–	mA	–
Current consumption; $I_q = I_I - I_Q$	$I_q$	–	150	200	$\mu\text{A}$	$I_Q = 1 \text{ mA};$ $T_j = 25 \text{ }^\circ\text{C}$
Current consumption; $I_q = I_I - I_Q$	$I_q$	–	150	220	$\mu\text{A}$	$I_Q = 1 \text{ mA};$ $T_j \leq 85 \text{ }^\circ\text{C}$
Current consumption; $I_q = I_I - I_Q$	$I_q$	–	5	10	mA	$I_Q = 250 \text{ mA}$
Current consumption; $I_q = I_I - I_Q$	$I_q$	–	12	22	mA	$I_Q = 400 \text{ mA}$
Drop voltage <sup>1)</sup>	$V_{\text{dr}}$	–	250	500	mV	$I_Q = 300 \text{ mA};$ $V_{\text{dr}} = V_I - V_Q$
Load regulation	$\Delta V_Q$	–	15	30	mV	$I_Q = 5 \text{ mA to } 400 \text{ mA}$
Line regulation	$\Delta V_Q$	-15	5	15	mV	$\Delta V_I = 8 \text{ V to } 32 \text{ V}$ $I_Q = 5 \text{ mA}$
Power supply ripple rejection	$PSRR$	–	60	–	dB	$f_r = 100 \text{ Hz};$ $V_r = 0.5 \text{ Vpp}$
Temperature output voltage drift	$dV_Q/dT$	–	0.5	–	mV/K	–

**Table 4 Characteristics (cont'd)**
 $V_1 = 13.5 \text{ V}; -40 \text{ }^\circ\text{C} < T_j < 150 \text{ }^\circ\text{C}$  (unless otherwise specified)

Parameter	Symbol	Limit Values			Unit	Measuring Condition
		Min.	Typ.	Max.		
<b>Reset Timing D and Output RO</b>						
Reset switching threshold	$V_{Q,rt}$	4.5	4.65	4.8	V	–
Reset output low voltage	$V_{ROL}$	–	0.2	0.4	V	$R_{ext} \geq 5 \text{ k}\Omega;$ $V_Q > 1 \text{ V}$
Reset output leakage current	$I_{ROH}$	–	0	10	$\mu\text{A}$	$V_{ROH} = 5 \text{ V}$
Reset charging current	$I_{D,c}$	3.0	5.5	9.0	$\mu\text{A}$	$V_D = 1 \text{ V}$
Upper timing threshold	$V_{DU}$	1.5	1.8	2.2	V	–
Lower timing threshold	$V_{DRL}$	0.2	0.4	0.7	V	–
Reset delay time	$t_{rd}$	10	16	22	ms	$C_D = 47 \text{ nF}$
Reset reaction time	$t_{rr}$	–	0.5	2	$\mu\text{s}$	$C_D = 47 \text{ nF}$

 1) Measured when the output voltage  $V_Q$  has dropped 100 mV from the nominal value obtained at  $V_1 = 13.5 \text{ V}$ .

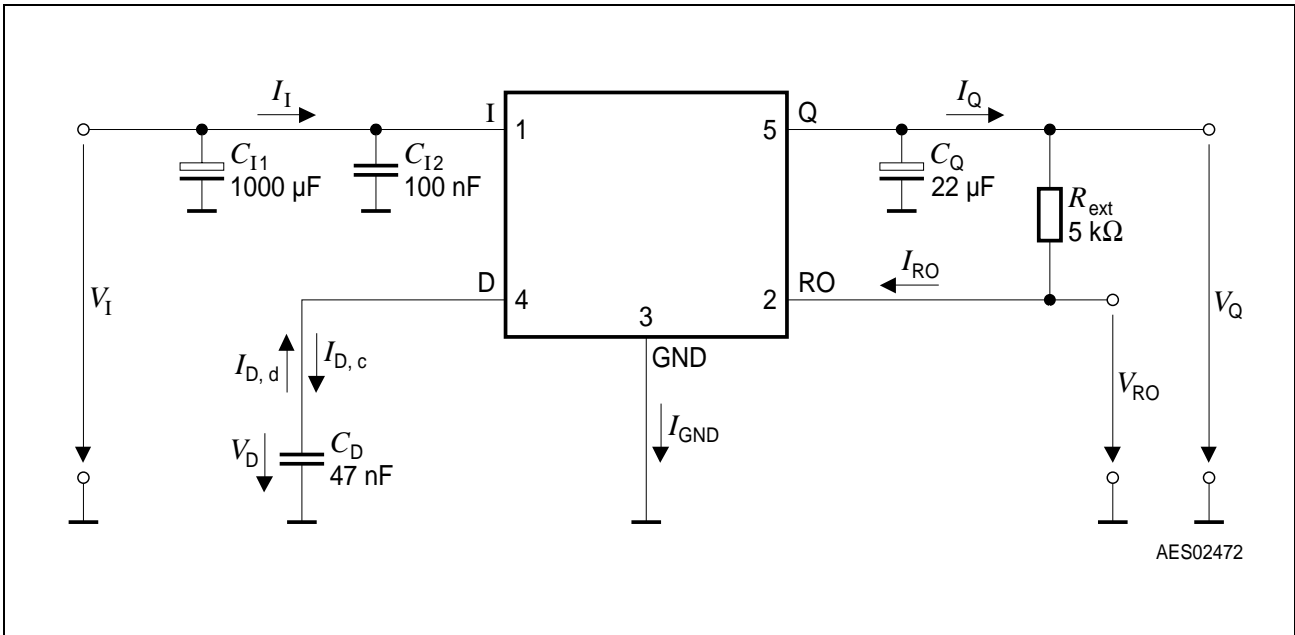

AES02472

**Figure 3 Test Circuit**

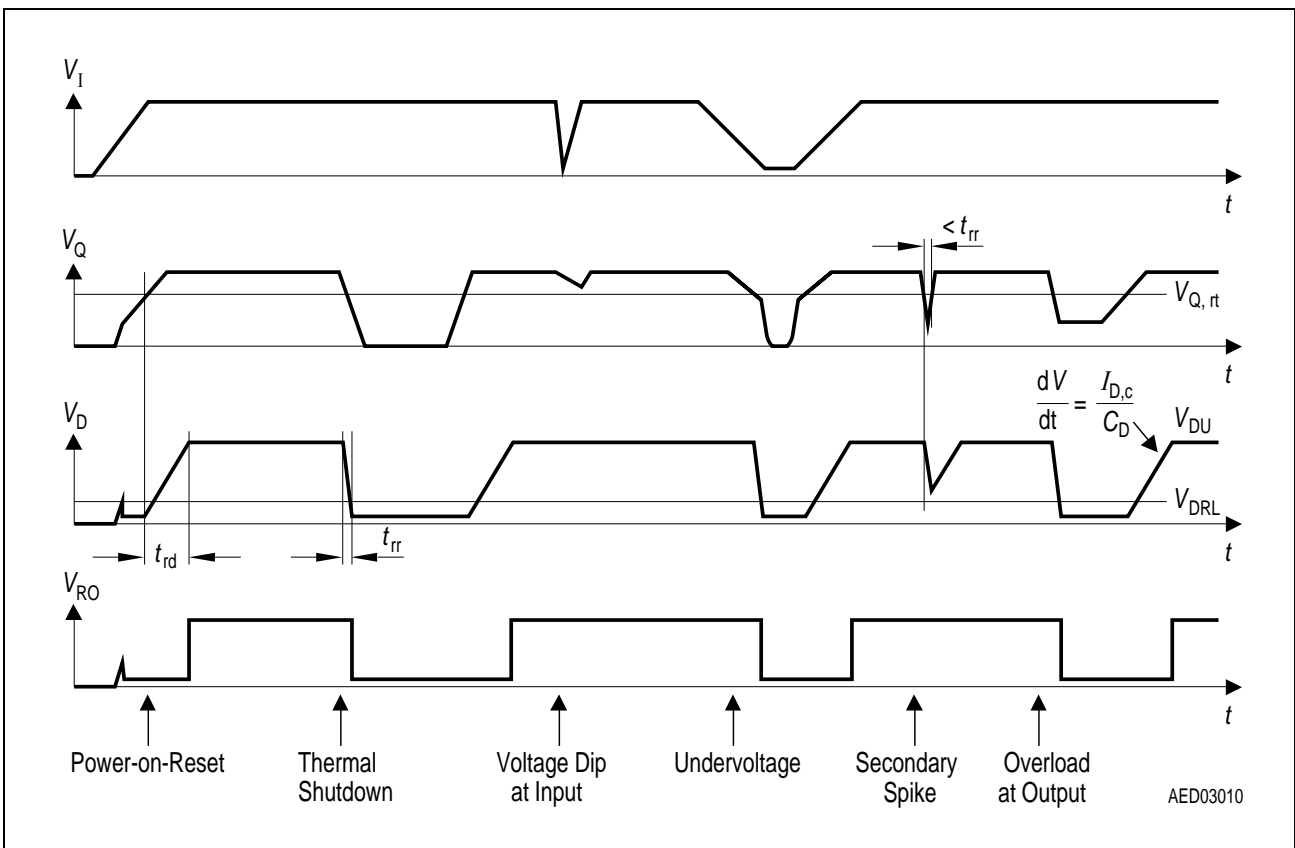

AED03010

**Figure 4 Reset Timing**



**Output Voltage  $V_Q$  versus Temperature  $T_j$**

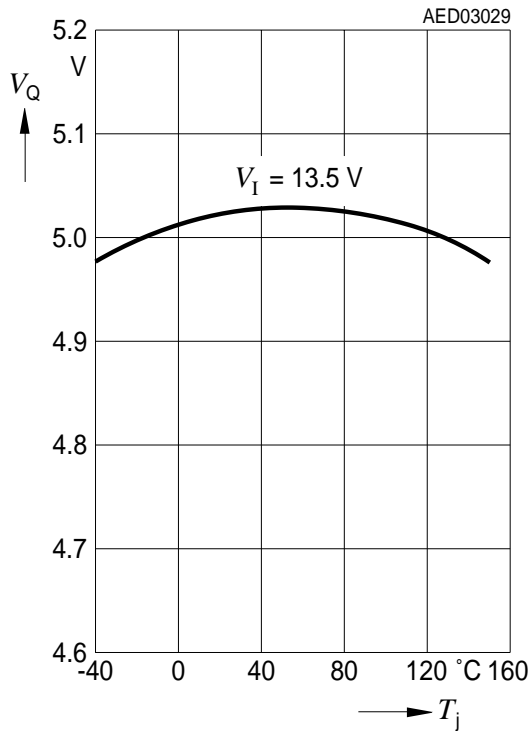

**Output Current  $I_Q$  versus Temperature  $T_j$**

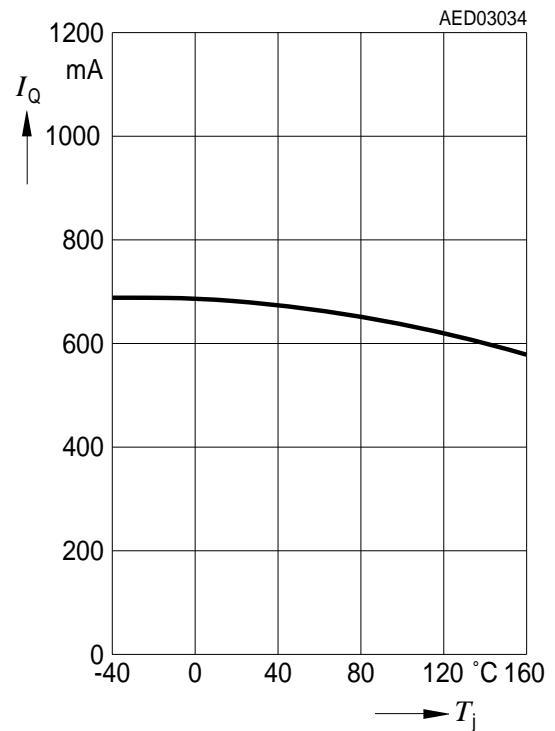

**Output Voltage  $V_Q$  versus Temperature  $T_j$**

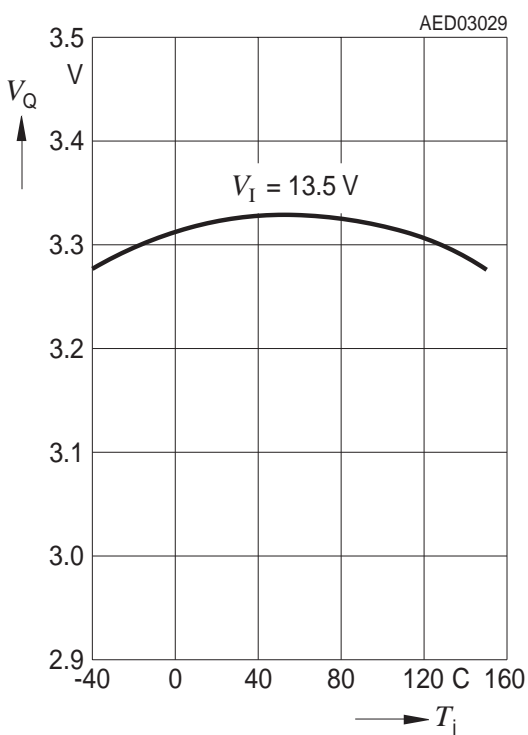

**Output Voltage  $V_Q$  versus Input Voltage  $V_I$**

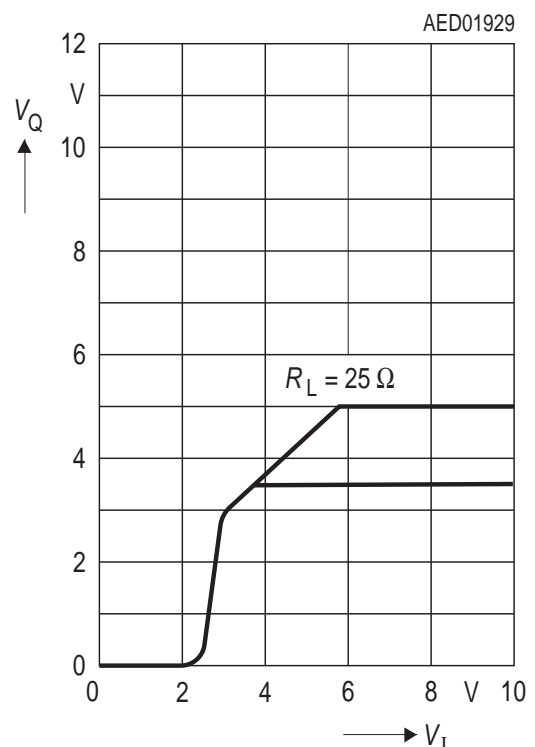

**Output Current  $I_Q$  versus Input Voltage  $V_I$**

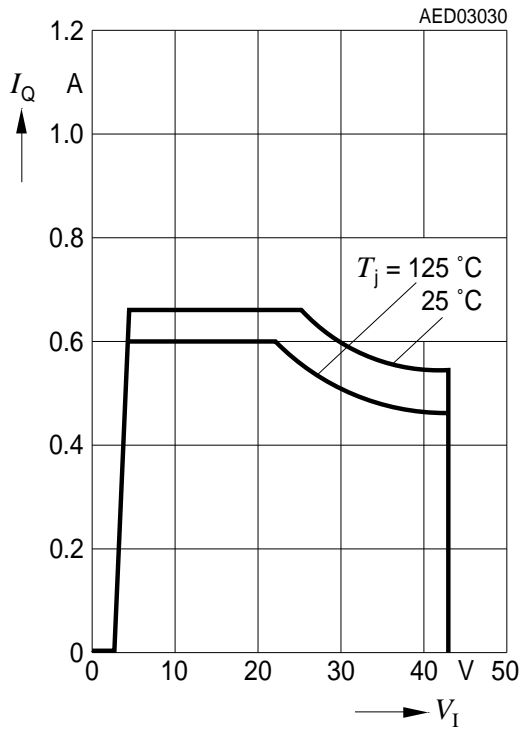

**Current Consumption  $I_q$  versus Output Current  $I_Q$**

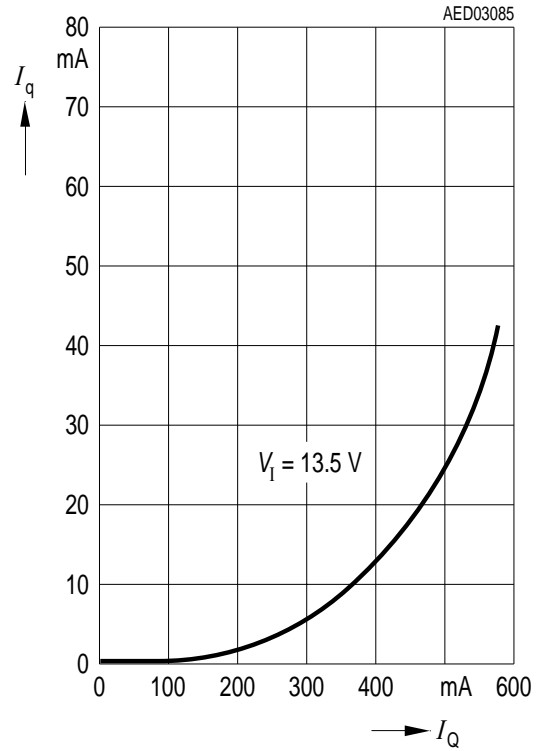

**Current Consumption  $I_q$  versus Output Current  $I_Q$**

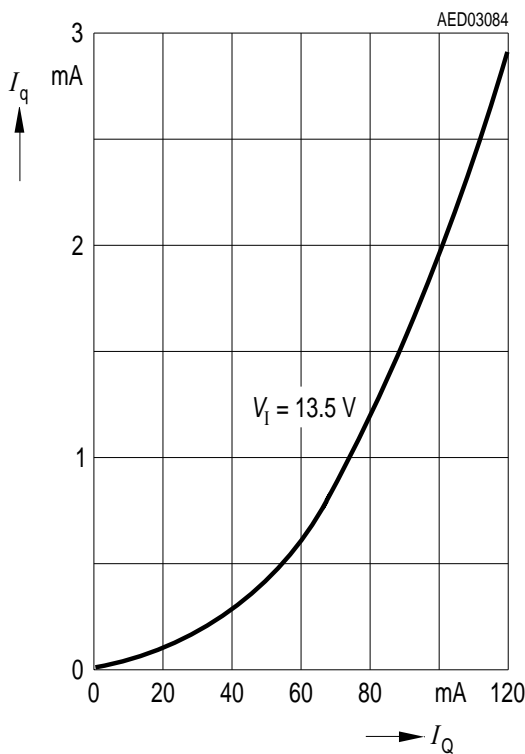

**Drop Voltage  $V_{dr}$  versus Output Current  $I_Q$**

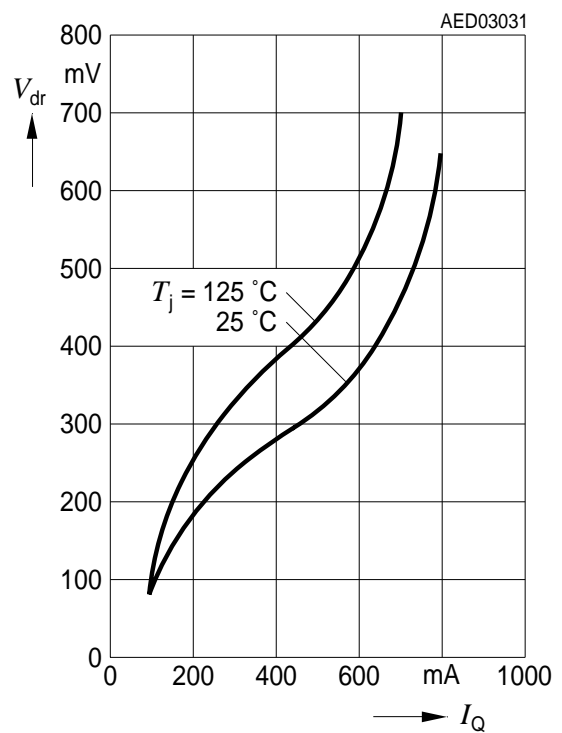

**Charge Current  $I_{D,c}$   
versus Temperature  $T_j$**

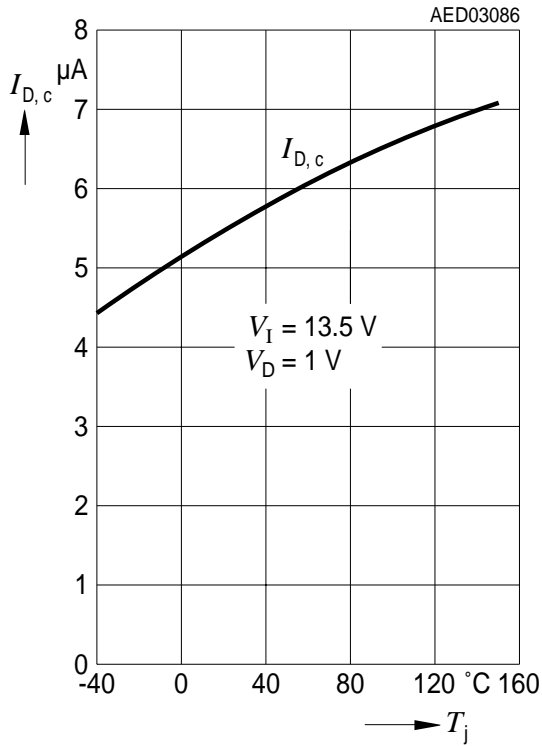

**Delay Switching Threshold  $V_{DU}$ ,  $V_{DRL}$   
versus Temperature  $T_j$**

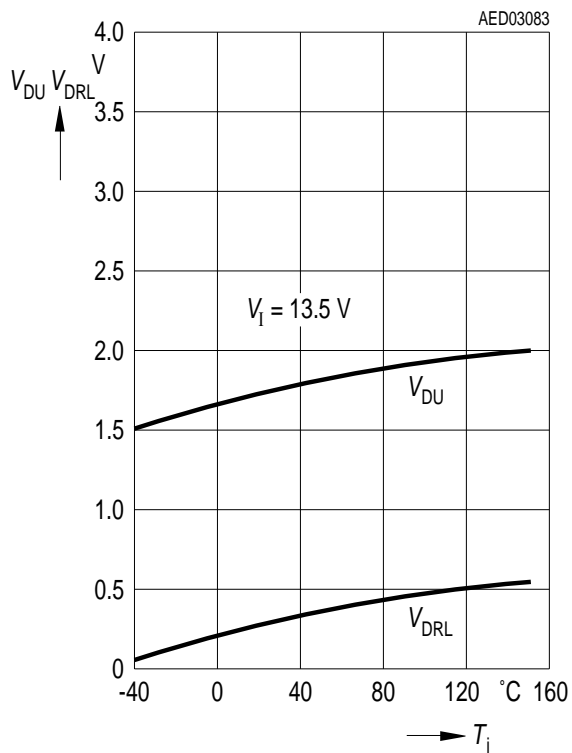

Package Outlines

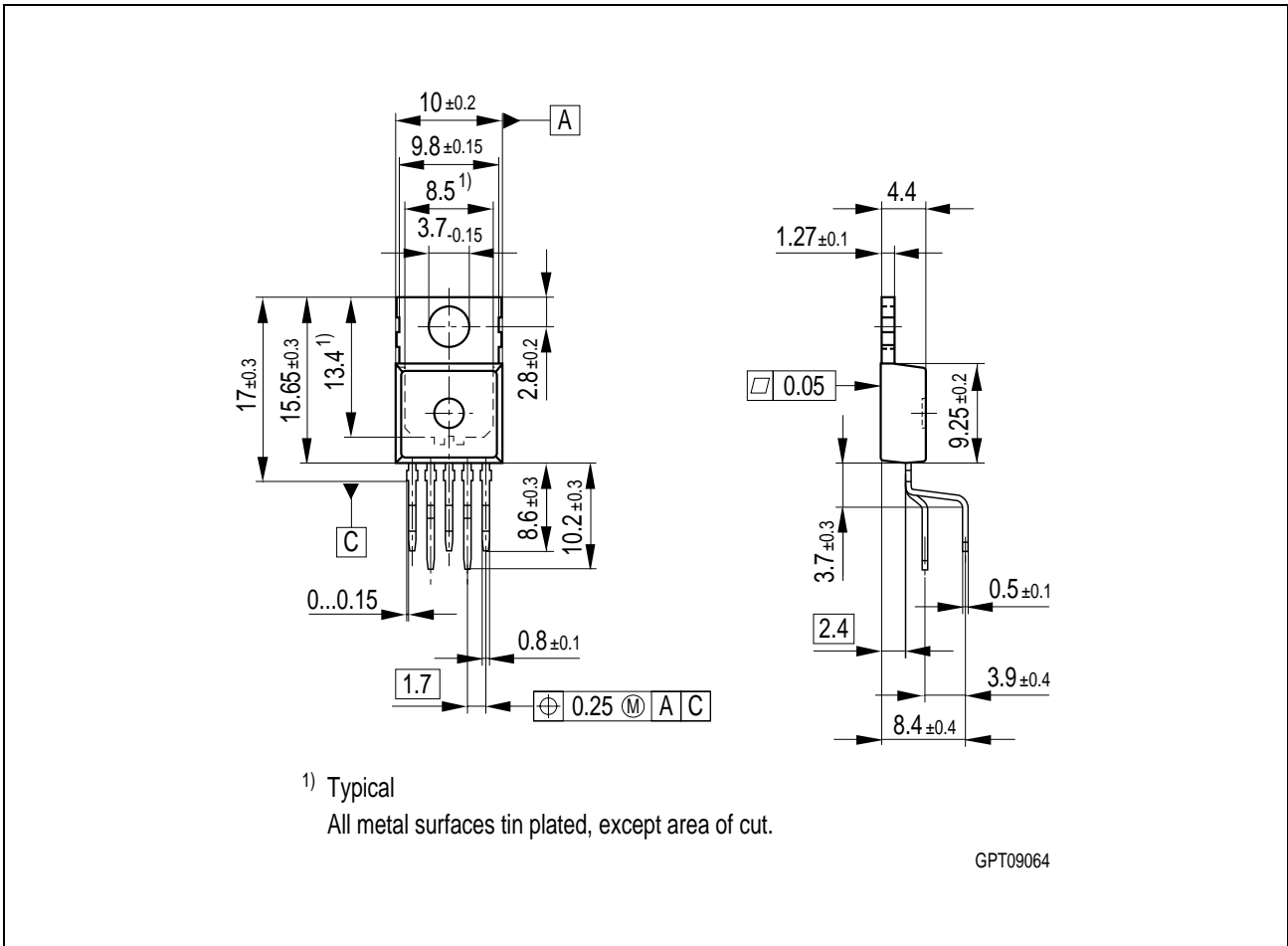

Figure 5 PG-TO220-5-11 (Plastic Transistor Single Outline)

Green Product (RoHS compliant)

To meet the world-wide customer requirements for environmentally friendly products and to be compliant with government regulations the device is available as a green product. Green products are RoHS-Compliant (i.e Pb-free finish on leads and suitable for Pb-free soldering according to IPC/JEDEC J-STD-020).

You can find all of our packages, sorts of packing and others in our Infineon Internet Page "Products": <http://www.infineon.com/products>.

SMD = Surface Mounted Device

Dimensions in mm

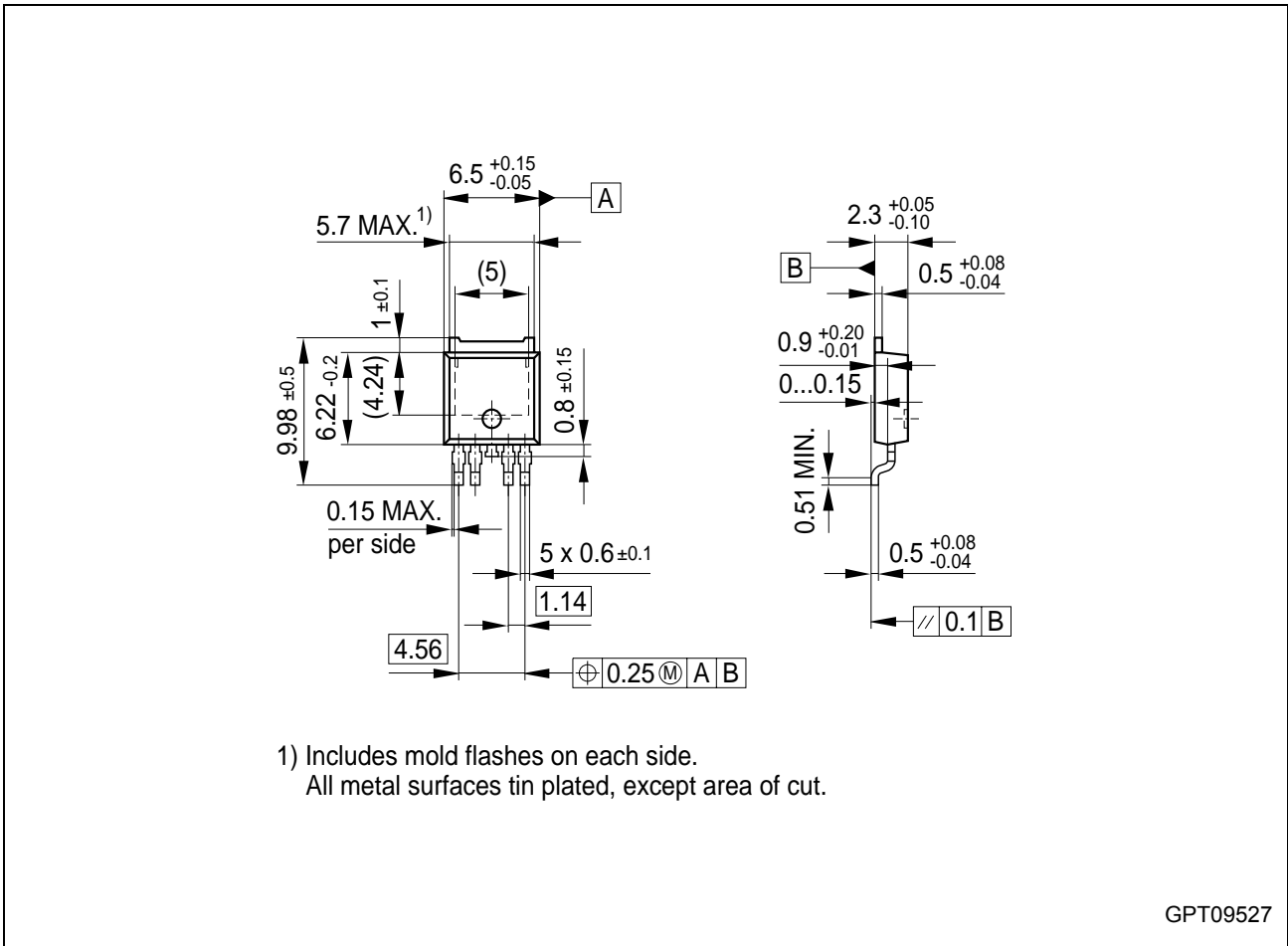

**Figure 6 PG-TO252-5-11 (Plastic Transistor Single Outline)**

**Green Product (RoHS compliant)**

To meet the world-wide customer requirements for environmentally friendly products and to be compliant with government regulations the device is available as a green product. Green products are RoHS-Compliant (i.e Pb-free finish on leads and suitable for Pb-free soldering according to IPC/JEDEC J-STD-020).

You can find all of our packages, sorts of packing and others in our Infineon Internet Page "Products": <http://www.infineon.com/products>.

SMD = Surface Mounted Device

Dimensions in mm

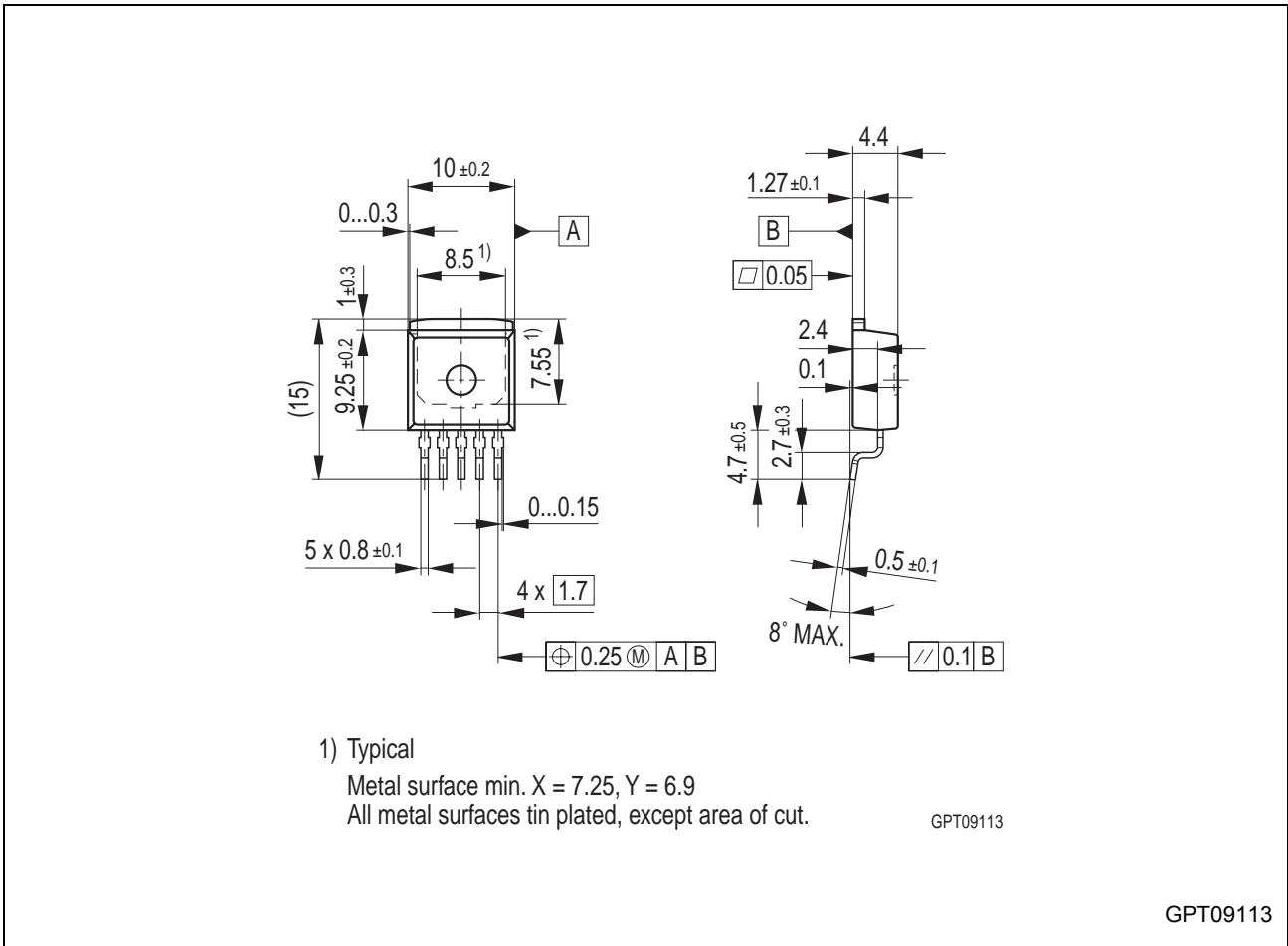

**Figure 7 PG-T0263-5-1 (Plastic Transistor Single Outline)**

**Green Product (RoHS compliant)**

To meet the world-wide customer requirements for environmentally friendly products and to be compliant with government regulations the device is available as a green product. Green products are RoHS-Compliant (i.e Pb-free finish on leads and suitable for Pb-free soldering according to IPC/JEDEC J-STD-020).

You can find all of our packages, sorts of packing and others in our Infineon Internet Page "Products": <http://www.infineon.com/products>.

SMD = Surface Mounted Device

Dimensions in mm

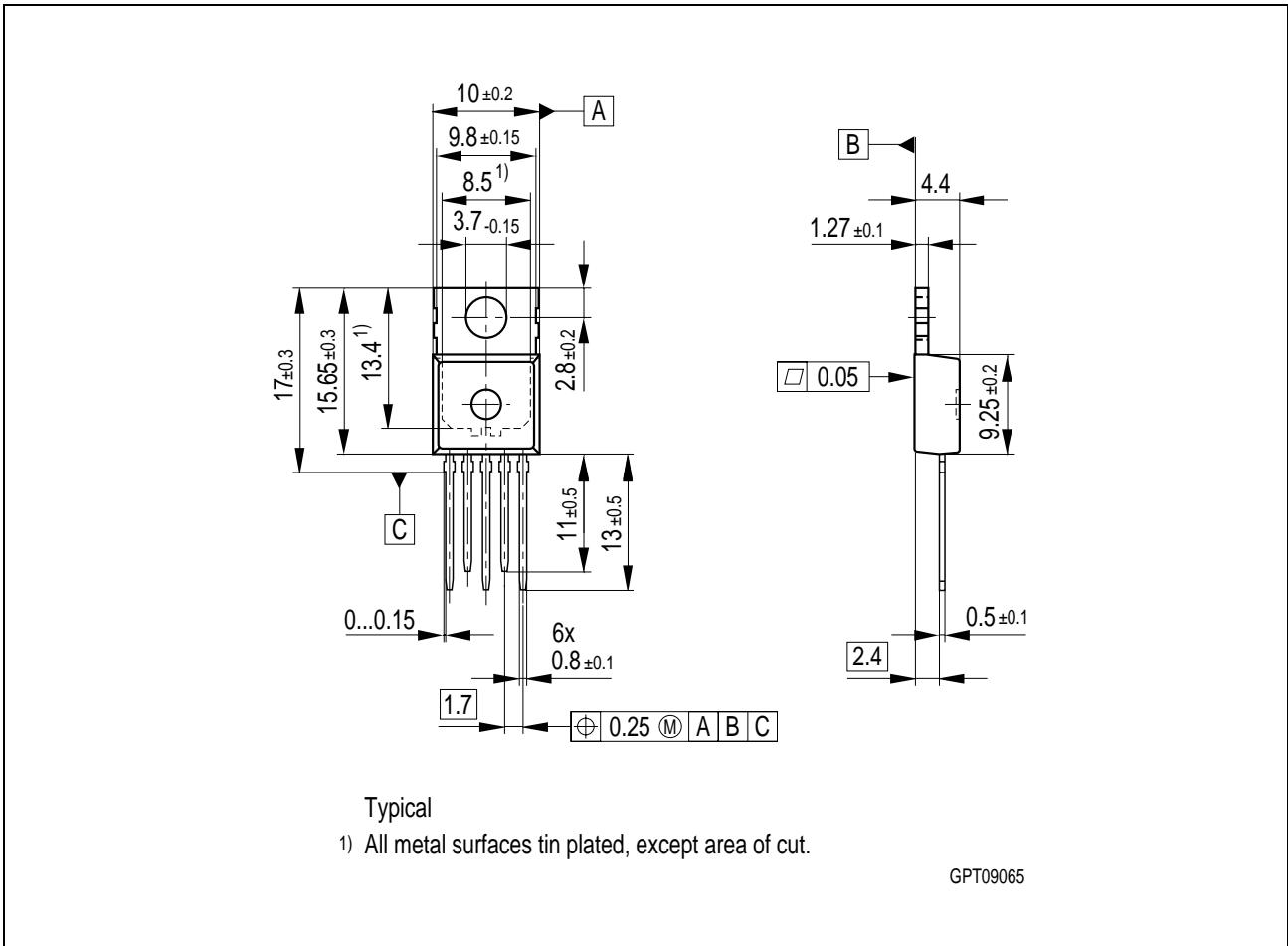

**Figure 8 PG-TO220-5-12 (Plastic Transistor Single Outline)**

**Green Product (RoHS compliant)**

To meet the world-wide customer requirements for environmentally friendly products and to be compliant with government regulations the device is available as a green product. Green products are RoHS-Compliant (i.e Pb-free finish on leads and suitable for Pb-free soldering according to IPC/JEDEC J-STD-020).

You can find all of our packages, sorts of packing and others in our Infineon Internet Page "Products": <http://www.infineon.com/products>.

SMD = Surface Mounted Device

Dimensions in mm

---

**TLE 4275****Revision History:**                      **2007-02-19**    Rev. 1.7

Previous Version:                      1.6

<b>Page</b>	<b>Subjects (major changes since last revision)</b>
general	Removed all information related to the TLE4275v33 Product Proposal. (See separate datasheet for the TLE4275v33)
general	Updated Infineon logo
#1	Added "AEC" and "Green" logo
#1	Added "Green Product" and "AEC qualified" to the feature list
#1	Updated Package Names to "PG-xxx"
general	Removed leadframe variant "P-TO-252-1"
#12 to #15	Added "Green Product" remark
#17	Disclaimer Update



**Edition 2007-02-19**

**Published by  
Infineon Technologies AG  
81726 München, Germany  
© Infineon Technologies AG 2007.  
All Rights Reserved.**

#### **Legal Disclaimer**

The information given in this document shall in no event be regarded as a guarantee of conditions or characteristics ("Beschaffenheitsgarantie"). With respect to any examples or hints given herein, any typical values stated herein and/or any information regarding the application of the device, Infineon Technologies hereby disclaims any and all warranties and liabilities of any kind, including without limitation warranties of non-infringement of intellectual property rights of any third party.

#### **Information**

For further information on technology, delivery terms and conditions and prices please contact your nearest Infineon Technologies Office ([www.infineon.com](http://www.infineon.com)).

#### **Warnings**

Due to technical requirements components may contain dangerous substances. For information on the types in question please contact your nearest Infineon Technologies Office.

Infineon Technologies Components may only be used in life-support devices or systems with the express written approval of Infineon Technologies, if a failure of such components can reasonably be expected to cause the failure of that life-support device or system, or to affect the safety or effectiveness of that device or system. Life support devices or systems are intended to be implanted in the human body, or to support and/or maintain and sustain and/or protect human life. If they fail, it is reasonable to assume that the health of the user or other persons may be endangered.