

TLE42754

Low Dropout Linear Fixed Voltage Regulator

TLE42754D
TLE42754G
TLE42754E

Data Sheet

Rev. 1.2, 2014-07-03

Automotive Power



1 Overview

Features

- Output Voltage 5 V ± 2%
- Output Current up to 450 mA
- Very low Current Consumption
- Power-on and Undervoltage Reset with Programmable Delay Time
- Reset Low Down to $V_{Q} = 1$ V
- Very Low Dropout Voltage
- Output Current Limitation
- Reverse Polarity Protection
- Overtemperature Protection
- Suitable for Use in Automotive Electronics
- Wide Temperature Range from -40 °C up to 150 °C
- Input Voltage Range from -42 V to 45 V
- Green Product (RoHS compliant)
- AEC Qualified

Description

The TLE42754 is a monolithic integrated low-dropout voltage regulator in a 5-pin TO-package, especially designed for automotive applications. An input voltage up to 42 V is regulated to an output voltage of 5.0 V. The component is able to drive loads up to 450 mA. It is short-circuit proof by the implemented current limitation and has an integrated overtemperature shutdown. A reset signal is generated for an output voltage $V_{Q,rt}$ of typically 4.65 V. The power-on reset delay time can be programmed by the external delay capacitor.

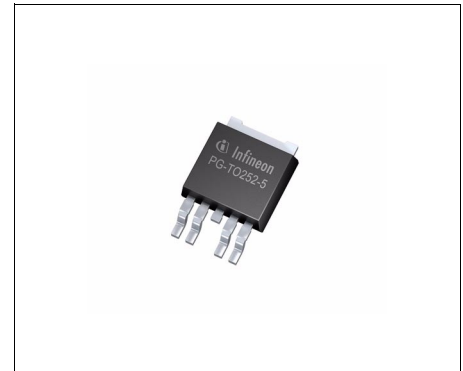

PG-TO252-5

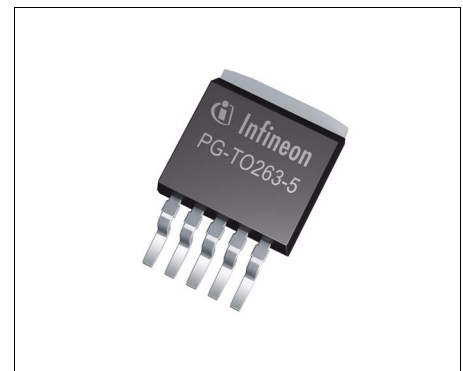

PG-TO263-5

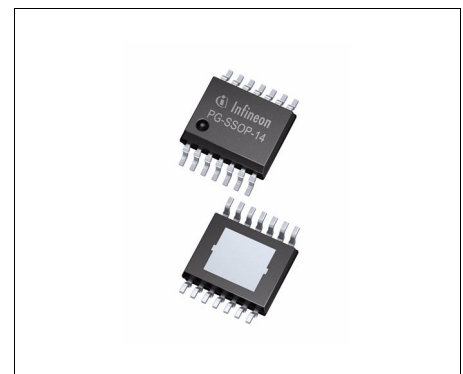

PG-SSOP-14 exposed pad

Type	Package	Marking
TLE42754D	PG-TO252-5	42754D
TLE42754G	PG-TO263-5	42754G
TLE42754E	PG-SSOP-14 exposed pad	42754E

Dimensioning Information on External Components

An input capacitor C_1 is recommended for compensation of line influences. An output capacitor C_Q is necessary for the stability of the control loop.

Circuit Description

The control amplifier compares a reference voltage to a voltage that is proportional to the output voltage and drives the base of the series transistor via a buffer. Saturation control as a function of the load current prevents any oversaturation of the power element. The component also has a number of internal circuits for protection against:

- Overload
- Overtemperature
- Reverse polarity

2 Block Diagram

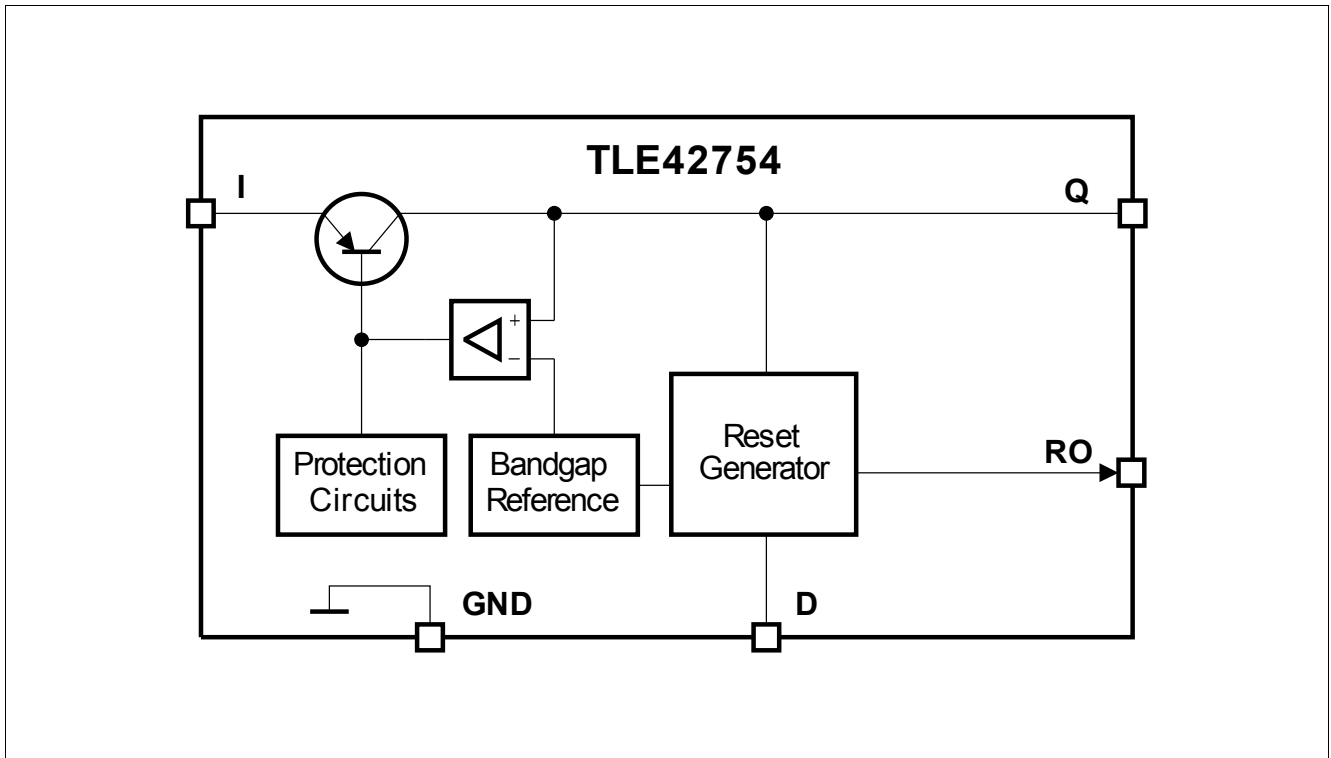

Figure 1 Block Diagram

3 Pin Configuration

3.1 Pin Assignment TLE42754D (PG-TO252-5) and TLE42754G (PG-TO263-5)

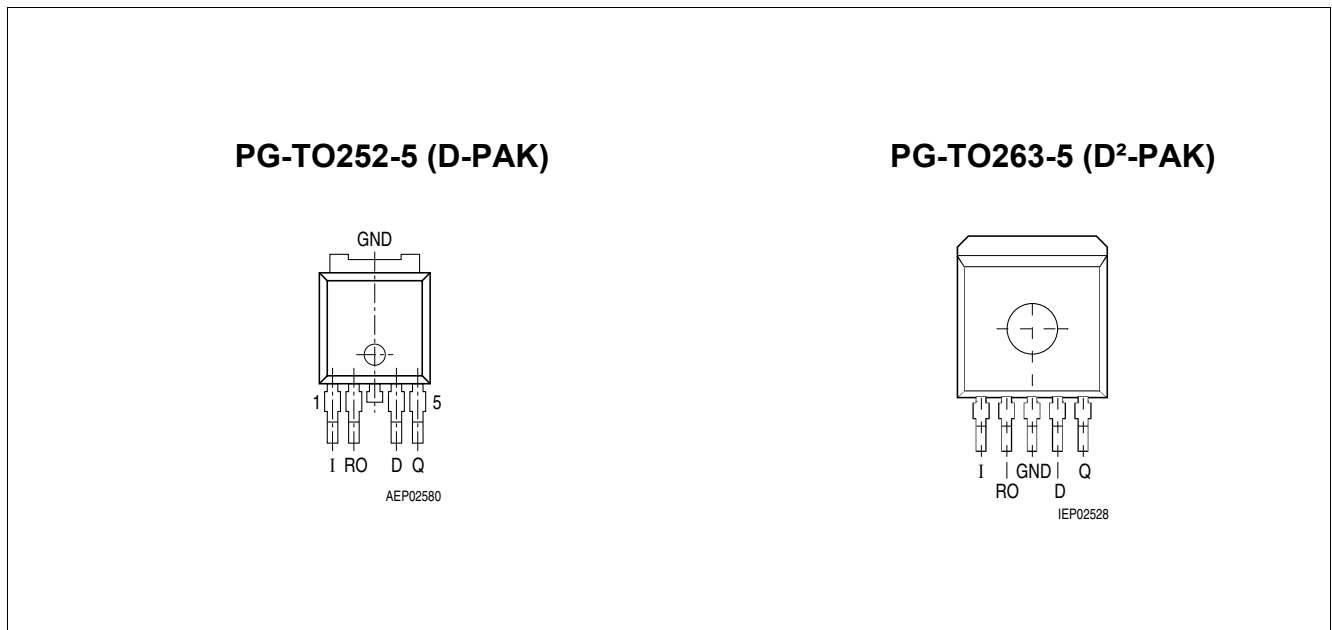

Figure 2 Pin Configuration (top view)

3.2 Pin Definitions and Functions TLE42754D (PG-TO252-5) and TLE42754G (PG-TO263-5)

Pin	Symbol	Function
1	I	Input for compensating line influences, a capacitor to GND close to the IC terminals is recommended
2	RO	Reset Output open collector output; external pull-up resistor to a positive potential required; leave open if the reset function is not needed
3	GND	TLE42754G (PG-TO263-5) only: Ground internally connected to tab
4	D	Reset Delay Timing connect a ceramic capacitor to GND for adjusting the reset delay time; leave open if the reset function is not needed
5	Q	Output block to GND with a capacitor close to the IC terminals, respecting the values given for its capacitance C_Q and ESR in the table “Functional Range” on Page 8
TAB	GND	Ground connect to heatsink area

3.3 Pin Assignment TLE42754E (PG-SSOP-14 exposed pad)

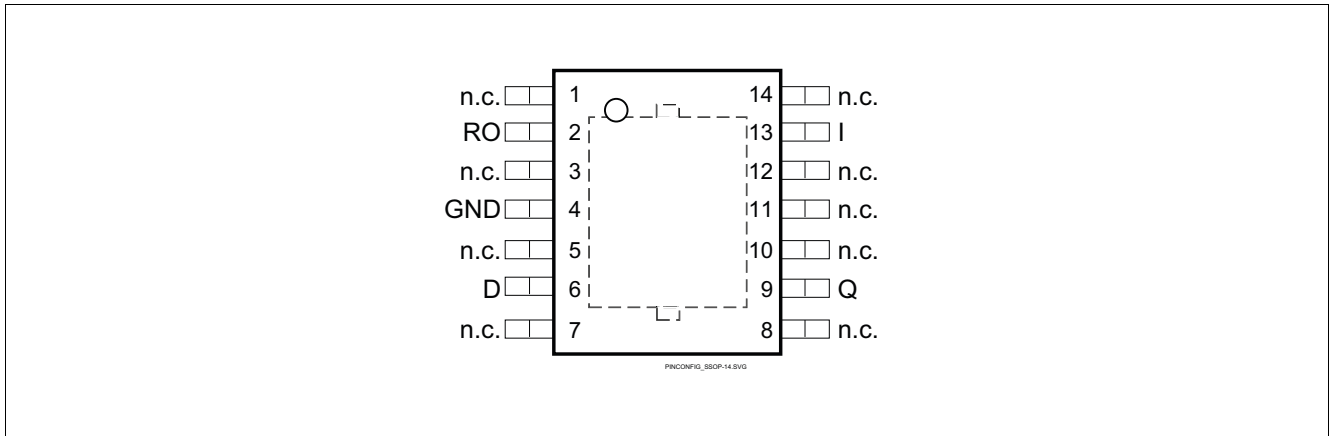

Figure 3 Pin Configuration (top view)

3.4 Pin Definitions and Functions TLE42754E (PG-SSOP-14 exposed pad)

Pin	Symbol	Function
1,3,5,7	n.c.	not connected leave open or connect to GND
2	RO	Reset Output open collector output; external pull-up resistor to a positive potential required; leave open if the reset function is not needed
4	GND	Ground
6	D	Reset Delay Timing connect a ceramic capacitor to GND for adjusting the reset delay time; leave open if the reset function is not needed
8,10,11,12, 14	n.c.	not connected leave open or connect to GND
9	Q	Output block to GND with a capacitor close to the IC terminals, respecting the values given for its capacitance C_Q and ESR in the table “Functional Range” on Page 8
13	I	Input for compensating line influences, a capacitor to GND close to the IC terminals is recommended
Pad	–	Exposed Pad connect to heatsink area; connect with GND on PCB

4 General Product Characteristics

4.1 Absolute Maximum Ratings

Table 1 Absolute Maximum Ratings¹⁾

-40 °C ≤ T_j ≤ 150°C; all voltages with respect to ground, positive current flowing into pin (unless otherwise specified)

Parameter	Symbol	Values			Unit	Note / Test Condition	Number
		Min.	Typ.	Max.			
Input							
Voltage	V_I	-42	–	45	V	–	P_4.1.1
Output							
Voltage	V_Q	-0.3	–	7	V	–	P_4.1.2
Reset Output							
Voltage	V_{RO}	-0.3	–	25	V	–	P_4.1.3
Reset Delay							
Voltage	V_D	-0.3	–	7	V	–	P_4.1.4
Temperature							
Junction Temperature	T_j	-40	–	150	°C	–	P_4.1.5
Storage Temperature	T_{stg}	-50	–	150	°C	–	P_4.1.6
ESD Absorption							
ESD Absorption	$V_{ESD,HBM}$	-2	–	2	kV	Human Body Model (HBM) ²⁾	P_4.1.7
ESD Absorption	$V_{ESD,CDM}$	-500	–	500	V	Charge Device Model (CDM) ³⁾	P_4.1.8
ESD Absorption	$V_{ESD,CDM}$	-750	–	750	V	Charge Device Model (CDM) ³⁾ at corner pins	P_4.1.9

1) Not subject to production test, specified by design.

2) ESD HBM Test according AEC-Q100-002 - JESD22-A114

3) ESD CDM Test according ESDA STM5.3.1

Notes

1. Stresses above the ones listed here may cause permanent damage to the device. Exposure to absolute maximum rating conditions for extended periods may affect device reliability.
2. Integrated protection functions are designed to prevent IC destruction under fault conditions described in the data sheet. Fault conditions are considered as "outside" normal operating range. Protection functions are not designed for continuous repetitive operation.

4.2 Functional Range

Table 2 Functional Range

Parameter	Symbol	Values			Unit	Note / Test Condition	Number
		Min.	Typ.	Max.			
Input Voltage	V_I	5.5	–	42	V	–	P_4.2.1
Output Capacitor's Requirements for Stability	C_Q	22	–	–	μF	– ¹⁾	P_4.2.2
Output Capacitor's Requirements for Stability	$ESR(C_Q)$	–	–	3	Ω	– ²⁾	P_4.2.3
Junction Temperature	T_j	-40	–	150	$^{\circ}\text{C}$	–	P_4.2.4

- 1) the minimum output capacitance requirement is applicable for a worst case capacitance tolerance of 30%
 2) relevant ESR value at $f = 10$ kHz

Note: Within the functional range the IC operates as described in the circuit description. The electrical characteristics are specified within the conditions given in the related electrical characteristics table.

4.3 Thermal Resistance

Table 3 Thermal Resistance

Parameter	Symbol	Values			Unit	Note / Test Condition	Number
		Min.	Typ.	Max.			
TLE42754D (PG-TO252-5)							
Junction to Case ¹⁾	R_{thJC}	–	3.7	–	K/W	–	P_4.3.1
Junction to Ambient ¹⁾	R_{thJA}	–	27	–	K/W	FR4 2s2p board ²⁾	P_4.3.2
Junction to Ambient ¹⁾	R_{thJA}	–	110	–	K/W	FR4 1s0p board, footprint only ³⁾	P_4.3.3
Junction to Ambient ¹⁾	R_{thJA}	–	57	–	K/W	FR4 1s0p board, 300 mm ² heatsink area on PCB ³⁾	P_4.3.4
Junction to Ambient ¹⁾	R_{thJA}	–	42	–	K/W	FR4 1s0p board, 600 mm ² heatsink area on PCB ³⁾	P_4.3.5
TLE42754G (PG-TO263-5)							
Junction to Case ¹⁾	R_{thJC}	–	3.7	–	K/W	–	P_4.3.6
Junction to Ambient ¹⁾	R_{thJA}	–	22	–	K/W	FR4 2s2p board ²⁾	P_4.3.7
Junction to Ambient ¹⁾	R_{thJA}	–	70	–	K/W	FR4 1s0p board, footprint only ³⁾	P_4.3.8
Junction to Ambient ¹⁾	R_{thJA}	–	42	–	K/W	FR4 1s0p board, 300 mm ² heatsink area on PCB ³⁾	P_4.3.9
Junction to Ambient ¹⁾	R_{thJA}	–	33	–	K/W	FR4 1s0p board, 600 mm ² heatsink area on PCB ³⁾	P_4.3.10
TLE42754E (PG-SSOP-14 exposed pad)							
Junction to Case ¹⁾	R_{thJC}	–	7	–	K/W	–	P_4.3.11
Junction to Ambient ¹⁾	R_{thJA}	–	43	–	K/W	FR4 2s2p board ²⁾	P_4.3.12
Junction to Ambient ¹⁾	R_{thJA}	–	120	–	K/W	FR4 1s0p board, footprint only ³⁾	P_4.3.13
Junction to Ambient ¹⁾	R_{thJA}	–	59	–	K/W	FR4 1s0p board, 300 mm ² heatsink area on PCB ³⁾	P_4.3.14
Junction to Ambient ¹⁾	R_{thJA}	–	49	–	K/W	FR4 1s0p board, 600 mm ² heatsink area on PCB ³⁾	P_4.3.15

1) not subject to production test, specified by design

2) Specified R_{thJA} value is according to Jedec JESD51-2,-5,-7 at natural convection on FR4 2s2p board; The Product (Chip+Package) was simulated on a 76.2 x 114.3 x 1.5 mm³ board with 2 inner copper layers (2 x 70µm Cu, 2 x 35µm Cu). Where applicable a thermal via array under the exposed pad contacted the first inner copper layer.

3) Specified R_{thJA} value is according to JEDEC JESD 51-3 at natural convection on FR4 1s0p board; The Product (Chip+Package) was simulated on a 76.2 x 114.3 x 1.5 mm³ board with 1 copper layer (1 x 70µm Cu).

5 Block Description and Electrical Characteristics

5.1 Voltage Regulator

The output voltage V_Q is controlled by comparing a portion of it to an internal reference and driving a PNP pass transistor accordingly. The control loop stability depends on the output capacitor C_Q , the load current, the chip temperature and the poles/zeros introduced by the integrated circuit. To ensure stable operation, the output capacitor's capacitance and its equivalent series resistor ESR requirements given in the table **“Functional Range” on Page 8** have to be maintained. For details see also the typical performance graph **“Output Capacitor Series Resistor ESR(C_Q) versus Output Current I_Q ” on Page 13**. As the output capacitor also has to buffer load steps it should be sized according to the application's needs.

An input capacitor C_I is strongly recommended to compensate line influences. Connect the capacitors close to the component's terminals.

A protection circuitry prevent the IC as well as the application from destruction in case of catastrophic events. These safeguards contain an output current limitation, a reverse polarity protection as well as a thermal shutdown in case of overtemperature.

In order to avoid excessive power dissipation that could never be handled by the pass element and the package, the maximum output current is decreased at input voltages above $V_I = 28\text{ V}$.

The thermal shutdown circuit prevents the IC from immediate destruction under fault conditions (e.g. output continuously short-circuited) by switching off the power stage. After the chip has cooled down, the regulator restarts. This leads to an oscillatory behaviour of the output voltage until the fault is removed. However, junction temperatures above $150\text{ }^\circ\text{C}$ are outside the maximum ratings and therefore significantly reduce the IC's lifetime.

The TLE42754 allows a negative supply voltage. In this fault condition, small currents are flowing into the IC, increasing its junction temperature. This has to be considered for the thermal design, respecting that the thermal protection circuit is not operating during reverse polarity conditions.

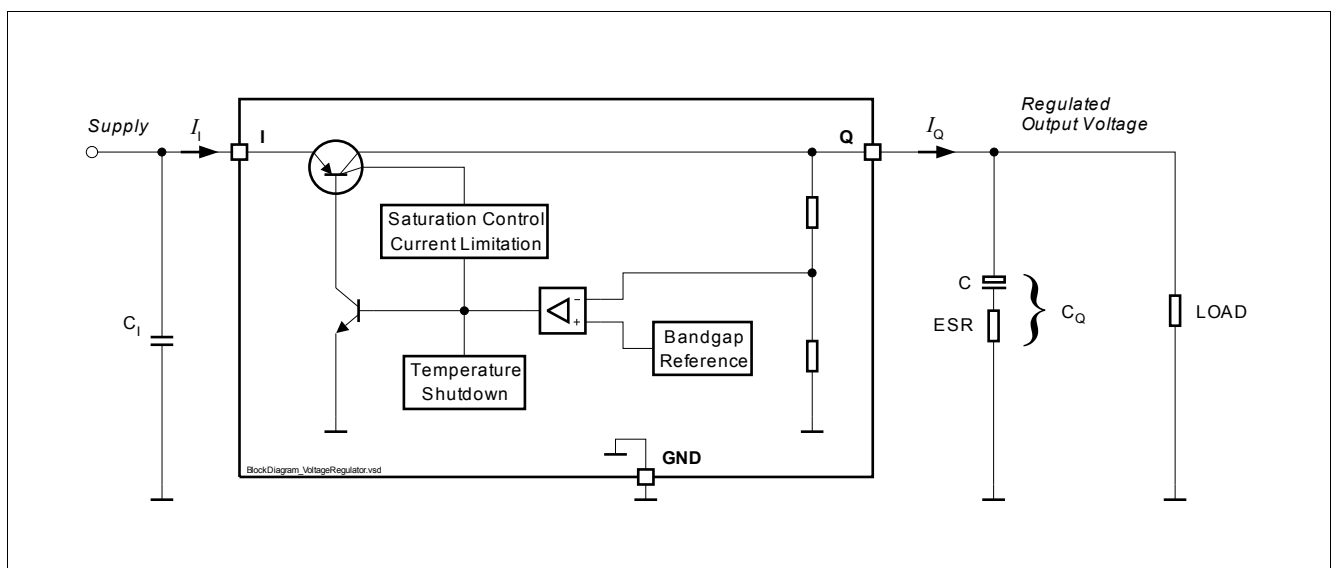

Figure 4 Voltage Regulator

Block Description and Electrical Characteristics

Table 4 Electrical Characteristics Voltage Regulator
 $V_I = 13.5\text{ V}$, $-40\text{ °C} \leq T_j \leq 150\text{ °C}$, all voltages with respect to ground, positive current flowing into pin (unless otherwise specified)

Parameter	Symbol	Values			Unit	Note / Test Condition	Number
		Min.	Typ.	Max.			
Output Voltage	V_Q	4.9	5.0	5.1	V	$1\text{ mA} < I_Q < 450\text{ mA}$ $9\text{ V} < V_I < 28\text{ V}$	P_5.1.1
Output Voltage	V_Q	4.9	5.0	5.1	V	$1\text{ mA} < I_Q < 400\text{ mA}$ $6\text{ V} < V_I < 28\text{ V}$	P_5.1.2
Output Voltage	V_Q	4.9	5.0	5.1	V	$1\text{ mA} < I_Q < 200\text{ mA}$ $6\text{ V} < V_I < 40\text{ V}$	P_5.1.3
Output Current Limitation	$I_{Q,max}$	450	–	1100	mA	$V_Q = 4.8\text{ V}$	P_5.1.4
Load Regulation steady-state	$\Delta V_{Q,load}$	-30	-15	–	mV	$I_Q = 5\text{ mA to } 400\text{ mA}$ $V_I = 8\text{ V}$	P_5.1.5
Line Regulation steady-state	$\Delta V_{Q,line}$	–	5	15	mV	$V_I = 8\text{ V to } 32\text{ V}$ $I_Q = 5\text{ mA}$	P_5.1.6
Dropout Voltage ¹⁾ $V_{dr} = V_I - V_Q$	V_{dr}	–	250	500	mV	$I_Q = 300\text{ mA}$	P_5.1.7
Power Supply Ripple Rejection ²⁾	$PSRR$	–	60	–	dB	$f_{ripple} = 100\text{ Hz}$ $V_{ripple} = 0.5\text{ Vpp}$	P_5.1.8
Temperature Output Voltage Drift	dV_Q/dT	–	0.5	–	mV/K	–	P_5.1.9
Overtemperature Shutdown Threshold	$T_{j,sd}$	151	–	200	°C	T_j increasing ²⁾	P_5.1.10
Overtemperature Shutdown Threshold Hysteresis	$T_{j,sdh}$	–	20	–	°C	T_j decreasing ²⁾	P_5.1.11

1) measured when the output voltage V_Q has dropped 100mV from the nominal value obtained at $V_I = 13.5\text{ V}$

2) not subject to production test, specified by design

Typical Performance Characteristics Voltage Regulator

Output Voltage V_Q versus Junction Temperature T_j

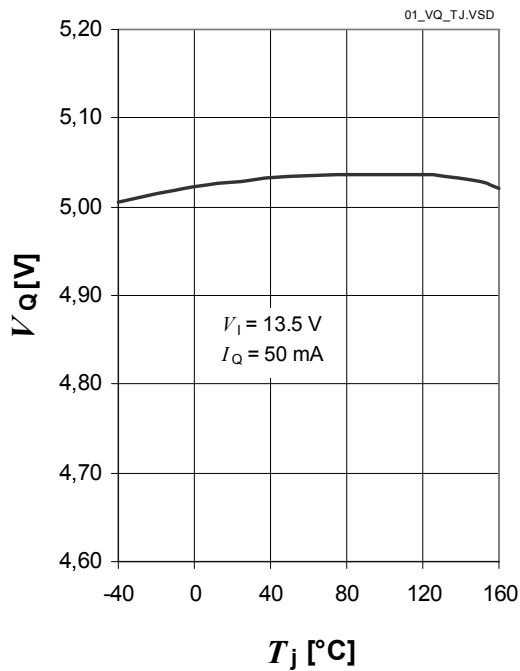

Output Current Limitation $I_{Q,max}$ versus Input Voltage V_I

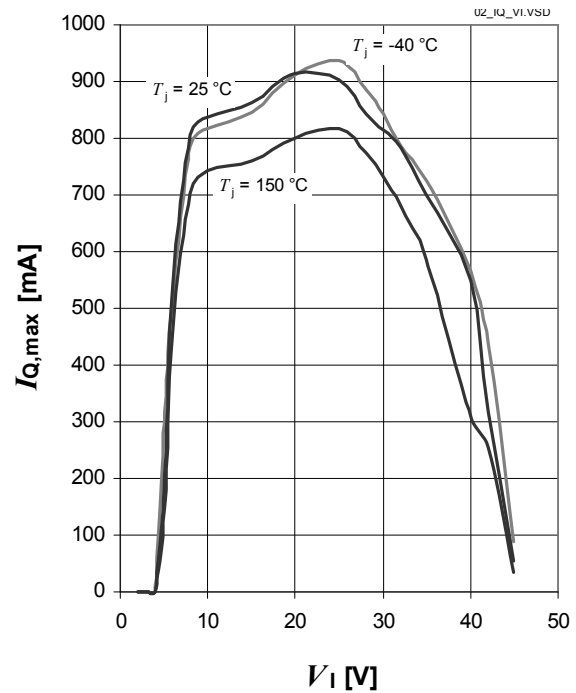

Power Supply Ripple Rejection $PSRR$ versus Ripple Frequency f_r

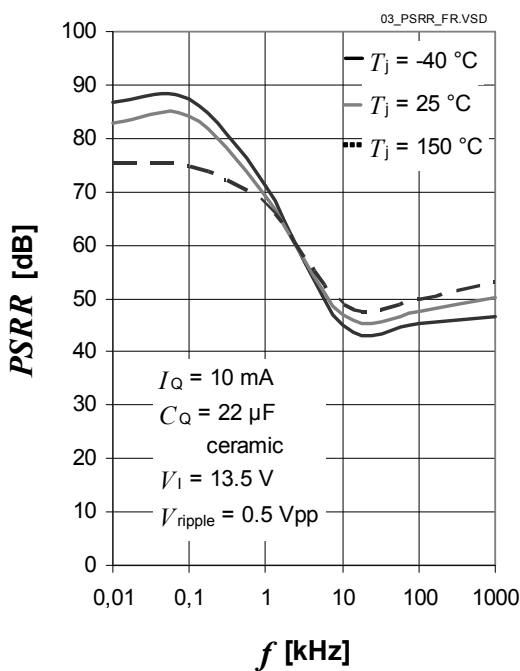

Line Regulation ΔV_Q versus Input Voltage Change ΔV_I

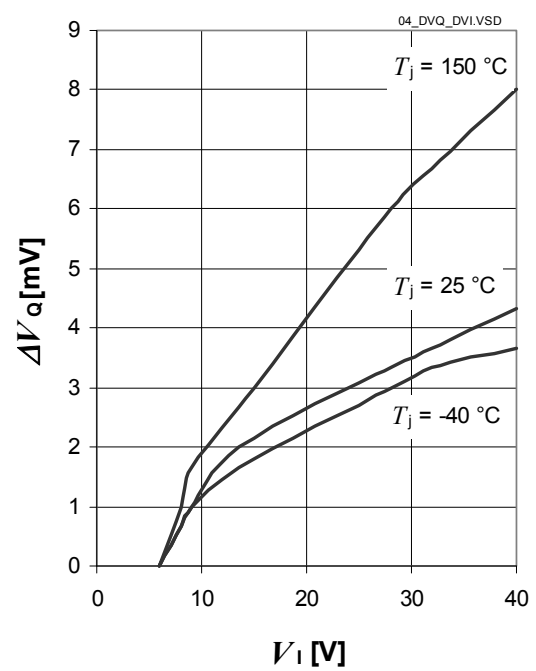

Block Description and Electrical Characteristics

Load Regulation $\Delta V_{Q,load}$ versus Output Current Change ΔI_Q

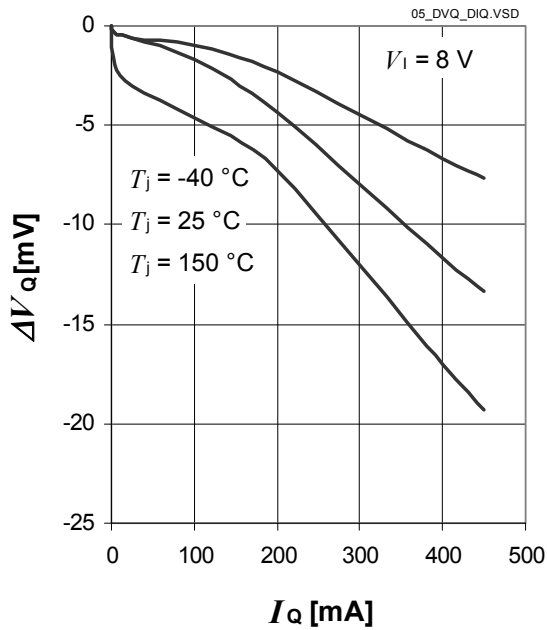

Output Capacitor Series Resistor $ESR(C_Q)$ versus Output Current I_Q

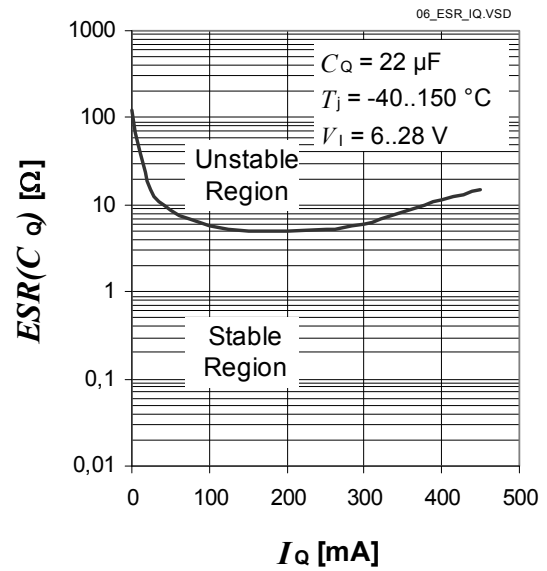

Dropout Voltage V_{dr} versus Junction Temperature T_j

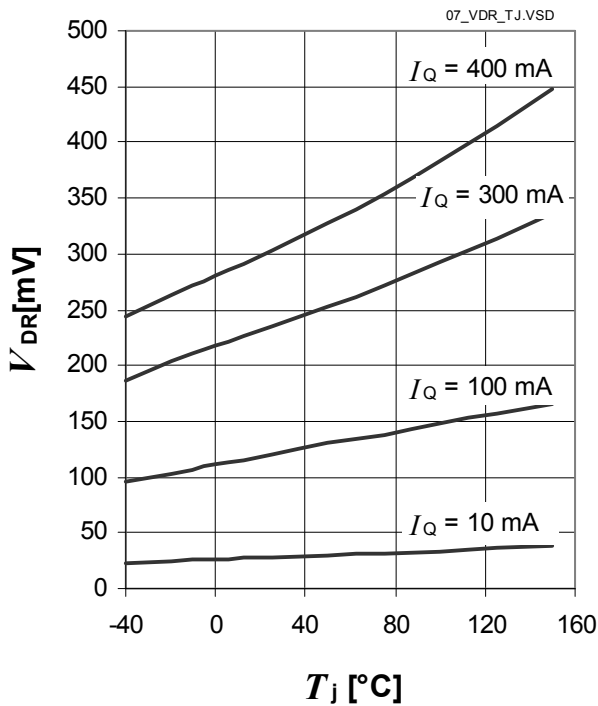

5.2 Current Consumption

Table 5 Electrical Characteristics Current Consumption

$V_1 = 13.5\text{ V}$, $-40\text{ °C} \leq T_j \leq 150\text{ °C}$, positive current flowing into pin (unless otherwise specified)

Parameter	Symbol	Values			Unit	Note / Test Condition	Number
		Min.	Typ.	Max.			
Current Consumption $I_q = I_1 - I_Q$	I_q	–	150	200	μA	$I_Q = 1\text{ mA}$, $T_j = 25\text{ °C}$	P_5.2.1
Current Consumption $I_q = I_1 - I_Q$	I_q	–	150	220	μA	$I_Q = 1\text{ mA}$, $T_j = 85\text{ °C}$	P_5.2.2
Current Consumption $I_q = I_1 - I_Q$	I_q	–	5	10	mA	$I_Q = 250\text{ mA}$	P_5.2.3
Current Consumption $I_q = I_1 - I_Q$	I_q	–	15	25	mA	$I_Q = 400\text{ mA}$	P_5.2.4

Typical Performance Characteristics Current Consumption

Current Consumption I_q versus Output Current I_Q (I_Q low)

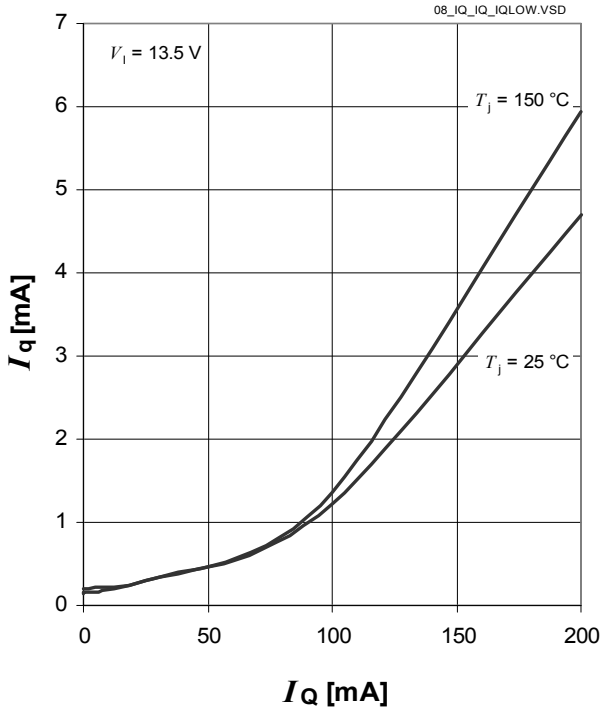

Current Consumption I_q versus Output Current I_Q

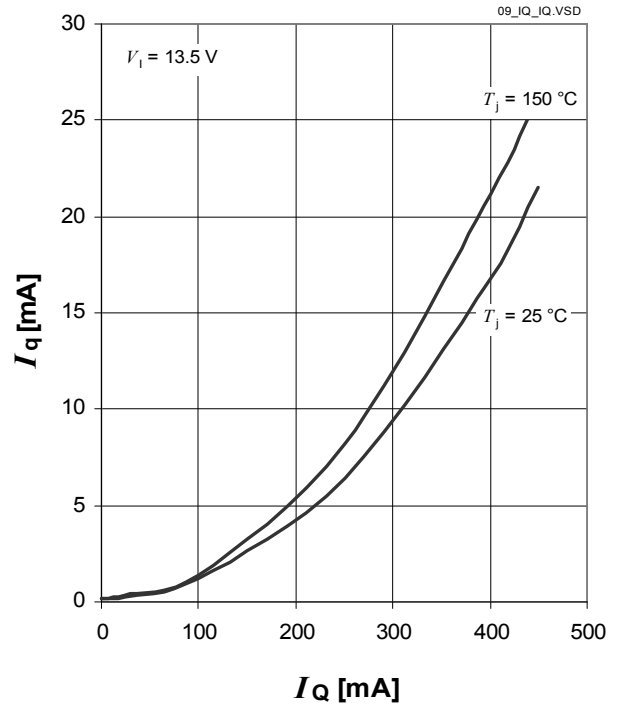

) Current Consumption I_q versus Input Voltage V_1

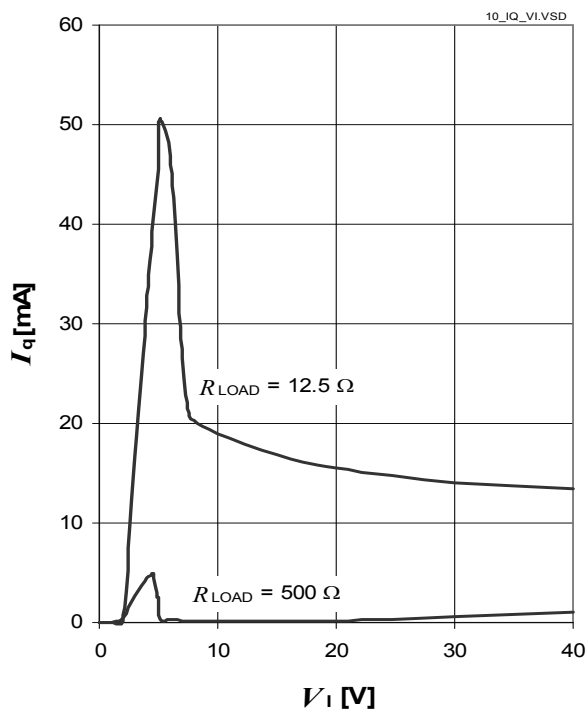

5.3 Reset Function

The reset function provides several features:

Output Undervoltage Reset:

An output undervoltage condition is indicated by setting the Reset Output RO to “low”. This signal might be used to reset a microcontroller during low supply voltage.

Power-On Reset Delay Time:

The power-on reset delay time t_{rd} allows a microcontroller and oscillator to start up. This delay time is the time frame from exceeding the reset switching threshold V_{RT} until the reset is released by switching the reset output “RO” from “low” to “high”. The power-on reset delay time t_{rd} is defined by an external delay capacitor C_D connected to pin D charged by the delay capacitor charge current $I_{D, ch}$ starting from $V_D = 0$ V.

If the application needs a power-on reset delay time t_{rd} different from the value given in **Power On Reset Delay Time**, the delay capacitor’s value can be derived from the specified values in **Power On Reset Delay Time** and the desired power-on delay time:

$$C_D = \frac{t_{rd, new}}{t_{rd}} \times 47nF \tag{1}$$

with

- C_D : capacitance of the delay capacitor to be chosen
- $t_{rd, new}$: desired power-on reset delay time
- t_{rd} : power-on reset delay time specified in this datasheet

For a precise calculation also take the delay capacitor’s tolerance into consideration.

Reset Reaction Time:

The reset reaction time avoids that short undervoltage spikes trigger an unwanted reset “low” signal. The reset reaction time t_{rr} considers the internal reaction time $t_{rr, int}$ and the discharge time $t_{rr, d}$ defined by the external delay capacitor C_D (see typical performance graph for details). Hence, the total reset reaction time becomes:

$$t_{rr} = t_{rd, int} + t_{rr, d} \tag{2}$$

with

- t_{rr} : reset reaction time
- $t_{rr, int}$: internal reset reaction time
- $t_{rr, d}$: reset discharge

Reset Output Pull-Up Resistor R_{RO} :

The Reset Output RO is an open collector output requiring an external pull-up resistor to a voltage V_{IO} , e.g. V_Q . In **Table 6 “Electrical Characteristics Reset Function” on Page 19** a minimum value for the external resistor R_{RO} is given for the case it is connected to V_Q or to a voltage $V_{IO} < V_Q$. If the pull-up resistor shall be connected to a voltage $V_{IO} > V_Q$, use the following formula:

$$R_{RO} = \frac{5k\Omega}{V_Q} \times V_{IO} \tag{3}$$

Block Description and Electrical Characteristics

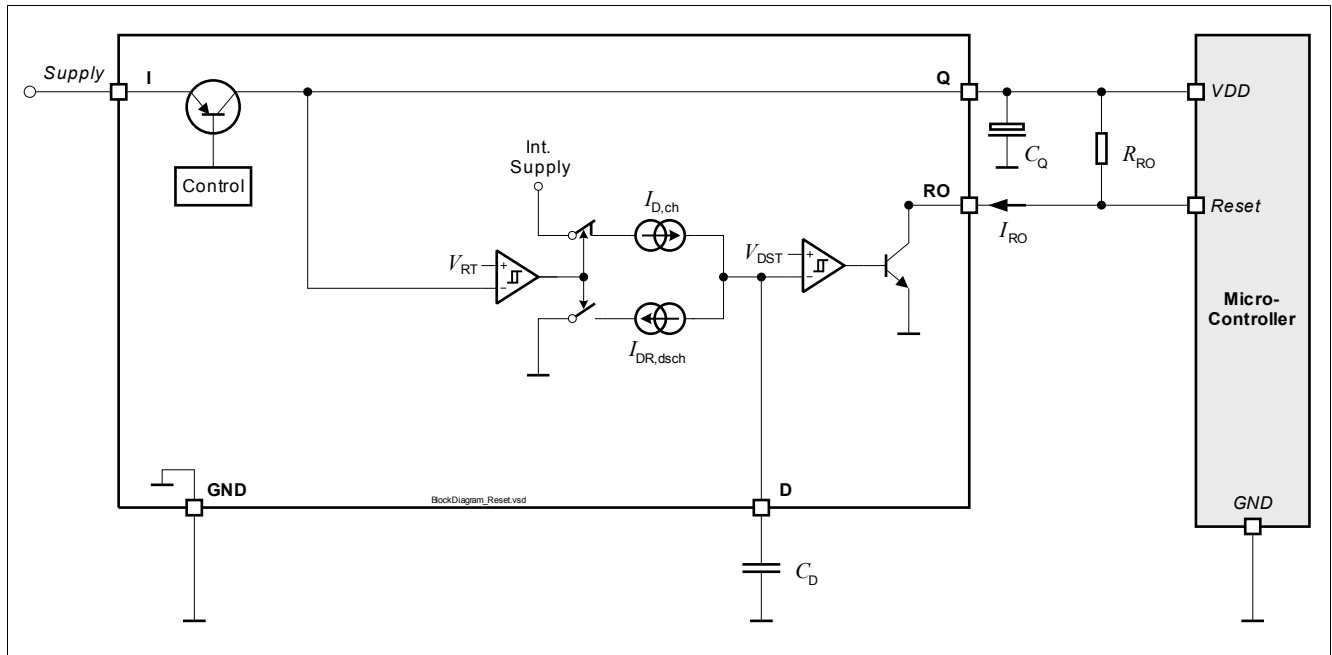

Figure 5 Block Diagram Reset Function

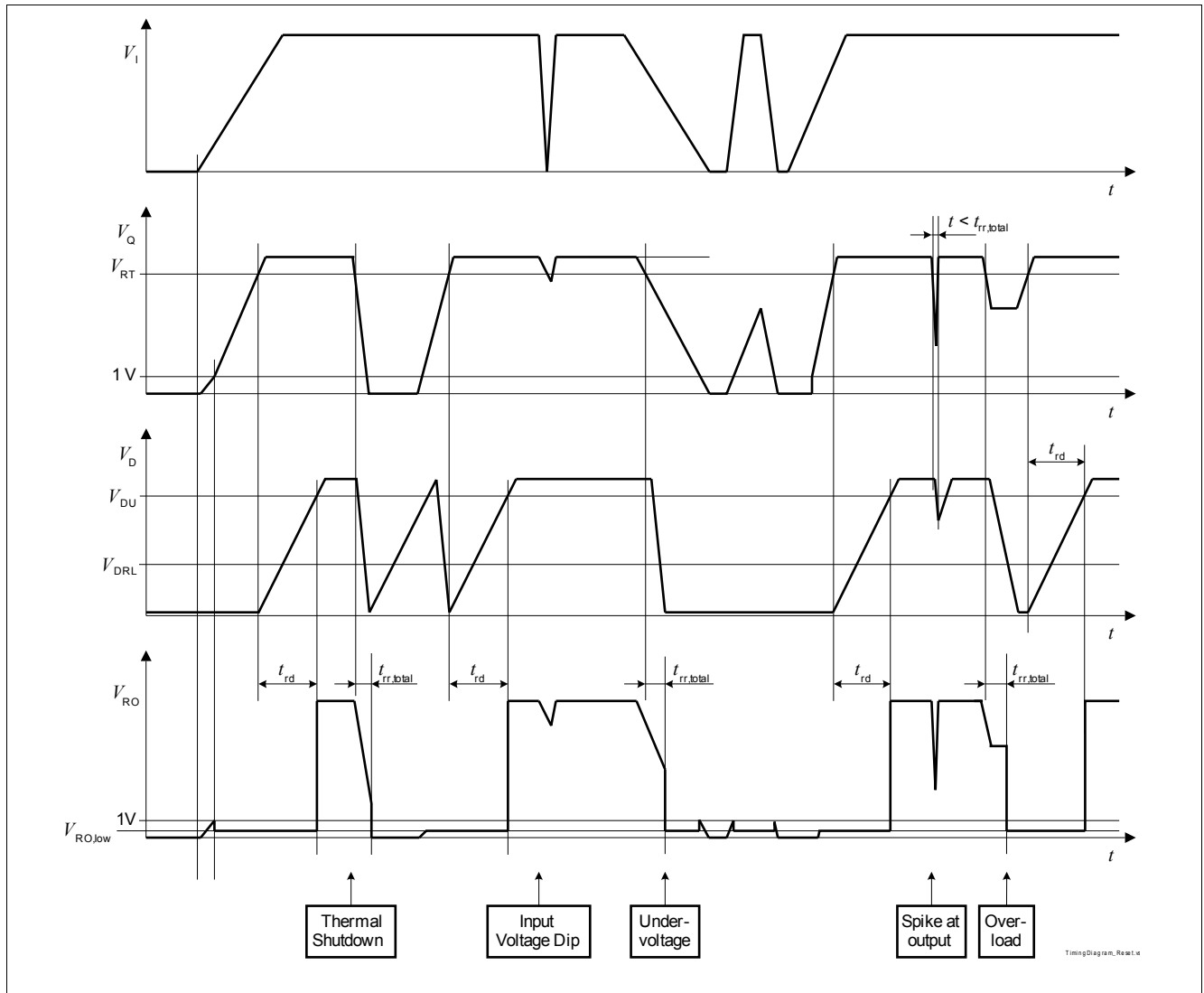

Figure 6 Timing Diagram Reset

Block Description and Electrical Characteristics

Table 6 Electrical Characteristics Reset Function

$V_1 = 13.5\text{ V}$, $-40\text{ }^\circ\text{C} \leq T_j \leq 150\text{ }^\circ\text{C}$, all voltages with respect to ground, positive current flowing into pin (unless otherwise specified)

Parameter	Symbol	Values			Unit	Note / Test Condition	Number
		Min.	Typ.	Max.			
Output Undervoltage Reset							
Output Undervoltage Reset Switching Thresholds	V_{RT}	4.5	4.65	4.8	V	V_Q decreasing	P_5.3.1
Reset Output RO							
Reset Output Low Voltage	$V_{RO,low}$	–	0.2	0.4	V	$1\text{ V} \leq V_Q \leq V_{RT}$; $I_{RO} = 0.2\text{ mA}$	P_5.3.2
Reset Output Sink Current Capability	$I_{RO,max}$	0.2	–	–	mA	$1\text{ V} \leq V_Q \leq V_{RT}$; $V_{RO} = 5\text{ V}$	P_5.3.3
Reset Output Leakage Current	$I_{RO,leak}$	–	0	10	μA	$V_{RO} = 5\text{ V}$	P_5.3.4
Reset Output External Pull-up Resistor to V_Q	R_{RO}	5	–	–	k Ω	$1\text{ V} \leq V_Q \leq V_{RT}$; $V_{RO} \leq 0.4\text{ V}$	P_5.3.5
Reset Delay Timing							
Power On Reset Delay Time	t_{rd}	10	16	22	ms	$C_D = 47\text{ nF}$	P_5.3.6
Upper Delay Switching Threshold	V_{DU}	–	1.8	–	V	–	P_5.3.7
Lower Delay Switching Threshold	V_{DRL}	–	0.65	–	V	–	P_5.3.8
Delay Capacitor Charge Current	$I_{D,ch}$	–	5.5	–	μA	$V_D = 1\text{ V}$	P_5.3.9
Delay Capacitor Reset Discharge Current	$I_{D,dch}$	–	100	–	mA	$V_D = 1\text{ V}$	P_5.3.10
Delay Capacitor Discharge Time	$t_{rr,d}$	–	0.5	1	μs	Calculated Value: $t_{rr,d} = C_D * (V_{DU} - V_{DRL}) / I_{D,dch}$ $C_D = 47\text{ nF}$	P_5.3.11
Internal Reset Reaction Time	$t_{rr,int}$	–	4	7	μs	$C_D = 0\text{ nF}^{1)}$	P_5.3.12
Reset Reaction Time	$t_{rr,total}$	–	4.5	8	μs	Calculated Value: $t_{rr,total} = t_{rr,int} + t_{rr,d}$ $C_D = 47\text{ nF}$	P_5.3.13

1) parameter not subject to production test; specified by design

Typical Performance Characteristics

Undervoltage Reset Switching Threshold V_{RT} versus T_j

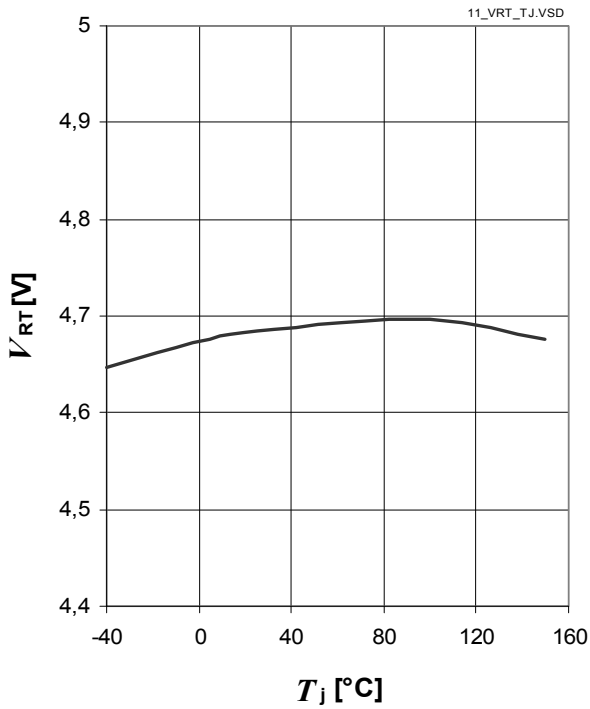

Power On Reset Delay Time t_{rd} versus Junction Temperature T_j

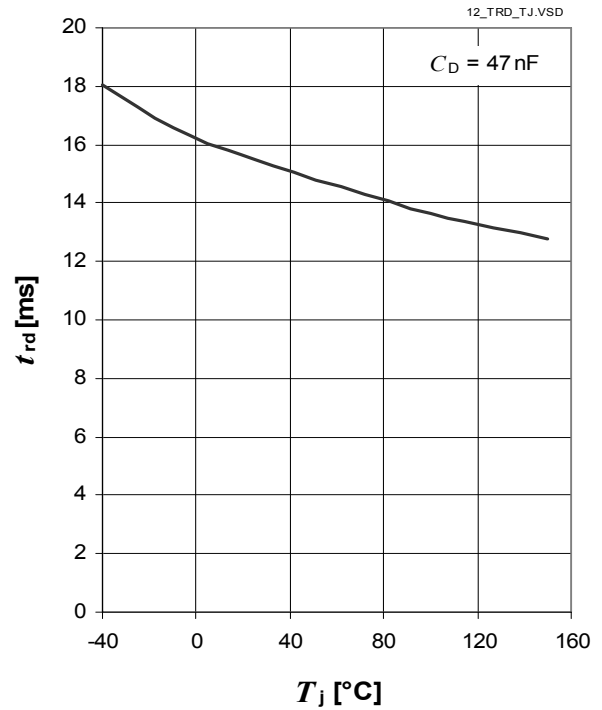

Power On Reset Delay Time t_{rd} versus Capacitance C_D

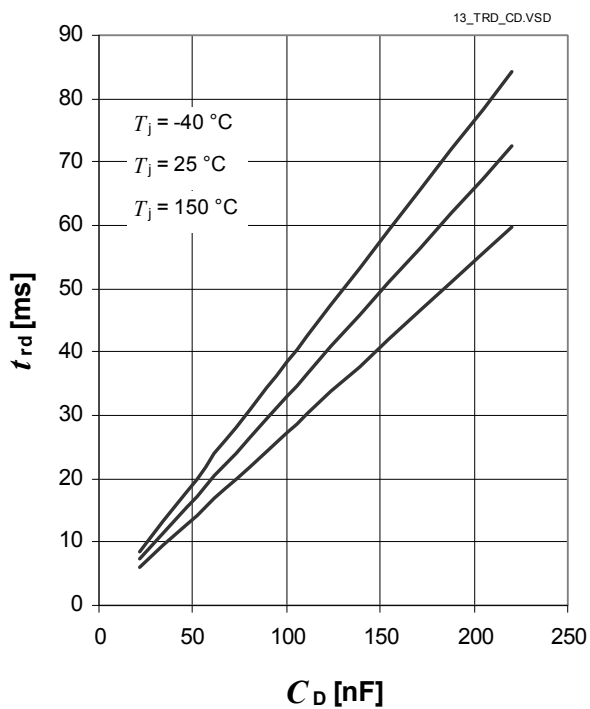

Internal Reset Reaction Time $t_{rr,int}$ versus Junction Temperature T_j

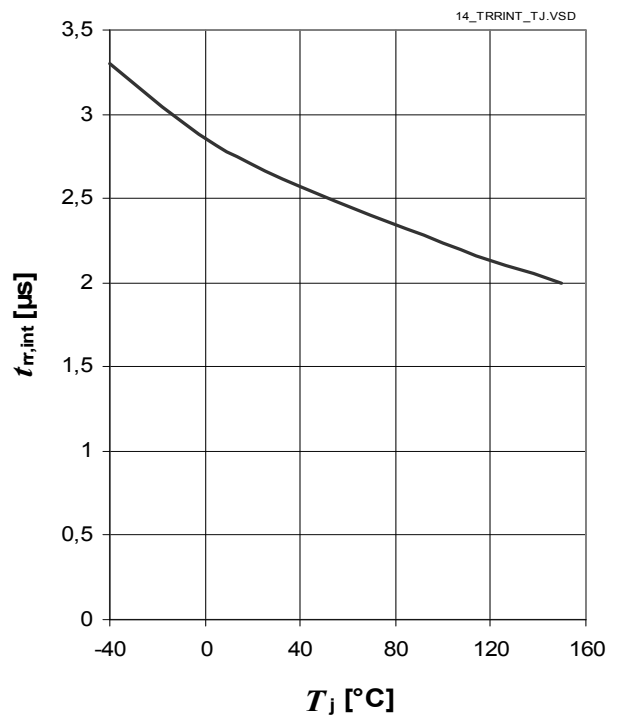

Delay Capacitor Discharge Time $t_{rr,d}$ versus Junction Temperature T_j

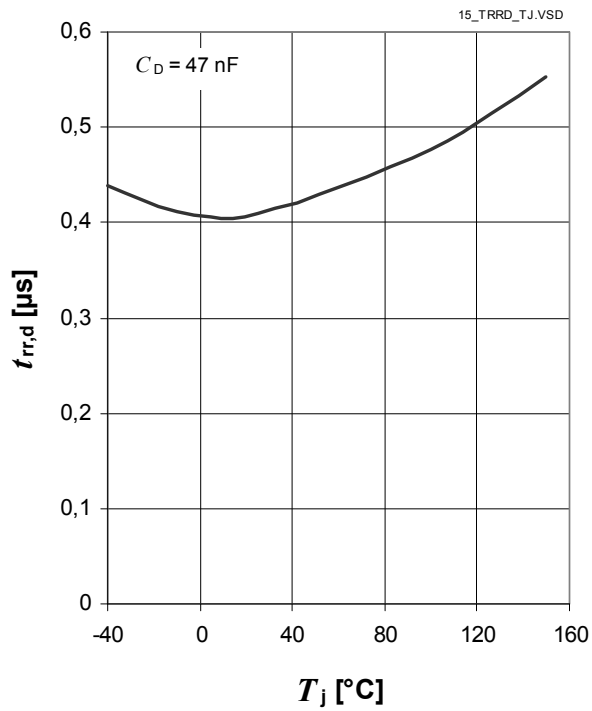

6 Application Information

Note: The following information is given as a hint for the implementation of the device only and shall not be regarded as a description or warranty of a certain functionality, condition or quality of the device.

6.1 Application Diagram

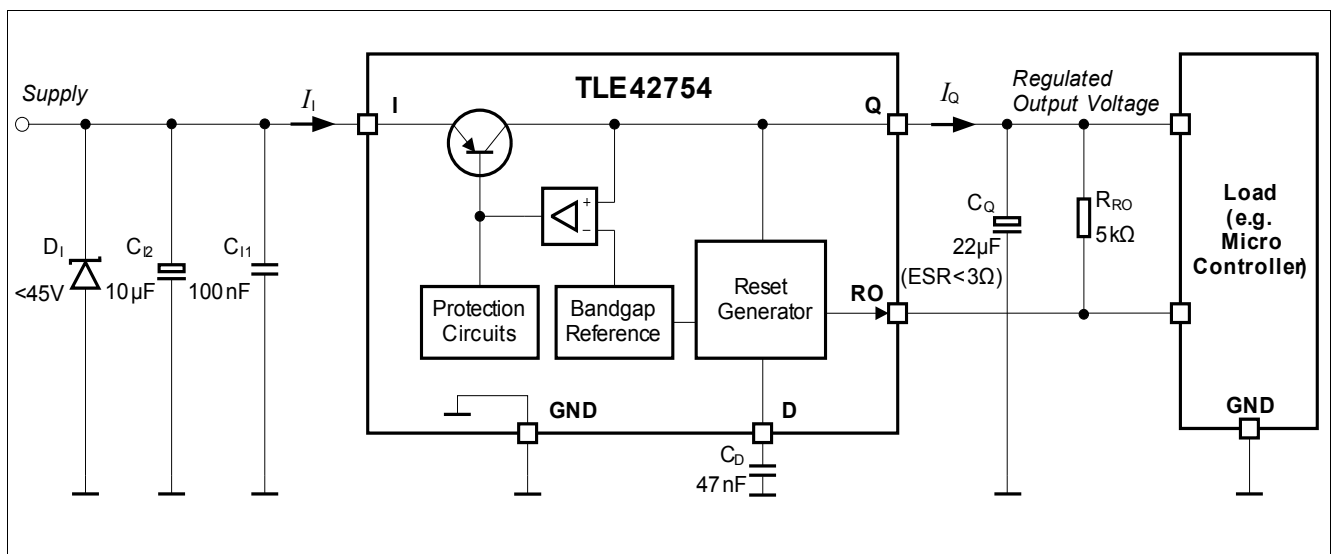

Figure 7 Application Diagram

6.2 Selection of External Components

6.2.1 Input Pin

The typical input circuitry for a linear voltage regulator is shown in the application diagram above.

A ceramic capacitor at the input, in the range of 100nF to 470nF, is recommended to filter out the high frequency disturbances imposed by the line e.g. ISO pulses 3a/b. This capacitor must be placed very close to the input pin of the linear voltage regulator on the PCB.

An aluminum electrolytic capacitor in the range of 10µF to 470µF is recommended as an input buffer to smooth out high energy pulses, such as ISO pulse 2a. This capacitor should be placed close to the input pin of the linear voltage regulator on the PCB.

An overvoltage suppressor diode can be used to further suppress any high voltage beyond the maximum rating of the linear voltage regulator and protect the device against any damage due to over-voltage.

The external components at the input are not mandatory for the operation of the voltage regulator, but they are recommended in case of possible external disturbances.

6.2.2 Output Pin

An output capacitor is mandatory for the stability of linear voltage regulators.

The requirement to the output capacitor is given in “[Functional Range](#)” on Page 8. The graph “[Output Capacitor Series Resistor ESR\(C_Q\) versus Output Current I_Q](#)” on Page 13 shows the stable operation range of the device.

TLE42754 is designed to be stable with extremely low ESR capacitors. According to the automotive environment, ceramic capacitors with X5R or X7R dielectrics are recommended.

The output capacitor should be placed as close as possible to the regulator's output and GND pins and on the same side of the PCB as the regulator itself.

In case of rapid transients of input voltage or load current, the capacitance should be dimensioned in accordance and verified in the real application that the output stability requirements are fulfilled.

6.3 Thermal Considerations

Knowing the input voltage, the output voltage and the load profile of the application, the total power dissipation can be calculated:

$$P_D = (V_I - V_Q) \times I_Q + V_I \times I_q \tag{4}$$

with

- P_D : continuous power dissipation
- V_I : input voltage
- V_Q : output voltage
- I_Q : output current
- I_q : quiescent current

The maximum acceptable thermal resistance R_{thJA} can then be calculated:

$$R_{thJA, max} = \frac{T_{j, max} - T_a}{P_D} \tag{5}$$

with

- $T_{j, max}$: maximum allowed junction temperature
- T_a : ambient temperature

Based on the above calculation the proper PCB type and the necessary heat sink area can be determined with reference to the specification in **“Thermal Resistance” on Page 9**.

Example

Application conditions:

$$V_I = 13.5 \text{ V}$$

$$V_Q = 5 \text{ V}$$

$$I_Q = 250 \text{ mA}$$

$$T_a = 85 \text{ °C}$$

Calculation of $R_{thJA, max}$:

$$\begin{aligned} P_D &= (V_I - V_Q) \cdot I_Q + V_I \cdot I_q \\ &= (13.5 \text{ V} - 5 \text{ V}) \cdot 250 \text{ mA} + 13.5 \text{ V} \cdot 10 \text{ mA} \\ &= 2.125 \text{ W} + 0.135 \text{ W} \\ &= 2.26 \text{ W} \end{aligned}$$

$$\begin{aligned} R_{\text{thJA,max}} &= (T_{\text{j,max}} - T_{\text{a}}) / P_{\text{D}} \\ &= (150 \text{ }^{\circ}\text{C} - 85 \text{ }^{\circ}\text{C}) / 2.26 \text{ W} \\ &= 28.76 \text{ K/W} \end{aligned}$$

As a result, the PCB design must ensure a thermal resistance R_{thJA} lower than 28.76 K/W. By considering TLE42754G (PG-TO263-5 package) and according to **“Thermal Resistance” on Page 9**, only the FR4 2s2p board is applicable.

6.4 Reverse Polarity Protection

TLE42754 is self protected against reverse polarity faults and allows negative supply voltage. External reverse polarity diode is not needed. However, the absolute maximum ratings of the device as specified in **“Absolute Maximum Ratings” on Page 7** must be kept.

The reverse voltage causes several small currents to flow into the IC hence increasing its junction temperature. As the thermal shut down circuitry does not work in the reverse polarity condition, designers have to consider this in their thermal design.

7 Package Outlines

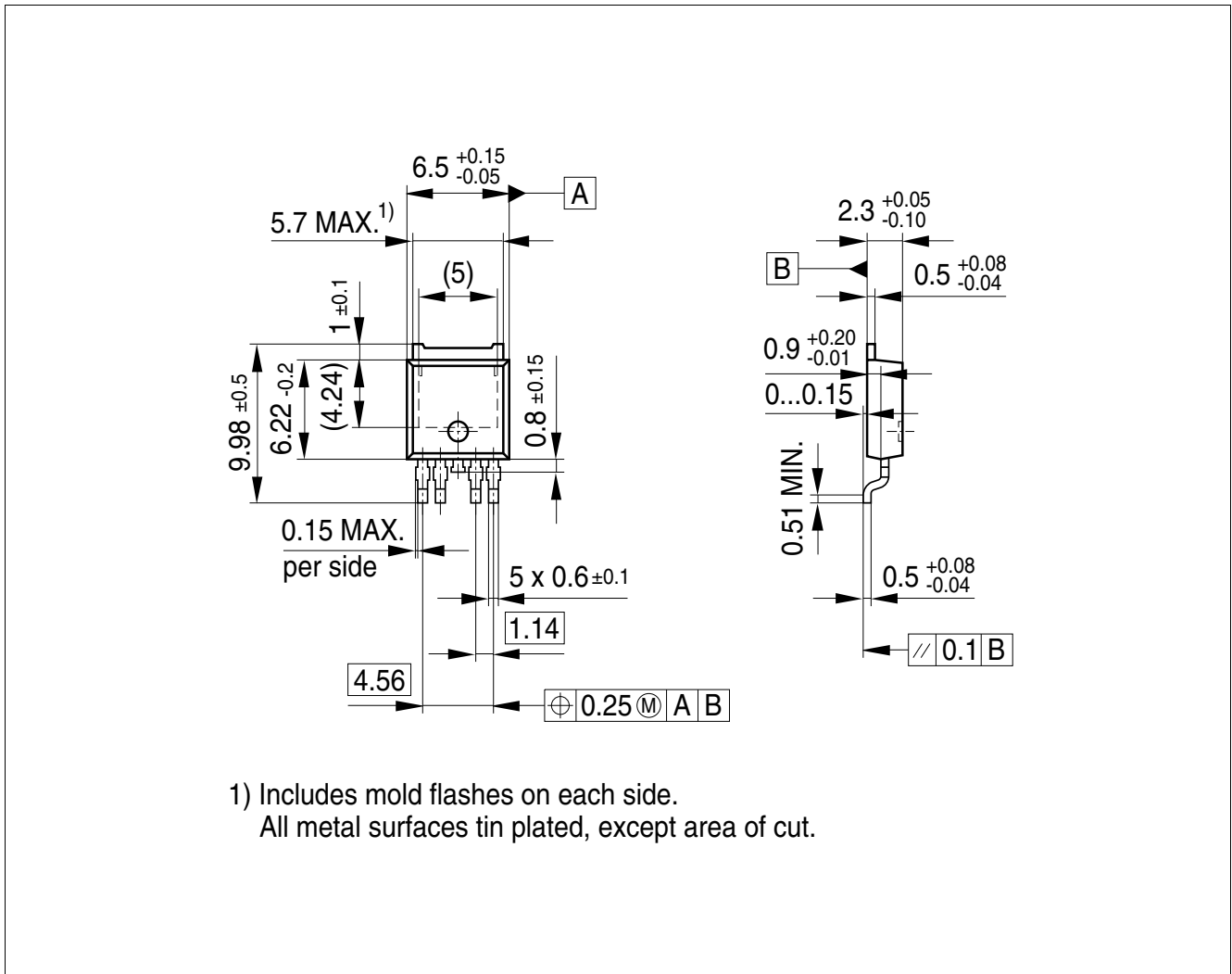
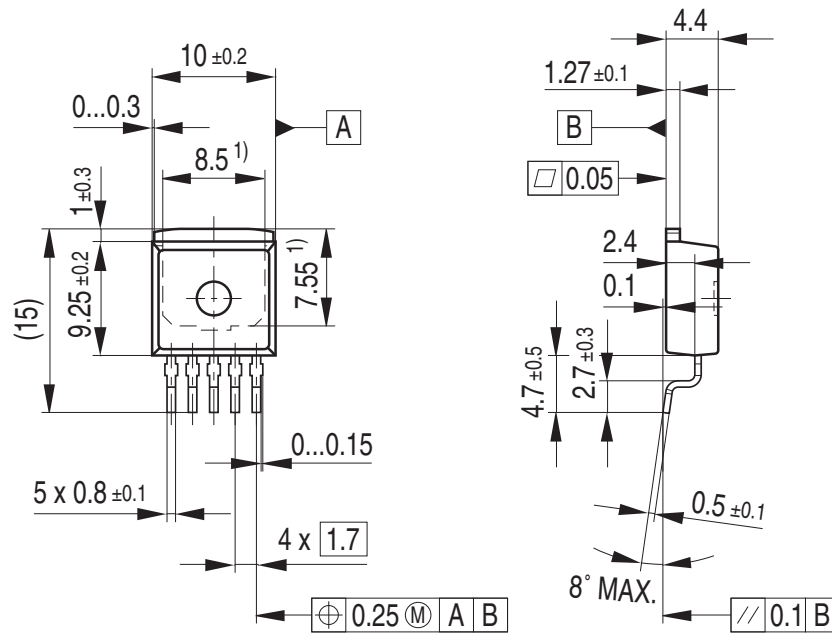

Figure 8 PG-TO252-5



1) Typical

Metal surface min. X = 7.25, Y = 6.9

All metal surfaces tin plated, except area of cut.

GPT09113

Figure 9 PG-TO263-5

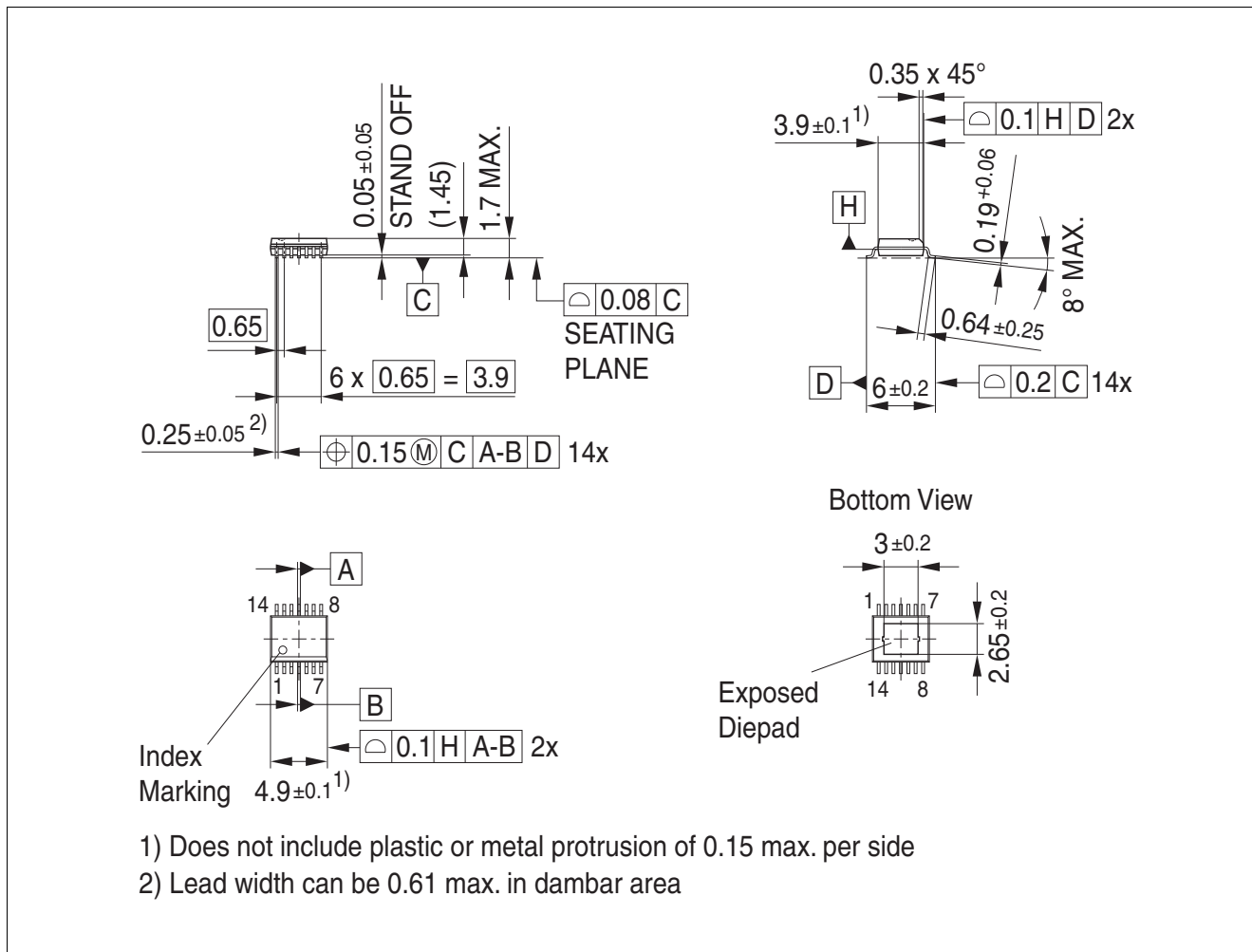

Figure 10 PG-SSOP-14 exposed pad

Green Product (RoHS compliant)

To meet the world-wide customer requirements for environmentally friendly products and to be compliant with government regulations the device is available as a green product. Green products are RoHS-Compliant (i.e Pb-free finish on leads and suitable for Pb-free soldering according to IPC/JEDEC J-STD-020).

For further information on alternative packages, please visit our website:
<http://www.infineon.com/packages>.

Dimensions in mm

8 Revision History

Version	Date	Changes
1.2	2014-07-03	<p>“Application Information” on Page 22 added. PG-SSOP-14 EP package outline updated.</p>
1.11	2012-01-20	<p>Page 19: Condition of Parameter Delay Capacitor Discharge Time, Internal Reset Reaction Time and Reset Reaction Time corrected. Parameters are valid for all package variants. No need to limit the Measurement conditions.</p> <p>Coverpage updated.</p>
1.1	2008-09-24	<p>data sheet updated with new package variant in PG-SSOP-14 exposed pad:</p> <p>In “Overview” on Page 2 package graphic and sales name with marking added</p> <p>In Table 4.3 “Thermal Resistance” on Page 9 values for package PG-SSOP-14 exposed pad added</p> <p>In “Package Outlines” on Page 25 Outlines for package PG-SSOP-14 exposed pad added</p>
1.0	2008-05-29	final data sheet

Edition 2014-07-03

**Published by
Infineon Technologies AG
81726 Munich, Germany**

**© 2014 Infineon Technologies AG
All Rights Reserved.**

Legal Disclaimer

The information given in this document shall in no event be regarded as a guarantee of conditions or characteristics. With respect to any examples or hints given herein, any typical values stated herein and/or any information regarding the application of the device, Infineon Technologies hereby disclaims any and all warranties and liabilities of any kind, including without limitation, warranties of non-infringement of intellectual property rights of any third party.

Information

For further information on technology, delivery terms and conditions and prices, please contact the nearest Infineon Technologies Office (www.infineon.com).

Warnings

Due to technical requirements, components may contain dangerous substances. For information on the types in question, please contact the nearest Infineon Technologies Office.

Infineon Technologies components may be used in life-support devices or systems only with the express written approval of Infineon Technologies, if a failure of such components can reasonably be expected to cause the failure of that life-support device or system or to affect the safety or effectiveness of that device or system. Life support devices or systems are intended to be implanted in the human body or to support and/or maintain and sustain and/or protect human life. If they fail, it is reasonable to assume that the health of the user or other persons may be endangered.