

Telecom “Tip and Ring” X7R Dielectric, 250 VDC (Commercial Grade)

Overview

KEMET’s 250 V DC Tip and Ring MLCCs in X7R dielectric are designed and rated for telecommunication ringer circuits where the capacitor is used to block -48 V to -52 V DC of line voltage and pass a 16 – 25 Hz AC signal pulse of 70 VRMs to 90 VRMs. Serving as an excellent replacement for high voltage leaded film devices, these smaller surface mount technology footprints save valuable board space which is critical when creating new designs.

KEMET Tip and Ring capacitors feature a 125°C maximum operating temperature and are considered “temperature stable.” The Electronics Components, Assemblies & Materials Association (EIA) characterizes X7R dielectric as a Class II

material. Components of this classification are fixed, ceramic dielectric capacitors suited for bypass and decoupling applications or for frequency discriminating circuits where Q and stability of capacitance characteristics are not critical. X7R dielectric exhibits a predictable change in capacitance with respect to time and voltage and boasts a minimal change in capacitance with reference to ambient temperature. Capacitance change is limited to $\pm 15\%$ from -55°C to +125°C.

These devices are able to withstand today’s higher lead-free reflow processing temperatures and offer superior high frequency filtering characteristics and low ESR.

Benefits

- -55°C to +125°C operating temperature range
- Pb-Free and RoHS Compliant
- EIA 0805, 1206, 1210, 1812, 1825, 2220, and 2225 case sizes
- DC voltage rating of 250 V
- Capacitance offerings ranging from 1,000 pF to 6.8 μ F
- Available capacitance tolerances of $\pm 10\%$ and $\pm 20\%$
- Non-polar device, minimizing installation concerns
- 100% pure matte tin-plated termination finish that allows for excellent solderability
- SnPb termination finish option available upon request (5% minimum)
- Flexible termination option available upon request

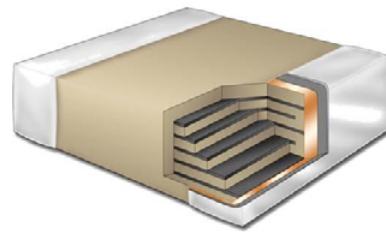

Ordering Information

C	1825	C	105	K	A	R	A	C	TU
Ceramic	Case Size (L" x W")	Specification/ Series	Capacitance Code (pF)	Capacitance Tolerance	Voltage	Dielectric	Failure Rate/ Design	Termination Finish ¹	Packaging/Grade (C-Spec) ²
	0805 1206 1210 1812 1825 2220 2225	C = Standard X = Flexible Termination	2 Significant Digits + Number of Zeros	J = $\pm 5\%$ K = $\pm 10\%$ M = $\pm 20\%$	A = 250 V	R = X7R	A = N/A	C = 100% Matte Sn L = SnPb (5% minimum)	Blank = Bulk TU = 7" Reel Unmarked TM = 7" Reel Marked

¹ Additional termination finish options may be available. Contact KEMET for details.

² Additional reeling or packaging options may be available. Contact KEMET for details.

Dimensions – Millimeters (Inches) – Standard Termination

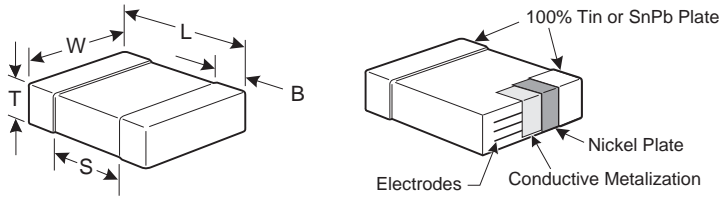

EIA Size Code	Metric Size Code	L Length	W Width	T Thickness	B Bandwidth	S Separation Minimum	Mounting Technique
0805	2012	2.00 (.079) ± 0.20 (.008)	1.25 (.049) ± 0.20 (.008)	See Table 2 for Thickness	0.50 (0.02) ± 0.25 (.010)	0.75 (.030)	Solder Wave or Solder Reflow
1206	3216	3.20 (.126) ± 0.20 (.008)	1.60 (.063) ± 0.20 (.008)		0.50 (0.02) ± 0.25 (.010)	N/A	
1210	3225	3.20 (.126) ± 0.20 (.008)	2.50 (.098) ± 0.20 (.008)		0.50 (0.02) ± 0.25 (.010)		Solder Reflow Only
1812	4532	4.50 (.177) ± 0.30 (.012)	3.20 (.126) ± 0.30 (.012)		0.60 (.024) ± 0.35 (.014)		
1825	4564	4.50 (.177) ± 0.30 (.012)	6.40 (.252) ± 0.40 (.016)		0.60 (.024) ± 0.35 (.014)		
2220	5650	5.70 (.224) ± 0.40 (.016)	5.00 (.197) ± 0.40 (.016)		0.60 (.024) ± 0.35 (.014)		
2225	5664	5.60 (.220) ± 0.40 (.016)	6.40 (.248) ± 0.40 (.016)		0.60 (.024) ± 0.35 (.014)		

Dimensions – Millimeters (Inches) – Flexible Termination

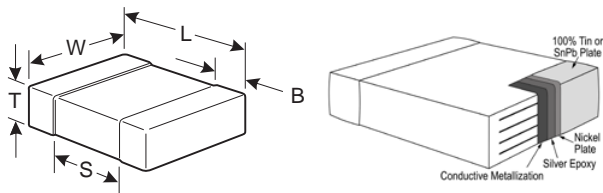

EIA Size Code	Metric Size Code	L Length	W Width	T Thickness	B Bandwidth	S Separation Minimum	Mounting Technique
0805	2012	2.00 (.079) ± 0.20 (.008)	1.25 (.049) ± 0.20 (.008)	See Table 2 for Thickness	0.50 (0.02) ± 0.25 (.010)	0.75 (.030)	Solder Wave or Solder Reflow
1206	3216	3.30 (.130) ± 0.40 (.016)	1.60 (.063) ± 0.20 (.008)		0.60 (.024) ± 0.25 (.010)	N/A	
1210	3225	3.30 (.130) ± 0.40 (.016)	2.50 (.098) ± 0.20 (.008)		0.60 (.024) ± 0.25 (.010)		Solder Reflow Only
1812	4532	4.50 (.178) ± 0.40 (.016)	3.20 (.126) ± 0.30 (.012)		0.70 (.028) ± 0.35 (.014)		
1825	4564	4.60 (.181) ± 0.40 (.016)	6.40 (.252) ± 0.40 (.016)		0.70 (.028) ± 0.35 (.014)		
2220	5650	5.90 (.232) ± 0.75 (.030)	5.00 (.197) ± 0.40 (.016)		0.70 (.028) ± 0.35 (.014)		
2225	5664	5.90 (.232) ± 0.75 (.030)	6.40 (.248) ± 0.40 (.016)		0.70 (.028) ± 0.35 (.014)		

Applications

Typical applications include telecommunication ringing circuits, switch mode power supply snubber circuits, high voltage DC blocking and high voltage coupling. Markets include telephone lines, analog and digital modems, facsimile machines, wireless base stations, cable and digital video recording set-top boxes, satellite dishes, high voltage power supply, DC/DC converters, and Ethernet, POS and ATM hardware.

Qualification/Certification

Commercial Grade products are subject to internal qualification. Details regarding test methods and conditions are referenced in Table 4, Performance & Reliability.

Environmental Compliance

Pb-Free and RoHS Compliant (excluding SnPb termination finish option).



RoHS Compliant

Electrical Parameters/Characteristics

Item	Parameters/Characteristics
Operating Temperature Range	-55°C to +125°C
Capacitance Change with Reference to +25°C and 0 VDC Applied (TCC)	±15%
Aging Rate (Maximum % Capacitance Loss/Decade Hour)	3.0%
Dielectric Withstanding Voltage (DWV)	250% of rated voltage (5 ±1 seconds and charge/discharge not exceeding 50 mA)
Dissipation Factor (DF) Maximum Limit @ 25°C	5% (6.3 and 10 V), 3.5% (16 and 25 V) and 2.5% (50 to 250 V)
Insulation Resistance (IR) Limit @ 25°C	See Insulation Resistance Limit Table (Rated voltage applied for 120 ±5 seconds @ 25°C)

Regarding aging rate: Capacitance measurements (including tolerance) are indexed to a referee time of 1,000 hours.

To obtain IR limit, divide $M\Omega \cdot \mu F$ value by the capacitance and compare to $G\Omega$ limit. Select the lower of the two limits.

Capacitance and dissipation factor (DF) measured under the following conditions:

1 kHz ±50 Hz and 1.0 ± 0.2 Vrms if capacitance ≤ 10 μF

120 Hz ±10 Hz and 0.5 ± 0.1 Vrms if capacitance > 10 μF

Note: When measuring capacitance it is important to ensure the set voltage level is held constant. The HP4284 and Agilent E4980 have a feature known as Automatic Level Control (ALC). The ALC feature should be switched to "ON."

Post Environmental Limits

High Temperature Life, Biased Humidity, Moisture Resistance					
Dielectric	Rated DC Voltage	Capacitance Value	Dissipation Factor (Maximum %)	Capacitance Shift	Insulation Resistance
X7R	> 25	All	3.0	±20%	10% of Initial Limit
	16/25		5.0		
	< 16		7.5		

Insulation Resistance Limit Table

EIA Case Size	1,000 Megohm Microfarads or 100 GΩ	500 Megohm Microfarads or 10 GΩ
0201	N/A	ALL
0402	< 0.012 μF	≥ 0.012 μF
0603	< 0.047 μF	≥ 0.047 μF
0805	< 0.047 μF	≥ 0.047 μF
1206	< 0.22 μF	≥ 0.22 μF
1210	< 0.39 μF	≥ 0.39 μF
1808	ALL	N/A
1812	< 2.2 μF	≥ 2.2 μF
1825	ALL	N/A
2220	< 10 μF	≥ 10 μF
2225	ALL	N/A

Table 1 – Capacitance Range/Selection Waterfall (0805 – 2225 Case Sizes)

Capacitance	Capacitance Code	Series			C0805	C1206	C1210	C1812	C1825	C2220	C2225
		Voltage Code			A	A	A	A	A	A	A
		Voltage DC			250	250	250	250	250	250	250
		Capacitance Tolerance			Product Availability and Chip Thickness Codes See Table 2 for Chip Thickness Dimensions						
180 pF	181	J	K	M	DC						
220 pF	221	J	K	M	DC						
270 pF	271	J	K	M	DC						
330 pF	331	J	K	M	DC						
390 pF	391	J	K	M	DC						
470 pF	471	J	K	M	DC						
560 pF	561	J	K	M	DC						
680 pF	681	J	K	M	DC						
820 pF	821	J	K	M	DC						
1000 pF	102	J	K	M	DC	EB					
1200 pF	122	J	K	M	DC	EB					
1500 pF	152	J	K	M	DC	EB					
1800 pF	182	J	K	M	DC	EB					
2200 pF	222	J	K	M	DC	EB	FB				
2700 pF	272	J	K	M	DC	EB	FB				
3300 pF	332	J	K	M	DC	EB	FB				
3900 pF	392	J	K	M	DC	EB	FB				
4700 pF	472	J	K	M	DC	EB	FB				
5600 pF	562	J	K	M	DC	EB	FB				
6800 pF	682	J	K	M	DC	EB	FB	GB			
8200 pF	822	J	K	M	DC	EB	FB	GB			
10000 pF	103	J	K	M	DC	EB	FB	GB			
12000 pF	123	J	K	M	DC	EB	FB	GB			
15000 pF	153	J	K	M	DC	EB	FB	GB			
18000 pF	183	J	K	M	DC	EB	FB	GB			
22000 pF	223	J	K	M	DC	EB	FB	GB	HB		
27000 pF	273	J	K	M		EB	FB	GB	HB		
33000 pF	333	J	K	M		EB	FB	GB	HB		
39000 pF	393	J	K	M		EB	FB	GB	HB		
47000 pF	473	J	K	M		ED	FC	GB	HB		
56000 pF	563	J	K	M		ED	FC	GB	HB		
68000 pF	683	J	K	M		ED	FC	GB	HB		
82000 pF	823	J	K	M		ED	FF	GB	HB	JC	
0.1 µF	104	J	K	M		EM	FG	GB	HB	JC	KC
0.12 µF	124	J	K	M				GB	HB	JC	KC
0.15 µF	154	J	K	M				GE	HB	JC	KC
0.18 µF	184	J	K	M				GG	HB	JC	KC
0.22 µF	224	J	K	M				GG	HB	JC	KC
0.27 µF	274	J	K	M				GG	HB	JC	KC
0.33 µF	334	J	K	M				GG	HB	JC	KC
0.39 µF	394	J	K	M				GG	HD	JC	KC
0.47 µF	474	J	K	M				GJ	HD	JC	KD
0.56 µF	564	J	K	M					HD	JD	KD
0.68 µF	684	J	K	M					HD	JD	KD
0.82 µF	824	J	K	M					HF	JF	KE
1 µF	105	J	K	M					HF	JF	KE
1.2 µF	125	J	K	M							KE
Capacitance	Capacitance Code	Voltage DC			250	250	250	250	250	250	250
		Voltage Code			A	A	A	A	A	A	A
		Series			C0805	C1206	C1210	C1812	C1825	C2220	C2225

Table 2 – Chip Thickness/Packaging Quantities

Thickness Code	Case Size	Thickness ± Range (mm)	Paper Quantity		Plastic Quantity	
			7" Reel	13" Reel	7" Reel	13" Reel
DC	0805	0.78 ± 0.10	4,000	10,000	0	0
EB	1206	0.78 ± 0.10	4,000	10,000	4,000	10,000
ED	1206	1.00 ± 0.10	0	0	2,500	10,000
EM	1206	1.25 ± 0.15	0	0	2,500	10,000
FB	1210	0.78 ± 0.10	0	0	4,000	10,000
FC	1210	0.90 ± 0.10	0	0	4,000	10,000
FF	1210	1.10 ± 0.10	0	0	2,500	10,000
FG	1210	1.25 ± 0.15	0	0	2,500	10,000
GB	1812	1.00 ± 0.10	0	0	1,000	4,000
GE	1812	1.30 ± 0.10	0	0	1,000	4,000
GG	1812	1.55 ± 0.10	0	0	1,000	4,000
GJ	1812	1.70 ± 0.15	0	0	1,000	4,000
HB	1825	1.10 ± 0.15	0	0	1,000	4,000
HD	1825	1.30 ± 0.15	0	0	1,000	4,000
HF	1825	1.50 ± 0.15	0	0	1,000	4,000
JC	2220	1.10 ± 0.15	0	0	1,000	4,000
JD	2220	1.30 ± 0.15	0	0	1,000	4,000
JF	2220	1.50 ± 0.15	0	0	1,000	4,000
KC	2225	1.10 ± 0.15	0	0	1,000	4,000
KD	2225	1.30 ± 0.15	0	0	1,000	4,000
KE	2225	1.40 ± 0.15	0	0	1,000	4,000
Thickness Code	Case Size	Thickness ± Range (mm)	7" Reel	13" Reel	7" Reel	13" Reel
			Paper Quantity		Plastic Quantity	

Package quantity based on finished chip thickness specifications.

Table 3A – Land Pattern Design Recommendations per IPC–7351 – Standard Termination

EIA Size Code	Metric Size Code	Density Level A: Maximum (Most) Land Protrusion (mm)					Density Level B: Median (Nominal) Land Protrusion (mm)					Density Level C: Minimum (Least) Land Protrusion (mm)				
		C	Y	X	V1	V2	C	Y	X	V1	V2	C	Y	X	V1	V2
0805	2012	1.00	1.35	1.55	4.40	2.60	0.90	1.15	1.45	3.50	2.00	0.75	0.95	1.35	2.80	1.70
1206	3216	1.60	1.35	1.90	5.60	2.90	1.50	1.15	1.80	4.70	2.30	1.40	0.95	1.70	4.00	2.00
1210	3225	1.60	1.35	2.80	5.65	3.80	1.50	1.15	2.70	4.70	3.20	1.40	0.95	2.60	4.00	2.90
1210 ¹	3225	1.50	1.60	2.90	5.60	3.90	1.40	1.40	2.80	4.70	3.30	1.30	1.20	2.70	4.00	3.00
1812	4532	2.15	1.60	3.60	6.90	4.60	2.05	1.40	3.50	6.00	4.00	1.95	1.20	3.40	5.30	3.70
1825	4564	2.15	1.60	6.90	6.90	7.90	2.05	1.40	6.80	6.00	7.30	1.95	1.20	6.70	5.30	7.00
2220	5650	2.75	1.70	5.50	8.20	6.50	2.65	1.50	5.40	7.30	5.90	2.55	1.30	5.30	6.60	5.60
2225	5664	2.70	1.70	6.90	8.10	7.90	2.60	1.50	6.80	7.20	7.30	2.50	1.30	6.70	6.50	7.00

¹ Only for capacitance values ≥ 22 μF

Table 3B – Land Pattern Design Recommendations per IPC–7351 – Flexible Termination

EIA Size Code	Metric Size Code	Density Level A: Maximum (Most) Land Protrusion (mm)					Density Level B: Median (Nominal) Land Protrusion (mm)					Density Level C: Minimum (Least) Land Protrusion (mm)				
		C	Y	X	V1	V2	C	Y	X	V1	V2	C	Y	X	V1	V2
0805	2012	1.00	1.35	1.55	4.40	2.60	0.90	1.15	1.45	3.50	2.00	0.80	0.95	1.35	2.80	1.70
1206	3216	1.60	1.65	1.90	5.90	2.90	1.50	1.45	1.80	5.00	2.30	1.40	1.25	1.70	4.30	2.00
1210	3225	1.60	1.65	2.80	5.90	3.80	1.50	1.45	2.70	5.00	3.20	1.40	1.25	2.60	4.30	2.90
1812	4532	2.10	1.80	3.60	7.00	4.60	2.00	1.60	3.50	6.10	4.00	1.90	1.40	3.40	5.40	3.70
1825	4564	2.15	1.80	6.90	7.10	7.90	2.05	1.60	6.80	6.20	7.30	1.95	1.40	6.70	5.50	7.00
2220	5650	2.85	2.10	5.50	8.80	6.50	2.75	1.90	5.40	7.90	5.90	2.65	1.70	5.30	7.20	5.60
2225	5664	2.85	2.10	6.90	8.80	7.90	2.75	1.90	6.80	7.90	7.30	2.65	1.70	6.70	7.20	7.00

Density Level A: For low-density product applications. Recommended for wave solder applications and provides a wider process window for reflow solder processes. KEMET only recommends wave soldering of EIA 0603, 0805 and 1206 case sizes.

Density Level B: For products with a moderate level of component density. Provides a robust solder attachment condition for reflow solder processes.

Density Level C: For high component density product applications. Before adapting the minimum land pattern variations the user should perform qualification testing based on the conditions outlined in IPC Standard 7351 (IPC–7351).

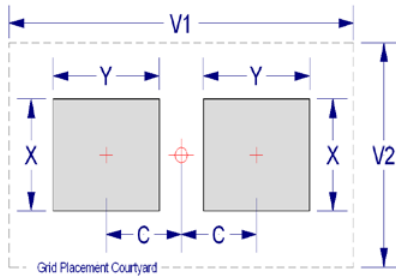

Soldering Process

Recommended Soldering Technique:

- Solder wave or solder reflow for EIA case sizes 0603, 0805 and 1206
- All other EIA case sizes are limited to solder reflow only

Recommended Soldering Profile:

- KEMET recommends following the guidelines outlined in IPC/JEDEC J–STD–020

Table 4 – Performance & Reliability: Test Methods and Conditions

Stress	Reference	Test or Inspection Method
Terminal Strength	JIS-C-6429	Appendix 1, Note: Force of 1.8 kg for 60 seconds.
Board Flex	JIS-C-6429	Appendix 2, Note: Standard termination system – 2.0 mm (minimum) for all except 3 mm for COG. Flexible termination system – 3.0 mm (minimum).
Solderability	J-STD-002	Magnification 50 X. Conditions:
		a) Method B, 4 hours @ 155°C, dry heat @ 235°C
		b) Method B @ 215°C category 3
		c) Method D, category 3 @ 260°C
Temperature Cycling	JESD22 Method JA-104	1,000 Cycles (-55°C to +125°C). Measurement at 24 hours +/- 2 hours after test conclusion.
Biased Humidity	MIL-STD-202 Method 103	Load Humidity: 1,000 hours 85°C/85% RH and rated voltage. Add 100 K ohm resistor. Measurement at 24 hours +/- 2 hours after test conclusion.
		Low Volt Humidity: 1,000 hours 85°C/85% RH and 1.5 V. Add 100 K ohm resistor. Measurement at 24 hours +/- 2 hours after test conclusion.
Moisture Resistance	MIL-STD-202 Method 106	t = 24 hours/cycle. Steps 7a and 7b not required. Unpowered. Measurement at 24 hours +/- 2 hours after test conclusion.
Thermal Shock	MIL-STD-202 Method 107	-55°C/+125°C. Note: Number of cycles required – 300, maximum transfer time – 20 seconds, dwell time – 15 minutes. Air – Air.
High Temperature Life	MIL-STD-202 Method 108 /EIA-198	1,000 hours at 125°C (85°C for X5R, Z5U and Y5V) with 2 X rated voltage applied.
Storage Life	MIL-STD-202 Method 108	150°C, 0 VDC for 1,000 hours.
Vibration	MIL-STD-202 Method 204	5 g's for 20 min., 12 cycles each of 3 orientations. Note: Use 8" X 5" PCB 0.031" thick 7 secure points on one long side and 2 secure points at corners of opposite sides. Parts mounted within 2" from any secure point. Test from 10 – 2,000 Hz
Mechanical Shock	MIL-STD-202 Method 213	Figure 1 of Method 213, Condition F.
Resistance to Solvents	MIL-STD-202 Method 215	Add aqueous wash chemical, OKEM Clean or equivalent.

Storage and Handling

Ceramic chip capacitors should be stored in normal working environments. While the chips themselves are quite robust in other environments, solderability will be degraded by exposure to high temperatures, high humidity, corrosive atmospheres, and long term storage. In addition, packaging materials will be degraded by high temperature– reels may soften or warp and tape peel force may increase. KEMET recommends that maximum storage temperature not exceed 40°C and maximum storage humidity not exceed 70% relative humidity. Temperature fluctuations should be minimized to avoid condensation on the parts and atmospheres should be free of chlorine and sulfur bearing compounds. For optimized solderability chip stock should be used promptly, preferably within 1.5 years of receipt.

Construction – Standard Termination

Reference	Item		Material	
A	Termination System	Finish	100% Matte Sn	SnPb (5% min)
B		Barrier Layer	Ni	
C		Base Metal	Cu	
D	Inner Electrode		Ni	
E	Dielectric Material		BaTiO ₃	

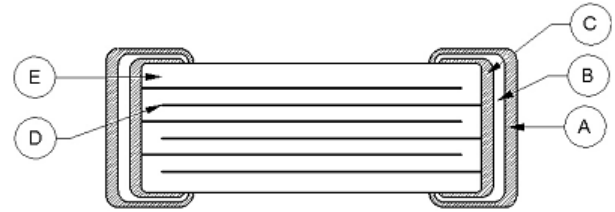

Note: Image is exaggerated in order to clearly identify all components of construction.

Construction – Flexible Termination

Reference	Item		Material	
A	Termination System	Finish	100% Matte Sn	SnPb (5% min)
B		Barrier Layer	Ni	
C		Epoxy Layer	Ag	
D	Base Metal		Cu	
E	Inner Electrode		Ni	
F	Dielectric Material		BaTiO ₃	

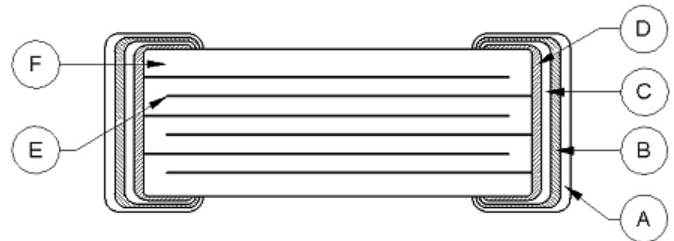

Note: Image is exaggerated in order to clearly identify all components of construction.

Capacitor Marking (Optional):

These surface mount multilayer ceramic capacitors are normally supplied unmarked. If required, they can be marked as an extra cost option. Marking is available on most KEMET devices but must be requested using the correct ordering code identifier(s). If this option is requested, two sides of the ceramic body will be laser marked with a "K" to identify KEMET, followed by two characters (per EIA-198 - see table below) to identify the capacitance value. EIA 0603 case size devices are limited to the "K" character only.

Marking appears in legible contrast. Illustrated below is an example of an MLCC with laser marking of "KA8", which designates a KEMET device with rated capacitance of 100 μ F. Orientation of marking is vendor optional.

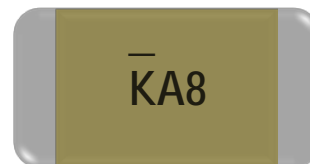

Laser marking option is not available on:

- COG, Ultra Stable X8R and Y5V dielectric devices
- EIA 0402 case size devices
- EIA 0603 case size devices with Flexible Termination option.
- KPS Commercial and Automotive Grade stacked devices.

Capacitance (pF) For Various Alpha/Numeral Identifiers										
Alpha Character	Numeral									
	9	0	1	2	3	4	5	6	7	8
	Capacitance (pF)									
A	0.1	10	10	100	1,000	10,000	100,000	1,000,000	10,000,000	100,000,000
B	0.11	1.1	11	110	1,100	11,000	110,000	1,100,000	11,000,000	110,000,000
C	0.12	12	12	120	1,200	12,000	120,000	1,200,000	12,000,000	120,000,000
D	0.13	13	13	130	1,300	13,000	130,000	1,300,000	13,000,000	130,000,000
E	0.15	15	15	150	1,500	15,000	150,000	1,500,000	15,000,000	150,000,000
F	0.16	16	16	160	1,600	16,000	160,000	1,600,000	16,000,000	160,000,000
G	0.18	18	18	180	1,800	18,000	180,000	1,800,000	18,000,000	180,000,000
H	0.2	20	20	200	2,000	20,000	200,000	2,000,000	20,000,000	200,000,000
J	0.22	22	22	220	2,200	22,000	220,000	2,200,000	22,000,000	220,000,000
K	0.24	24	24	240	2,400	24,000	240,000	2,400,000	24,000,000	240,000,000
L	0.27	27	27	270	2,700	27,000	270,000	2,700,000	27,000,000	270,000,000
M	0.3	30	30	300	3,000	30,000	300,000	3,000,000	30,000,000	300,000,000
N	0.33	33	33	330	3,300	33,000	330,000	3,300,000	33,000,000	330,000,000
P	0.36	36	36	360	3,600	36,000	360,000	3,600,000	36,000,000	360,000,000
Q	0.39	39	39	390	3,900	39,000	390,000	3,900,000	39,000,000	390,000,000
R	0.43	43	43	430	4,300	43,000	430,000	4,300,000	43,000,000	430,000,000
S	0.47	47	47	470	4,700	47,000	470,000	4,700,000	47,000,000	470,000,000
T	0.51	51	51	510	5,100	51,000	510,000	5,100,000	51,000,000	510,000,000
U	0.56	56	56	560	5,600	56,000	560,000	5,600,000	56,000,000	560,000,000
V	0.62	62	62	620	6,200	62,000	620,000	6,200,000	62,000,000	620,000,000
W	0.68	68	68	680	6,800	68,000	680,000	6,800,000	68,000,000	680,000,000
X	0.75	75	75	750	7,500	75,000	750,000	7,500,000	75,000,000	750,000,000
Y	0.82	82	82	820	8,200	82,000	820,000	8,200,000	82,000,000	820,000,000
Z	0.91	91	91	910	9,100	91,000	910,000	9,100,000	91,000,000	910,000,000
a	0.25	25	25	250	2,500	25,000	250,000	2,500,000	25,000,000	250,000,000
b	0.35	35	35	350	3,500	35,000	350,000	3,500,000	35,000,000	350,000,000
d	0.4	40	40	400	4,000	40,000	400,000	4,000,000	40,000,000	400,000,000
e	0.45	45	45	450	4,500	45,000	450,000	4,500,000	45,000,000	450,000,000
f	0.5	50	50	500	5,000	50,000	500,000	5,000,000	50,000,000	500,000,000
m	0.6	60	60	600	6,000	60,000	600,000	6,000,000	60,000,000	600,000,000
n	0.7	70	70	700	7,000	70,000	700,000	7,000,000	70,000,000	700,000,000
i	0.8	80	80	800	8,000	80,000	800,000	8,000,000	80,000,000	800,000,000
y	0.9	90	90	900	9,000	90,000	900,000	9,000,000	90,000,000	900,000,000

Tape & Reel Packaging Information

KEMET offers multilayer ceramic chip capacitors packaged in 8, 12 and 16 mm tape on 7" and 13" reels in accordance with EIA Standard 481. This packaging system is compatible with all tape-fed automatic pick and place systems. See Table 2 for details on reeling quantities for commercial chips.

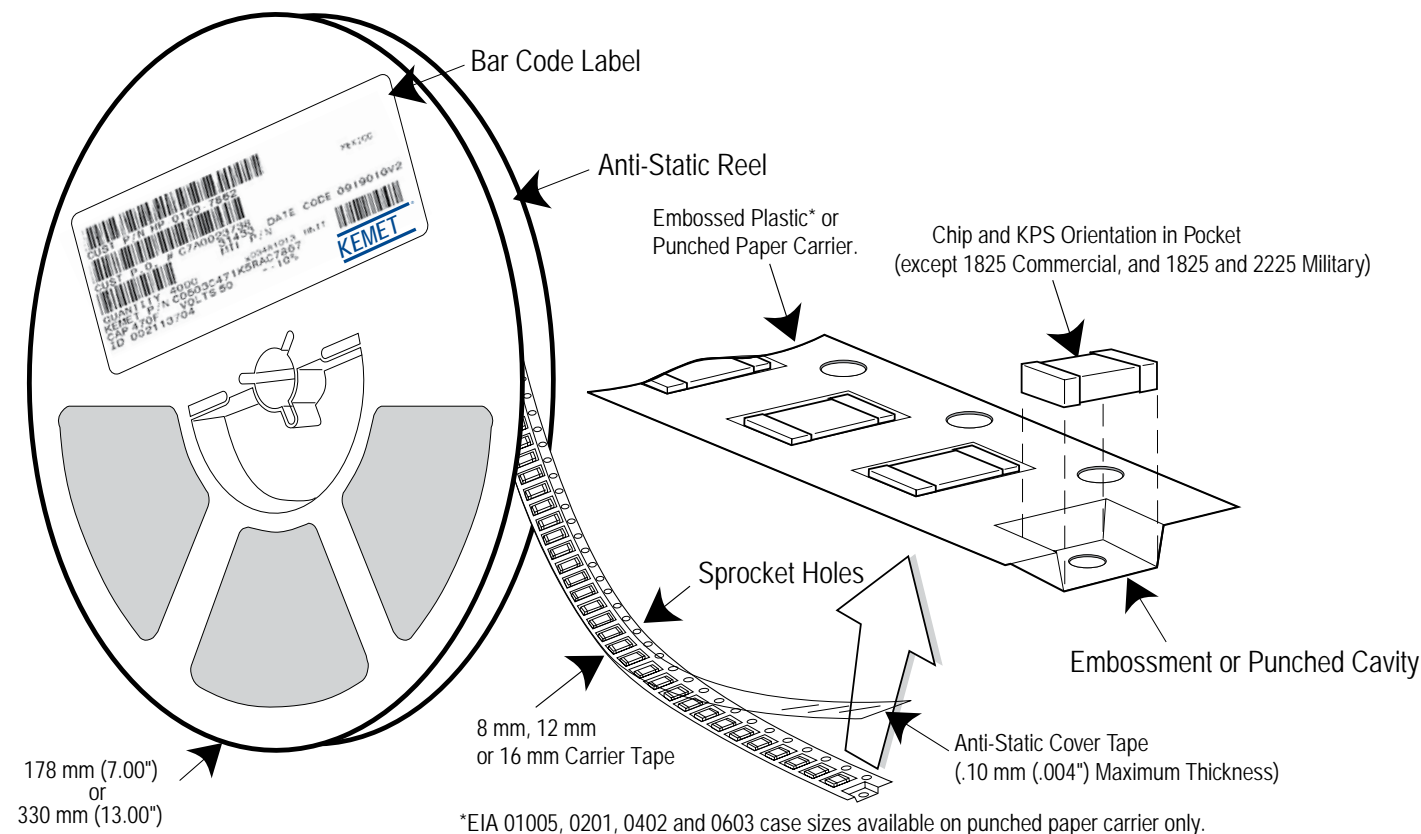

Table 5 – Carrier Tape Configuration – Embossed Plastic & Punched Paper (mm)

EIA Case Size	Tape Size (W)*	Pitch (P ₁)*
01005 – 0402	8	2
0603 – 1210	8	4
1805 – 1808	12	4
≥ 1812	12	8
KPS 1210	12	8
KPS 1812 & 2220	16	12
Array 0508 & 0612	8	4

*Refer to Figures 1 & 2 for W and P₁ carrier tape reference locations.

*Refer to Tables 6 & 7 for tolerance specifications.

Figure 1 – Embossed (Plastic) Carrier Tape Dimensions

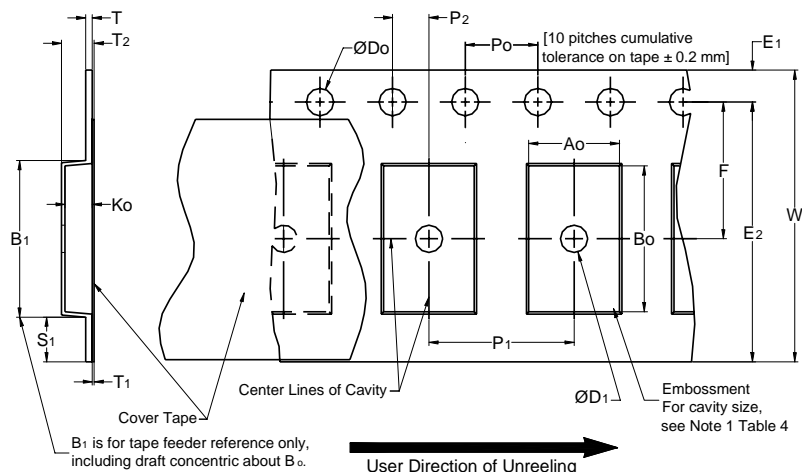

Table 6 – Embossed (Plastic) Carrier Tape Dimensions

Metric will govern

Constant Dimensions — Millimeters (Inches)									
Tape Size	D ₀	D ₁ Minimum Note 1	E ₁	P ₀	P ₂	R Reference Note 2	S ₁ Minimum Note 3	T Maximum	T ₁ Maximum
8 mm	1.5 +0.10/-0.0 (0.059 +0.004/-0.0)	1.0 (0.039)	1.75 ±0.10 (0.069 ±0.004)	4.0 ±0.10 (0.157 ±0.004)	2.0 ±0.05 (0.079 ±0.002)	25.0 (0.984)	0.600 (0.024)	0.600 (0.024)	0.100 (0.004)
12 mm		1.5 (0.059)				30 (1.181)			
16 mm									
Variable Dimensions — Millimeters (Inches)									
Tape Size	Pitch	B ₁ Maximum Note 4	E ₂ Minimum	F	P ₁	T ₂ Maximum	W Maximum	A ₀ , B ₀ & K ₀	
8 mm	Single (4 mm)	4.35 (0.171)	6.25 (0.246)	3.5 ±0.05 (0.138 ±0.002)	4.0 ±0.10 (0.157 ±0.004)	2.5 (0.098)	8.3 (0.327)	Note 5	
12 mm	Single (4 mm) & Double (8 mm)	8.2 (0.323)	10.25 (0.404)	5.5 ±0.05 (0.217 ±0.002)	8.0 ±0.10 (0.315 ±0.004)	4.6 (0.181)	12.3 (0.484)		
16 mm	Triple (12 mm)	12.1 (0.476)	14.25 (0.561)	7.5 ±0.05 (0.138 ±0.002)	12.0 ±0.10 (0.157 ±0.004)	4.6 (0.181)	16.3 (0.642)		

- The embossment hole location shall be measured from the sprocket hole controlling the location of the embossment. Dimensions of embossment location and hole location shall be applied independent of each other.
- The tape with or without components shall pass around R without damage (see Figure 6).
- If S₁ < 1.0 mm, there may not be enough area for cover tape to be properly applied (see EIA Standard 481 paragraph 4.3 section b).
- B₁ dimension is a reference dimension for tape feeder clearance only.
- The cavity defined by A₀, B₀ and K₀ shall surround the component with sufficient clearance that:
 - the component does not protrude above the top surface of the carrier tape.
 - the component can be removed from the cavity in a vertical direction without mechanical restriction, after the top cover tape has been removed.
 - rotation of the component is limited to 20° maximum for 8 and 12 mm tapes and 10° maximum for 16 mm tapes (see Figure 3).
 - lateral movement of the component is restricted to 0.5 mm maximum for 8 and 12 mm wide tape and to 1.0 mm maximum for 16 mm tape (see Figure 4).
 - for KPS Series product, A₀ and B₀ are measured on a plane 0.3 mm above the bottom of the pocket.
 - see Addendum in EIA Standard 481 for standards relating to more precise taping requirements.

Figure 2 – Punched (Paper) Carrier Tape Dimensions

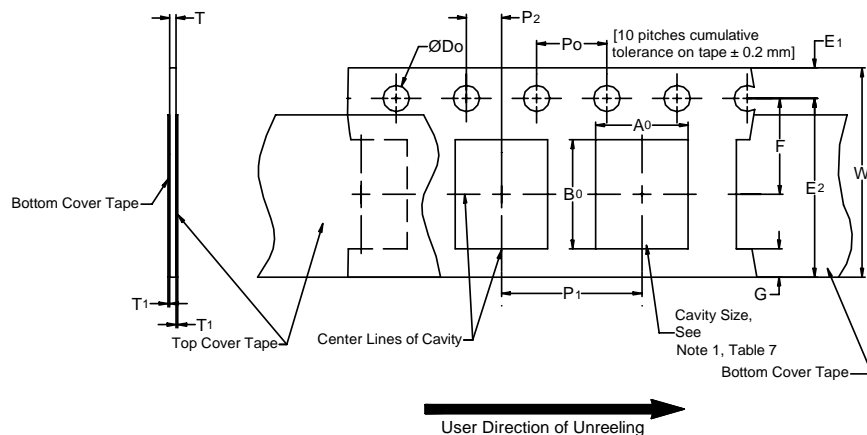

Table 7 – Punched (Paper) Carrier Tape Dimensions

Metric will govern

Constant Dimensions — Millimeters (Inches)							
Tape Size	D_0	E_1	P_0	P_2	T_1 Maximum	G Minimum	R Reference Note 2
8 mm	$1.5 +0.10 -0.0$ (0.059 +0.004 -0.0)	1.75 ± 0.10 (0.069 ±0.004)	4.0 ± 0.10 (0.157 ±0.004)	2.0 ± 0.05 (0.079 ±0.002)	0.10 (0.004) Maximum	0.75 (0.030)	25 (0.984)
Variable Dimensions — Millimeters (Inches)							
Tape Size	Pitch	E2 Minimum	F	P_1	T Maximum	W Maximum	$A_0 B_0$
8 mm	Half (2 mm)	6.25 (0.246)	3.5 ± 0.05 (0.138 ±0.002)	2.0 ± 0.05 (0.079 ±0.002)	1.1 (0.098)	8.3 (0.327)	Note 1
8 mm	Single (4 mm)			4.0 ± 0.10 (0.157 ±0.004)			

- The cavity defined by A_0 , B_0 and T shall surround the component with sufficient clearance that:
 - the component does not protrude beyond either surface of the carrier tape.
 - the component can be removed from the cavity in a vertical direction without mechanical restriction, after the top cover tape has been removed.
 - rotation of the component is limited to 20° maximum (see Figure 3).
 - lateral movement of the component is restricted to 0.5 mm maximum (see Figure 4).
 - see Addendum in EIA Standard 481 for standards relating to more precise taping requirements.
- The tape with or without components shall pass around R without damage (see Figure 6).

Packaging Information Performance Notes

- 1. Cover Tape Break Force:** 1.0 Kg minimum.
- 2. Cover Tape Peel Strength:** The total peel strength of the cover tape from the carrier tape shall be:

Tape Width	Peel Strength
8 mm	0.1 to 1.0 Newton (10 to 100 gf)
12 and 16 mm	0.1 to 1.3 Newton (10 to 130 gf)

The direction of the pull shall be opposite the direction of the carrier tape travel. The pull angle of the carrier tape shall be 165° to 180° from the plane of the carrier tape. During peeling, the carrier and/or cover tape shall be pulled at a velocity of 300 ±10 mm/minute.

- 3. Labeling:** Bar code labeling (standard or custom) shall be on the side of the reel opposite the sprocket holes. Refer to EIA Standards 556 and 624.

Figure 3 – Maximum Component Rotation

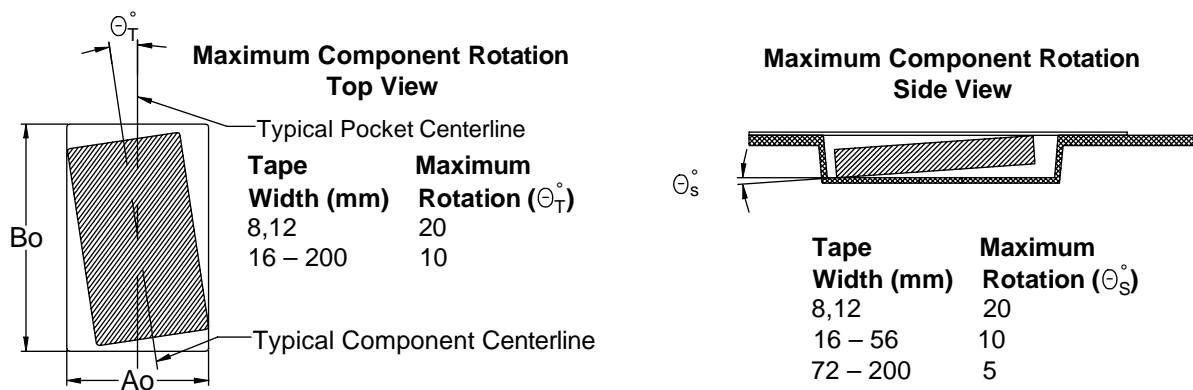

Figure 4 – Maximum Lateral Movement

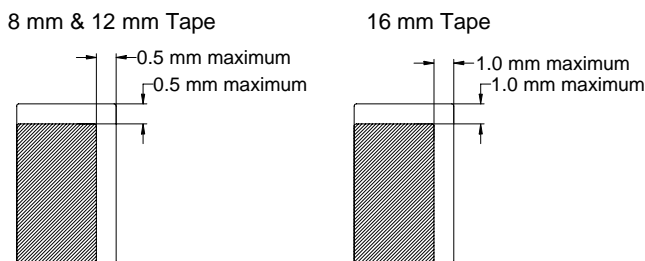

Figure 5 – Bending Radius

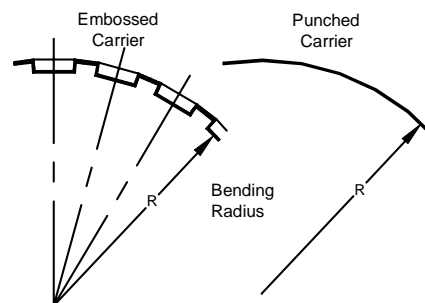
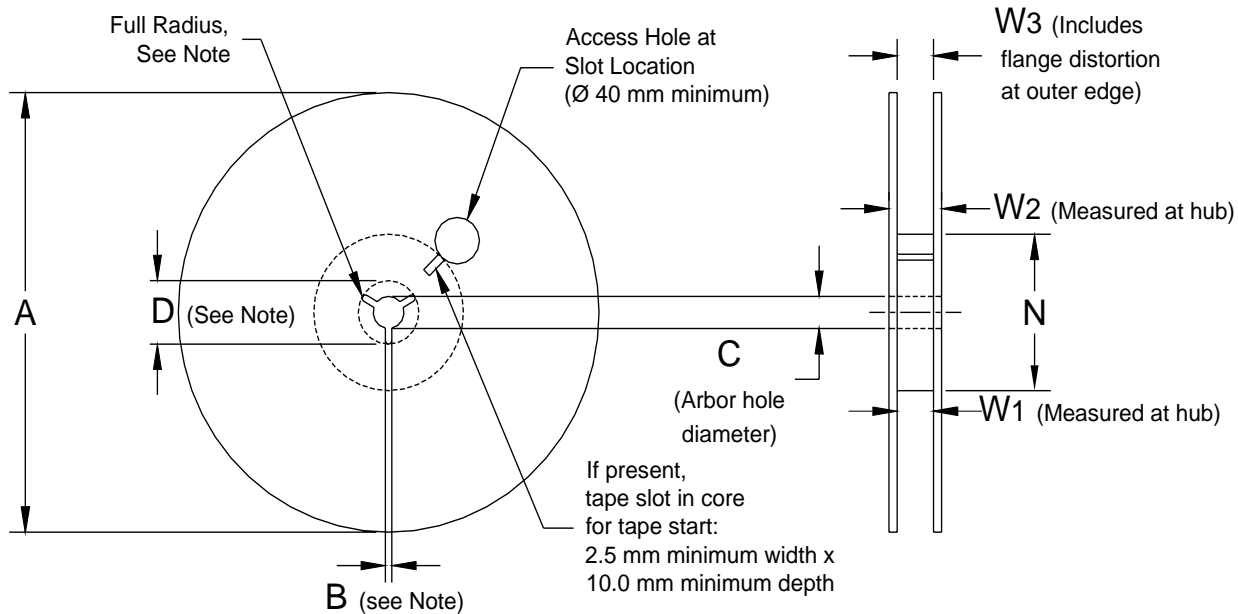

Figure 6 – Reel Dimensions



Note: Drive spokes optional; if used, dimensions B and D shall apply.

Table 8 – Reel Dimensions

Metric will govern

Constant Dimensions — Millimeters (Inches)				
Tape Size	A	B Minimum	C	D Minimum
8 mm	178 ±0.20 (7.008 ±0.008) or 330 ±0.20 (13.000 ±0.008)	1.5 (0.059)	13.0 +0.5/-0.2 (0.521 +0.02/-0.008)	20.2 (0.795)
12 mm				
16 mm				
Variable Dimensions — Millimeters (Inches)				
Tape Size	N Minimum	W ₁	W ₂ Maximum	W ₃
8 mm	50 (1.969)	8.4 +1.5/-0.0 (0.331 +0.059/-0.0)	14.4 (0.567)	Shall accommodate tape width without interference
12 mm		12.4 +2.0/-0.0 (0.488 +0.078/-0.0)	18.4 (0.724)	
16 mm		16.4 +2.0/-0.0 (0.646 +0.078/-0.0)	22.4 (0.882)	

Figure 7 – Tape Leader & Trailer Dimensions

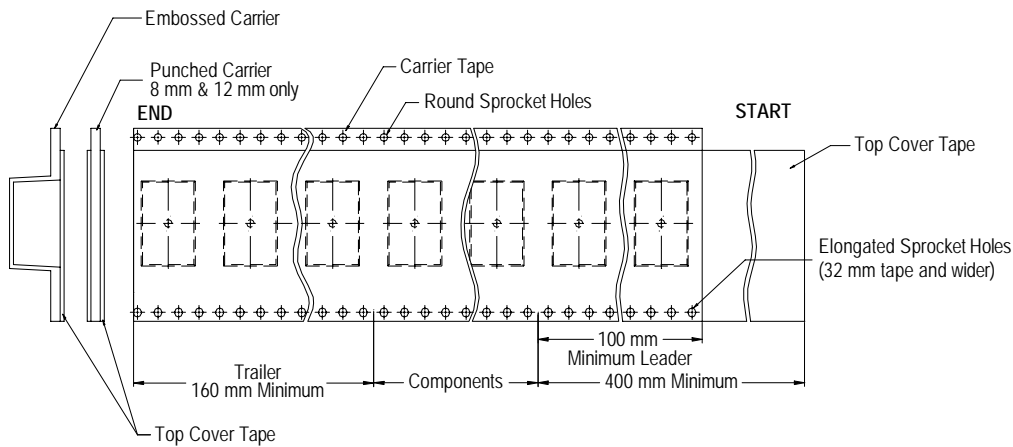
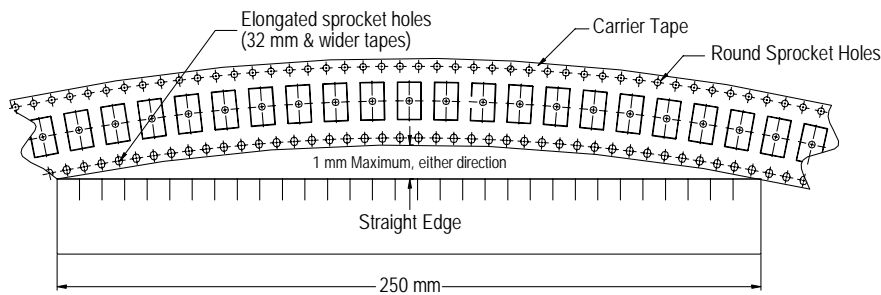

Figure 8 – Maximum Camber



KEMET Corporation World Headquarters

2835 KEMET Way
Simpsonville, SC 29681

Mailing Address:
P.O. Box 5928
Greenville, SC 29606

www.kemet.com
Tel: 864-963-6300
Fax: 864-963-6521

Corporate Offices
Fort Lauderdale, FL
Tel: 954-766-2800

North America

Southeast
Lake Mary, FL
Tel: 407-855-8886

Northeast
Wilmington, MA
Tel: 978-658-1663

Central
Novi, MI
Tel: 248-994-1030

West
Milpitas, CA
Tel: 408-433-9950

Mexico
Guadalajara, Jalisco
Tel: 52-33-3123-2141

Europe

Southern Europe
Paris, France
Tel: 33-1-4646-1006

Sasso Marconi, Italy
Tel: 39-051-939111

Central Europe
Landsberg, Germany
Tel: 49-8191-3350800

Kamen, Germany
Tel: 49-2307-438110

Northern Europe
Bishop's Stortford, United Kingdom
Tel: 44-1279-460122

Espoo, Finland
Tel: 358-9-5406-5000

Asia

Northeast Asia
Hong Kong
Tel: 852-2305-1168

Shenzhen, China
Tel: 86-755-2518-1306

Beijing, China
Tel: 86-10-5829-1711

Shanghai, China
Tel: 86-21-6447-0707

Taipei, Taiwan
Tel: 886-2-27528585

Southeast Asia
Singapore
Tel: 65-6586-1900

Penang, Malaysia
Tel: 60-4-6430200

Bangalore, India
Tel: 91-806-53-76817

Note: KEMET reserves the right to modify minor details of internal and external construction at any time in the interest of product improvement. KEMET does not assume any responsibility for infringement that might result from the use of KEMET Capacitors in potential circuit designs. KEMET is a registered trademark of KEMET Electronics Corporation.

Other KEMET Resources

Tools	
Resource	Location
Configure A Part: CapEdge	http://capacitoredge.kemet.com
SPICE & FIT Software	http://www.kemet.com/spice
Search Our FAQs: KnowledgeEdge	http://www.kemet.com/keask
Electrolytic LifeCalculator	http://www.kemet.com:8080/elc

Product Information	
Resource	Location
Products	http://www.kemet.com/products
Technical Resources (Including Soldering Techniques)	http://www.kemet.com/technicalpapers
RoHS Statement	http://www.kemet.com/rohs
Quality Documents	http://www.kemet.com/qualitydocuments

Product Request	
Resource	Location
Sample Request	http://www.kemet.com/sample
Engineering Kit Request	http://www.kemet.com/kits

Contact	
Resource	Location
Website	www.kemet.com
Contact Us	http://www.kemet.com/contact
Investor Relations	http://www.kemet.com/ir
Call Us	1-877-MyKEMET
Twitter	http://twitter.com/kemetcapacitors

Disclaimer

All product specifications, statements, information and data (collectively, the "Information") are subject to change without notice.

All Information given herein is believed to be accurate and reliable, but is presented without guarantee, warranty, or responsibility of any kind, expressed or implied.

Statements of suitability for certain applications are based on our knowledge of typical operating conditions for such applications, but are not intended to constitute – and we specifically disclaim – any warranty concerning suitability for a specific customer application or use. This Information is intended for use only by customers who have the requisite experience and capability to determine the correct products for their application. Any technical advice inferred from this Information or otherwise provided by us with reference to the use of our products is given gratis, and we assume no obligation or liability for the advice given or results obtained.

Although we design and manufacture our products to the most stringent quality and safety standards, given the current state of the art, isolated component failures may still occur. Accordingly, customer applications which require a high degree of reliability or safety should employ suitable designs or other safeguards (such as installation of protective circuitry or redundancies) in order to ensure that the failure of an electrical component does not result in a risk of personal injury or property damage.

Although all product-related warnings, cautions and notes must be observed, the customer should not assume that all safety measures are indicated or that other measures may not be required.

