

# T216 Series Axial MIL-PRF-39003 (CSS13 Style) and T256 (CSS33 Style)

## Overview

T216 and T256 are KEMET's designation for MIL Style CSS13 and CSS33 capacitors. The T216/T256 Series is qualified to all failure rates per MIL-PRF-39003/10. Products meeting this specification have passed rigorous test requirements and are used in space applications or

other equally demanding environments. These capacitors provide circuit designers with an excellent choice for blocking, bypass, decoupling, filtering, and timing applications.

## Benefits

- Taped and reeled per EIA Specification RS-296
- Marking per MIL-STD-1285
- Qualified to MIL-PRF-39003 (CSS13 and CSS33 Style)
- Failure rate options: Graded – B, C
- The T216 is available in capacitance ratings from 0.12  $\mu\text{F}$  to 330  $\mu\text{F}$  and voltage rating from 6 – 75 VDC
- The T256 is available in capacitance ratings from 1.2  $\mu\text{F}$  to 1,000  $\mu\text{F}$  and voltage rating from 6 – 50 VDC
- Tolerances of  $\pm 10\%$
- Operating temperature range of  $-55^{\circ}\text{C}$  to  $+125^{\circ}\text{C}$
- Case sizes: A, B, C, D



## Applications

These capacitors provide circuit designers an excellent choice for blocking, bypass, decoupling, filtering, and timing applications.

## Ordering Information – T216/T256

T	216	A	106	K	050	C	S	
Capacitor Class	Series	Case Size	Capacitance Code (pF)	Capacitance Tolerance	Rated Voltage (VDC)	Failure Rate	Termination Finish	C-Spec
T = Tantalum	216 (MIL-C-39003/10, CSS13)  256 (MIL-C-39003/10, CSS33)	A B C D	First two digits represent significant figures. Third digit specifies number of zeros.	K = ±10%	006 = 6 010 = 10 015 = 15 020 = 20 035 = 35 050 = 50 075 = 75	Graded: B = 0.1%/k hours C = 0.01%/k hours	S = Standard (Solder-coated nickel)	Blank = Sleeved 0100 = Unsleeved 7200 = Tape & Reel 7200 = Tape & Reel 7293 & 7443 = Ammo

## Ordering Information – T216 (CSS13 Style)

MIL product

M39003	/10	2049	S
Capacitor Class	Slash	Dash Number	Sleeve
Military Specification Number	Specification Sheet Number	Failure Rate Level	S = Sleeved U = Unsleeved use C - 0100

## Ordering Information – T256 (CSS33 Style)

MIL product

M39003	/10	2549	S
Capacitor Class	Slash	Dash Number	Sleeve
Military Specification Number	Specification Sheet Number	Failure Rate Level	S = Sleeved U = Unsleeved use C - 0100

## Performance Characteristics

Item	Performance Characteristics
Operating Temperature	-55°C to 125°C
Rated Capacitance Range	CSS13 = 0.12 µF – 330 µF at 120 Hz/25°C CSS33 = 1.2 µF – 1000 µF at 120 Hz/25°C
Capacitance Tolerance	K Tolerance (10%)
Rated Voltage Range	CSS13 = 6 – 75 V CSS33 = 6 – 50 V
DF (120 Hz at 25°C)	Refer to Part Number Electrical Specification Table
ESR and Impedance (100 kHz at 25°C)	Refer to Part Number Electrical Specification Table
Leakage Current	Refer to Part Number Electrical Specification Table (at rated voltage up to +125°C)
Failure Rate (MIL-PRF-39003, CSS13 & CSS33 capacitors only)	Approved failure rate: C (0.01%/k hours) – Graded

## Dimensions – Inches (Millimeters)

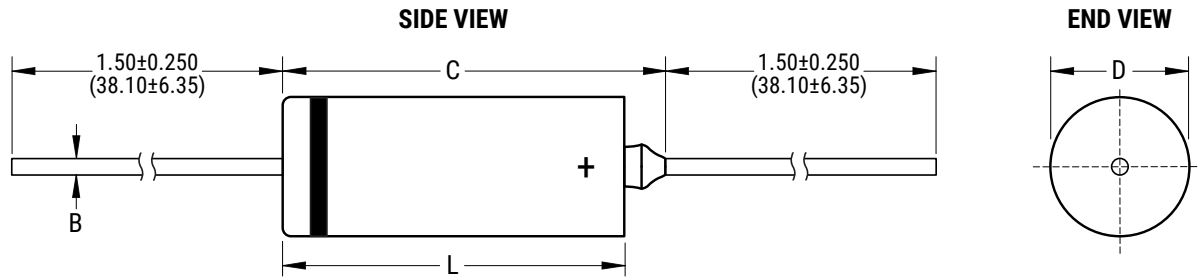

Case Size	Uninsulated		Insulated		B $\pm 0.002$ $\pm(0.05)$	C Maximum
	D	L	D	L		
	$\pm 0.005$ $\pm(0.13)$	$\pm 0.031$ $\pm(0.79)$	$\pm 0.010$ $\pm(0.25)$	$\pm 0.031$ $\pm(0.79)$		
A	0.125 (3.18)	0.250 (6.35)	0.135 (3.43)	0.286 (7.26)	0.020 (0.51)	0.422 (10.72)
B	0.175 (4.45)	0.438 (11.13)	0.185 (4.70)	0.474 (12.04)	0.020 (0.51)	0.610 (15.49)
C	0.279 (7.09)	0.650 (16.51)	0.289 (7.34)	0.686 (17.42)	0.025 (0.64)	0.822 (20.88)
D	0.341 (8.66)	0.750 (19.05)	0.351 (8.92)	0.786 (19.96)	0.025 (0.64)	0.922 (23.42)

**Table 1A – T216 Ratings & Part Number Reference**

Rated Voltage	Rated Capacitance	Case Size Code	DC Leakage	DF % at 25°C	ESR	MIL-PRF-39003 (CSS13 Style)		
						Dash Number Reference		KEMET Equivalent Military
						Failure Rate Level (%/1,000 Hours)		
						MIL-PRF-39003/10		
						Graded		
VDC	µF		µA at 25°C Maximum/5 Minutes	120 Hz Maximum	Q at 25°C 100 kHz Max	B (0.1)	C (0.01)	Part Number
6	5.6	A	0.3	4	0.90	2001(1)	3001(1)	T216A565K006(2)S
6	6.8	A	0.3	6	0.80	2002(1)	3002(1)	T216A685K006(2)S
6	47.0	B	1.5	6	0.24	2003(1)	3003(1)	T216B476K006(2)S
6	56.0	B	1.5	6	0.24	2004(1)	3004(1)	T216B566K006(2)S
6	150.0	C	4.5	8	0.09	2005(1)	3005(1)	T216C157K006(2)S
6	180.0	C	5.5	8	0.08	2006(1)	3006(1)	T216C187K006(2)S
6	270.0	D	6.5	8	0.07	2007(1)	3007(1)	T216D277K006(2)S
6	330.0	D	7.5	8	0.06	2008(1)	3008(1)	T216D337K006(2)S
10	3.9	A	0.3	4	1.00	2009(1)	3009(1)	T216A395K010(2)S
10	4.7	A	0.4	4	0.90	2010(1)	3010(1)	T216A475K010(2)S
10	27.0	B	2.0	6	0.25	2011(1)	3011(1)	T216B276K010(2)S
10	33.0	B	2.5	6	0.24	2012(1)	3012(1)	T216B336K010(2)S
10	39.0	B	2.5	6	0.24	2013(1)	3013(1)	T216B396K010(2)S
10	82.0	C	4.0	6	0.12	2014(1)	3014(1)	T216C826K010(2)S
10	100.0	C	5.0	8	0.11	2015(1)	3015(1)	T216C107K010(2)S
10	120.0	C	6.0	8	0.10	2016(1)	3016(1)	T216C127K010(2)S
10	180.0	D	9.0	8	0.08	2017(1)	3017(1)	T216D187K010(2)S
10	220.0	D	10.0	8	0.07	2018(1)	3018(1)	T216D227K010(2)S
15	2.7	A	0.3	4	1.20	2019(1)	3019(1)	T216A275K015(2)S
15	3.3	A	0.4	4	1.00	2020(1)	3020(1)	T216A335K015(2)S
15	18.0	B	2.0	6	0.27	2021(1)	3021(1)	T216B186K015(2)S
15	22.0	B	2.0	6	0.26	2022(1)	3022(1)	T216B226K015(2)S
15	56.0	C	4.0	6	0.15	2023(1)	3023(1)	T216C566K015(2)S
15	68.0	C	5.0	6	0.13	2024(1)	3024(1)	T216C686K015(2)S
15	120.0	D	9.0	8	0.09	2025(1)	3025(1)	T216D127K015(2)S
15	150.0	D	10.0	8	0.09	2026(1)	3026(1)	T216D157K015(2)S
20	1.2	A	0.3	4	1.40	2027(1)	3027(1)	T216A125K020(2)S
20	1.5	A	0.3	4	1.30	2028(1)	3028(1)	T216A155K020(2)S
20	1.8	A	0.3	4	1.25	2029(1)	3029(1)	T216A185K020(2)S
20	2.2	A	0.4	4	1.20	2030(1)	3030(1)	T216A225K020(2)S
20	8.2	B	1.0	6	0.39	2031(1)	3031(1)	T216B825K020(2)S
20	10.0	B	1.5	6	0.35	2032(1)	3032(1)	T216B106K020(2)S
20	12.0	B	1.8	6	0.32	2033(1)	3033(1)	T216B126K020(2)S
20	15.0	B	2.0	6	0.29	2034(1)	3034(1)	T216B156K020(2)S
20	27.0	C	2.5	6	0.21	2035(1)	3035(1)	T216C276K020(2)S
20	33.0	C	3.5	6	0.19	2036(1)	3036(1)	T216C336K020(2)S
20	39.0	C	4.0	6	0.17	2037(1)	3037(1)	T216C396K020(2)S
20	47.0	C	4.5	6	0.16	2038(1)	3038(1)	T216C476K020(2)S
20	56.0	D	5.5	6	0.13	2039(1)	3039(1)	T216D566K020(2)S
20	68.0	D	7.0	6	0.12	2040(1)	3040(1)	T216D686K020(2)S
20	82.0	D	8.0	6	0.11	2041(1)	3041(1)	T216D826K020(2)S
20	100.0	D	10.0	8	0.10	2042(1)	3042(1)	T216D107K020(2)S
35	5.6	B	1.3	4	0.47	2043(1)	3043(1)	T216B565K035(2)S
35	6.8	B	1.5	6	0.43	2044(1)	3044(1)	T216B685K035(2)S
35	22.0	C	4.0	6	0.25	2045(1)	3045(1)	T216C226K035(2)S
35	27.0	D	4.5	6	0.18	2046(1)	3046(1)	T216D276K035(2)S
35	33.0	D	5.5	6	0.17	2047(1)	3047(1)	T216D336K035(2)S
35	39.0	D	7.0	6	0.15	2048(1)	3048(1)	T216D396K035(2)S
VDC	µF	Case Size Code	µA at 25°C Maximum/5 Minutes	120 Hz Maximum	Q at 25°C 100 kHz Max	B (0.1)	C (0.01)	Part Number
Rated Voltage	Rated Capacitance	Case Size Code	DC Leakage	DF % at 25°C	ESR	MIL-PRF-39003 (CSS13 Style)		

(1) To complete MIL-PRF-39003 dash part number, insert S for sleeved or U for unsleeved. If "U" ordered also use C0100.  
 (2) To complete KEMET Part Number (T216, T256), insert Graded failure rate - B for .1%/k hours, C for .01%/k hours. Designates reliability level.

**Table 1A – T216 Ratings & Part Number Reference cont'd**

Rated Voltage	Rated Capacitance	Case Size Code	DC Leakage	DF % at 25°C	ESR	MIL-PRF-39003 (CSS13 Style)		
						Dash Number Reference		KEMET Equivalent Military
						Failure Rate Level (%/1,000 Hours)		
						MIL-PRF-39003/10		
						Graded		
VDC	µF		µA at 25°C Maximum/5 Minutes	120 Hz Maximum	Q at 25°C 100 kHz Max	B (0.1)	C (0.01)	Part Number
35	47.0	D	8.0	6	0.14	2049(1)	3049(1)	T216D476K035(2)S
50	0.12	A	0.3	4	6.50	2067(1)	3067(1)	T216A124K050(2)S
50	0.15	A	0.3	4	5.50	2068(1)	3068(1)	T216A154K050(2)S
50	0.18	A	0.3	4	5.00	2069(1)	3069(1)	T216A184K050(2)S
50	0.22	A	0.3	4	4.00	2070(1)	3070(1)	T216A224K050(2)S
50	0.27	A	0.3	4	3.50	2071(1)	3071(1)	T216A274K050(2)S
50	0.33	A	0.3	4	3.30	2072(1)	3072(1)	T216A334K050(2)S
50	0.39	A	0.3	4	3.20	2073(1)	3073(1)	T216A394K050(2)S
50	0.47	A	0.3	4	3.00	2074(1)	3074(1)	T216A474K050(2)S
50	0.56	A	0.3	4	2.50	2075(1)	3075(1)	T216A564K050(2)S
50	0.68	A	0.3	4	1.80	2076(1)	3076(1)	T216A684K050(2)S
50	0.82	A	0.3	4	1.60	2077(1)	3077(1)	T216A824K050(2)S
50	1.0	A	0.4	4	1.40	2078(1)	3078(1)	T216A105K050(2)S
50	1.2	B	0.4	4	1.20	2079(1)	3079(1)	T216B125K050(2)S
50	1.5	B	0.6	4	1.10	2080(1)	3080(1)	T216B155K050(2)S
50	1.8	B	0.7	4	0.92	2081(1)	3081(1)	T216B185K050(2)S
50	2.2	B	0.8	4	0.80	2082(1)	3082(1)	T216B225K050(2)S
50	2.7	B	1.0	4	0.68	2083(1)	3083(1)	T216B275K050(2)S
50	3.3	B	1.2	4	0.62	2084(1)	3084(1)	T216B335K050(2)S
50	3.9	B	1.5	4	0.56	2085(1)	3085(1)	T216B395K050(2)S
50	4.7	B	1.7	4	0.51	2086(1)	3086(1)	T216B475K050(2)S
50	5.6	C	2.2	4	0.44	2087(1)	3087(1)	T216C565K050(2)S
50	6.8	C	2.2	6	0.40	2088(1)	3088(1)	T216C685K050(2)S
50	8.2	C	2.5	6	0.36	2089(1)	3089(1)	T216C825K050(2)S
50	10.0	C	2.5	6	0.33	2090(1)	3090(1)	T216C106K050(2)S
50	12.0	C	3.0	6	0.30	2091(1)	3091(1)	T216C126K050(2)S
50	15.0	C	4.0	6	0.27	2092(1)	3092(1)	T216C156K050(2)S
50	18.0	C	4.5	6	0.25	2093(1)	3093(1)	T216C186K050(2)S
50	22.0	D	5.5	6	0.20	2094(1)	3094(1)	T216D226K050(2)S
75	0.15	A	0.3	4	4.4	2097(1)	3097(1)	T216A154K075(2)S
75	0.18	A	0.3	4	4.0	2098(1)	3098(1)	T216A184K075(2)S
75	0.22	A	0.3	4	3.5	2099(1)	3099(1)	T216A224K075(2)S
75	0.27	A	0.3	4	3.1	2100(1)	3100(1)	T216A274K075(2)S
75	0.33	A	0.3	4	2.8	2101(1)	3101(1)	T216A334K075(2)S
75	0.39	A	0.3	4	2.6	2102(1)	3102(1)	T216A394K075(2)S
75	0.47	A	0.3	4	2.4	2103(1)	3103(1)	T216A474K075(2)S
75	0.56	A	0.3	4	2.25	2104(1)	3104(1)	T216A564K075(2)S
75	0.68	A	0.3	4	2.10	2105(1)	3105(1)	T216A684K075(2)S
75	0.82	B	0.3	4	1.47	2106(1)	3106(1)	T216B824K075(2)S
75	1.0	B	0.4	4	1.40	2107(1)	3107(1)	T216B105K075(2)S
75	1.2	B	0.4	4	1.33	2108(1)	3108(1)	T216B125K075(2)S
75	1.5	B	0.6	4	1.06	2109(1)	3109(1)	T216B155K075(2)S
75	1.8	B	0.7	4	0.92	2110(1)	3110(1)	T216B185K075(2)S
75	2.2	B	0.8	4	0.80	2111(1)	3111(1)	T216B225K075(2)S
75	2.7	B	1.0	4	0.68	2112(1)	3112(1)	T216B275K075(2)S
75	3.3	B	1.2	4	0.62	2113(1)	3113(1)	T216B335K075(2)S
75	3.9	B	1.5	4	0.56	2114(1)	3114(1)	T216B395K075(2)S
75	4.7	C	3.0	4	0.47	2115(1)	3115(1)	T216C475K075(2)S
VDC	µF	Case Size Code	µA at 25°C Maximum/5 Minutes	120 Hz Maximum	Q at 25°C 100 kHz Max	B (0.1)	C (0.01)	Part Number
Rated Voltage	Rated Capacitance		DC Leakage	DF % at 25°C	ESR	MIL-PRF-39003 (CSS13 Style)		

(1) To complete MIL-PRF-39003 dash part number, insert S for sleeved or U for unsleeved. If "U" ordered also use C0100.  
(2) To complete KEMET Part Number (T216, T256), insert Graded failure rate - B for .1%/k hours, C for .01%/k hours. Designates reliability level.

**Table 1A – T216 Ratings & Part Number Reference cont'd**

Rated Voltage	Rated Capacitance	Case Size Code	DC Leakage	DF % at 25°C	ESR	MIL-PRF-39003 (CSS13 Style)		
						Dash Number Reference		KEMET Equivalent Military
						Failure Rate Level (%/1,000 Hours)		
						MIL-PRF-39003/10		
						Graded		
VDC	µF		µA at 25°C Maximum/5 Minutes	120 Hz Maximum	Ω at 25°C 100 kHz Max	B (0.1)	C (0.01)	Part Number
75	5.6	C	3.0	4	0.44	2116(1)	3116(1)	T216C565K075(2)S
75	6.8	C	5.0	6	0.44	2117(1)	3117(1)	T216C685K075(2)S
75	8.2	C	5.0	6	0.36	2118(1)	3118(1)	T216C825K075(2)S
75	10.0	C	5.0	6	0.33	2119(1)	3119(1)	T216C106K075(2)S
75	12.0	D	5.0	6	0.26	2120(1)	3120(1)	T216D126K075(2)S
75	15.0	D	7.0	6	0.23	2121(1)	3121(1)	T216D156K075(2)S
VDC	µF	Case Size Code	µA at 25°C Maximum/5 Minutes	120 Hz Maximum	Ω at 25°C 100 kHz Max	B (0.1)	C (0.01)	Part Number
Rated Voltage	Rated Capacitance	Case Size Code	DC Leakage	DF % at 25°C	ESR	MIL-PRF-39003 (CSS13 Style)		

**Table 1B – T256 Ratings & Part Number Reference**

Rated Voltage	Rated Capacitance	Case Size Code	DC Leakage	DF % at 25°C	ESR	MIL-PRF-39003 (CSS33 Style)		
						Dash Number Reference		KEMET Equivalent Military
						Failure Rate Level (%/1,000 Hours)		
						MIL-PRF-39003/10		
						Graded		
VDC	µF		µA at 25°C Maximum/5 Minutes	120 Hz Maximum	Ω at 25°C 100 kHz Max	B (0.1)	C (0.01)	Part Number
6	10.0	A	0.5	6	0.70	2500(1)	3500(1)	T256A106K006(2)S
6	12.0	A	0.5	6	0.60	2501(1)	3501(1)	T256A126K006(2)S
6	100.0	B	1.0	8	0.20	2502(1)	3502(1)	T256B107K006(2)S
6	330.0	C	2.0	8	0.065	2503(1)	3503(1)	T256B107K006(2)S
6	390.0	C	2.0	10	0.065	2504(1)	3504(1)	T256C337K006(2)S
6	470.0	C	2.0	10	0.060	2505(1)	3505(1)	T256C397K006(2)S
6	680.0	D	5.0	10	0.060	2506(1)	3506(1)	T256D687K006(2)S
6	820.0	D	5.0	10	0.055	2507(1)	3507(1)	T256D827K006(2)S
6	1000.0	D	5.0	10	0.050	2508(1)	3508(1)	T256D108K006(2)S
10	6.8	A	0.5	6	0.80	2509(1)	3509(1)	T256A685K010(2)S
10	8.2	A	0.5	6	0.70	2510(1)	3510(1)	T256A825K010(2)S
10	47.0	B	1.0	6	0.22	2511(1)	3511(1)	T256B476K010(2)S
10	56.0	B	1.0	6	0.20	2512(1)	3512(1)	T256B566K010(2)S
10	68.0	B	1.0	6	0.18	2513(1)	3513(1)	T256B686K010(2)S
10	82.0	B	1.0	6	0.15	2514(1)	3514(1)	T256B826K010(2)S
10	220.0	C	1.0	2	0.090	2515(1)	3515(1)	T256C227K010(2)S
VDC	µF	Case Size Code	µA at 25°C Maximum/5 Minutes	120 Hz Maximum	Ω at 25°C 100 kHz Max	B (0.1)	C (0.01)	Part Number
Rated Voltage	Rated Capacitance	Case Size Code	DC Leakage	DF % at 25°C	ESR	MIL-PRF-39003 (CSS33 Style)		

(1) To complete MIL-PRF-39003 dash part number, insert S for sleeved or U for unsleeved. If "U" ordered also use C0100.

(2) To complete KEMET Part Number (T216, T256), insert Graded failure rate - B for .1%/k hours, C for .01%/k hours. Designates reliability level.

**Table 1B – T256 Ratings & Part Number Reference cont'd**

Rated Voltage	Rated Capacitance	Case Size Code	DC Leakage	DF % at 25°C	ESR	MIL-PRF-39003 (CSS33 Style)		
						Dash Number Reference		KEMET Equivalent Military
						Failure Rate Level (%/1,000 Hours)		
						MIL-PRF-39003/10		
						Graded		
VDC	µF		µA at 25°C Maximum/5 Minutes	120 Hz Maximum	Q at 25°C 100 kHz Max	B (0.1)	C (0.01)	Part Number
10	270.0	C	2.0	2	0.075	2516(1)	3516(1)	T256C277K010(2)S
10	390.0	D	2.0	10	0.070	2517(1)	3517(1)	T256D397K010(2)S
10	470.0	D	4.0	10	0.065	2518(1)	3518(1)	T256D477K010(2)S
10	560.0	D	4.0	10	0.060	2519(1)	3519(1)	T256D567K010(2)S
15	4.7	A	0.5	4	0.90	2520(1)	3520(1)	T256A475K015(2)S
15	5.6	A	0.5	4	0.80	2521(1)	3521(1)	T256A565K015(2)S
15	33.0	B	1.0	6	0.24	2522(1)	3522(1)	T256B336K015(2)S
15	39.0	B	1.0	6	0.22	2523(1)	3523(1)	T256B396K015(2)S
15	150.0	C	1.0	8	0.10	2524(1)	3524(1)	T256C157K015(2)S
15	180.0	C	2.0	8	0.09	2525(1)	3525(1)	T256C187K015(2)S
15	220.0	D	2.0	8	0.07	2526(1)	3526(1)	T256D227K015(2)S
15	270.0	D	2.0	8	0.065	2527(1)	3527(1)	T256D277K015(2)S
15	330.0	D	2.0	8	0.060	2528(1)	3528(1)	T256D337K015(2)S
20	2.7	A	0.5	4	1.15	2529(1)	3529(1)	T256A275K020(2)S
20	3.3	A	0.5	4	0.95	2530(1)	3530(1)	T256A335K020(2)S
20	3.9	A	0.5	4	0.90	2531(1)	3531(1)	T256A395K020(2)S
20	18.0	B	1.0	6	0.27	2532(1)	3532(1)	T256B186K020(2)S
20	22.0	B	1.0	6	0.26	2533(1)	3533(1)	T256B226K020(2)S
20	27.0	B	1.0	6	0.24	2534(1)	3534(1)	T256B276K020(2)S
20	56.0	C	1.0	6	0.15	2535(1)	3535(1)	T256C566K020(2)S
20	68.0	C	1.0	6	0.14	2536(1)	3536(1)	T256C686K020(2)S
20	82.0	C	1.0	6	0.12	2537(1)	3537(1)	T256C826K020(2)S
20	100.0	C	1.0	6	0.10	2538(1)	3538(1)	T256C107K020(2)S
20	120.0	C	1.0	6	0.09	2539(1)	3539(1)	T256C127K020(2)S
20	150.0	D	2.0	8	0.08	2540(1)	3540(1)	T256D157K020(2)S
20	180.0	D	2.0	8	0.07	2541(1)	3541(1)	T256D187K020(2)S
35	1.8	A	0.5	4	0.20	2542(1)	3542(1)	T256A185K035(2)S
35	8.2	B	1.0	6	0.40	2543(1)	3543(1)	T256B825K035(2)S
35	10.0	B	1.0	6	0.35	2544(1)	3544(1)	T256B106K035(2)S
35	33.0	C	1.0	6	0.19	2545(1)	3545(1)	T256C336K035(2)S
35	39.0	C	1.0	6	0.17	2546(1)	3546(1)	T256C396K035(2)S
35	47.0	C	1.0	6	0.15	2547(1)	3547(1)	T256C476K035(2)S
35	56.0	D	2.0	6	0.13	2548(1)	3548(1)	T256D566K035(2)S
35	68.0	D	2.0	6	0.12	2549(1)	3549(1)	T256D686K035(2)S
50	1.2	A	0.5	4	1.30	2550(1)	3550(1)	T256A125K050(2)S
50	1.5	A	0.5	4	1.20	2551(1)	3551(1)	T256A155K050(2)S
50	5.6	B	1.0	4	0.47	2552(1)	3552(1)	T256B565K050(2)S
50	6.8	B	1.0	6	0.43	2553(1)	3553(1)	T256B685K050(2)S
50	22.0	C	1.0	6	0.22	2554(1)	3554(1)	T256C226K050(2)S
50	27.0	C	1.0	6	0.20	2555(1)	3555(1)	T256C276K050(2)S
50	33.0	D	1.0	6	0.18	2556(1)	3556(1)	T256D336K050(2)S
50	39.0	D	1.0	6	0.16	2557(1)	3557(1)	T256D396K050(2)S
VDC	µF	Case Size Code	µA at 25°C Maximum/5 Minutes	120 Hz Maximum	Q at 25°C 100 kHz Max	B (0.1)	C (0.01)	Part Number
Rated Voltage	Rated Capacitance	Case Size Code	DC Leakage	DF % at 25°C	ESR	MIL-PRF-39003 (CSS33 Style)		

(1) To complete MIL-PRF-39003 dash part number, insert S for sleeved or U for unsleeved. If "U" ordered also use C0100.

(2) To complete KEMET Part Number (T216, T256), insert Graded failure rate - B for .1%/k hours, C for .01%/k hours. Designates reliability level.

## Ripple Current/Ripple Voltage

Permissible AC ripple voltage is related to the ESR of the capacitor and the power dissipation capabilities of a particular case size.

Thermal capacities for the various case sizes have been determined empirically and are listed below.

Temperature Compensation Multipliers for Maximum Power Dissipation		
T ≤ 25°C	T ≤ 85°C	T ≤ 125°C
1.00	0.90	0.40

*T = Environmental Temperature*

Permissible AC ripple current can be determined by the following:

$$I(max) = Z \sqrt{P_{max}/R}$$

*P max = maximum watts*

*R = ESR at specified frequency (ohms)*

*I = rms ripple current (amperes)*

*Z = capacitor impedance in ohms at the specified frequency*

Case Size	Maximum Power Dissipation (P max)	T2XX
A	0.09	0.070
B	0.100	0.090
C	0.125	–
D	0.180	–

*Maximum Power Dissipation: 25°C Ambient*



## Optimum Solder Wave Profile

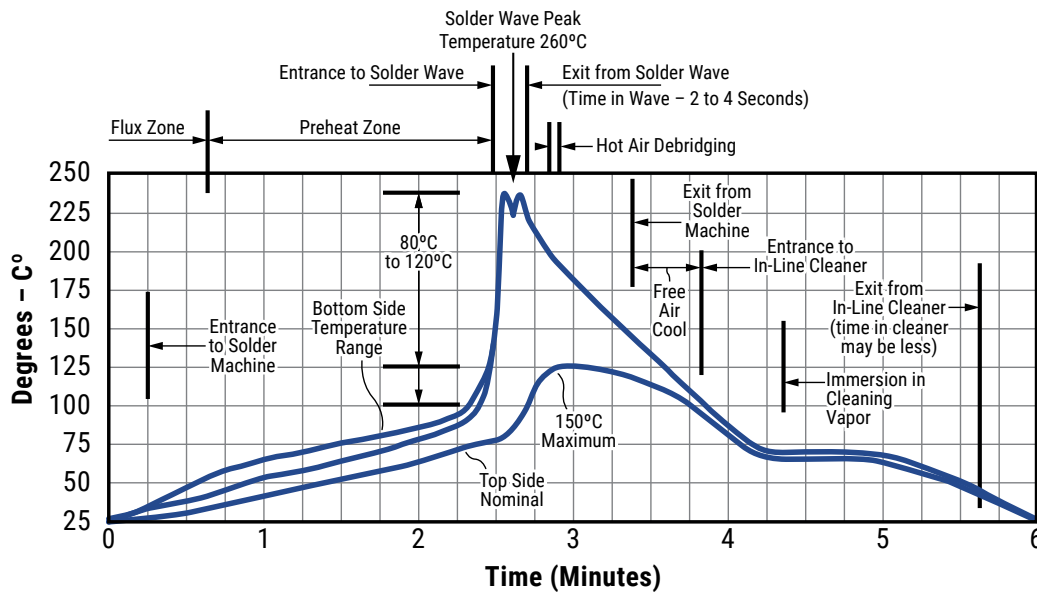

## Mounting

All encased capacitors will pass the Resistance to Soldering Heat Test of MIL-STD-202, Method 210, Condition C. This test simulates wave solder of topside board mount product. This demonstration of resistance to solder heat is in accordance with what is believed to be the industry standard. More severe treatment must be considered reflective of an improper soldering process. The above figure is a recommended solder wave profile for both axial and radial leaded solid tantalum capacitors.

## Construction

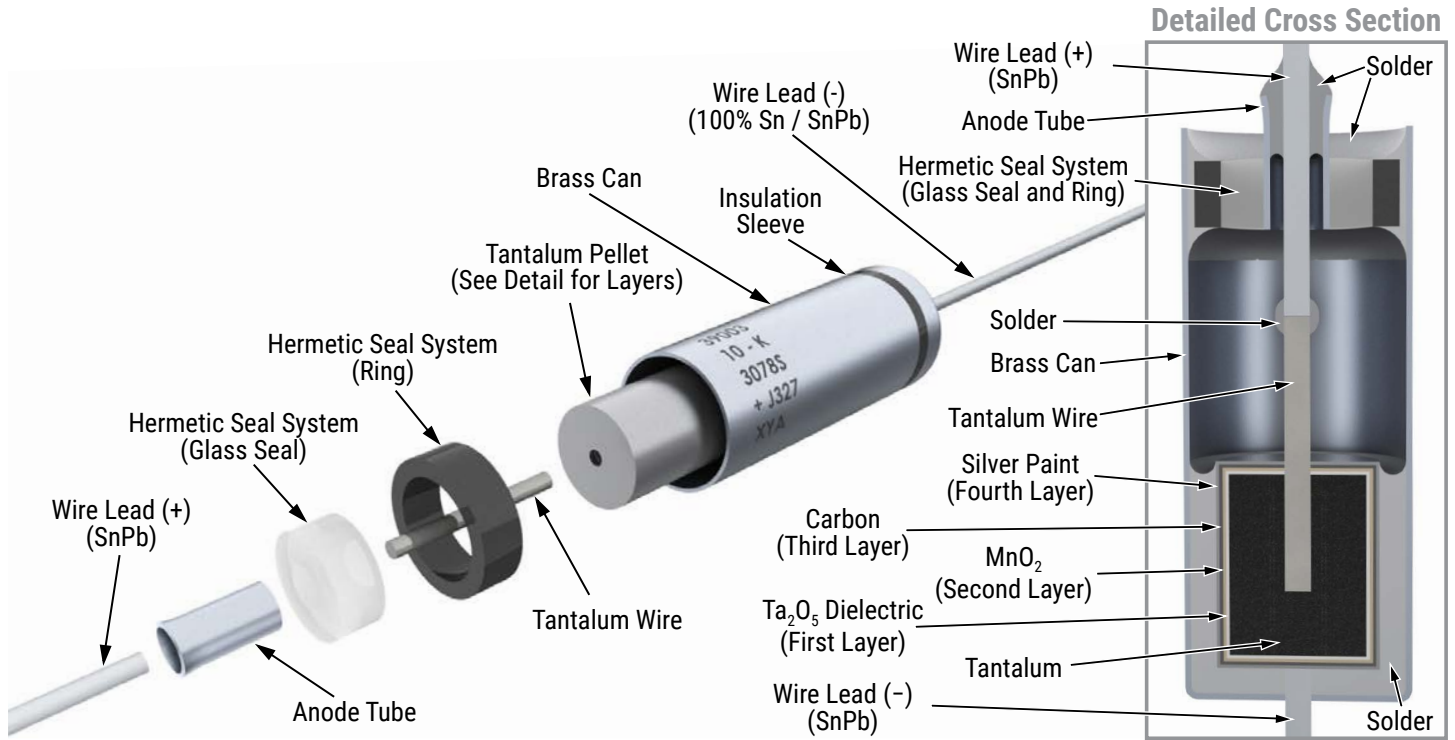

## Capacitor Marking

### A Case

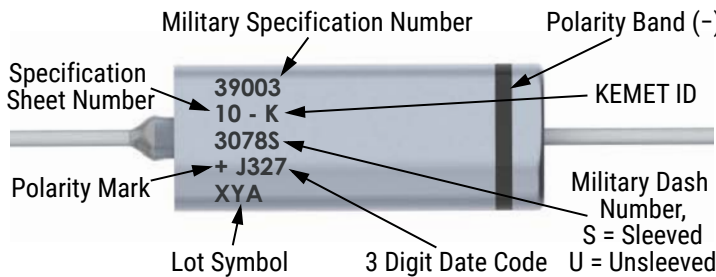

### B Case

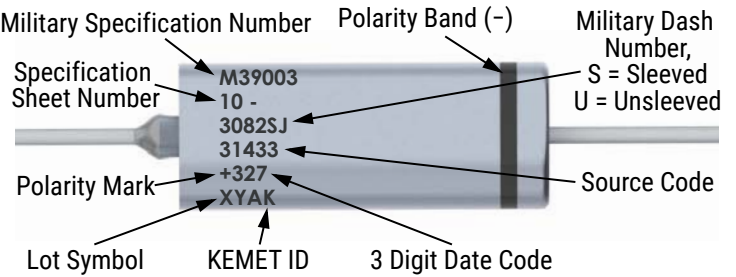

Date Code	3 Digit	4 Digit
Year	5 = 2015 6 = 2016 7 = 2017 8 = 2018 9 = 2019	15 = 2015 16 = 2016 17 = 2017 18 = 2018 19 = 2019
Week	01 = 1 <sup>st</sup> week of the year to 52 = 52 <sup>nd</sup> week of the year	

### C & D Case

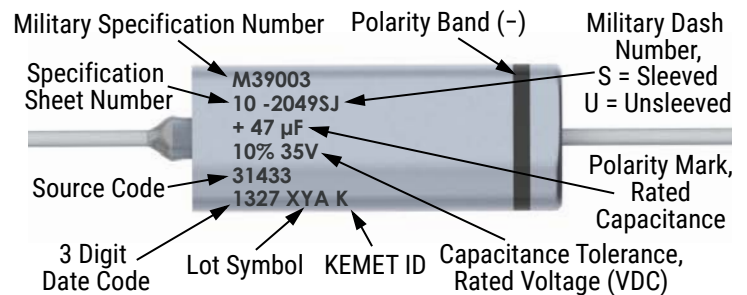

## Storage

Tantalum hermetically sealed capacitors should be stored in normal working environments. While the capacitors themselves are quite robust in other environments, solderability will be degraded by exposure to high temperatures, high humidity, corrosive atmospheres, and long term storage. In addition, packaging materials will be degraded by high temperature – reels may soften or warp and tape peel force may increase. KEMET recommends that maximum storage temperature not exceed 40°C and maximum storage humidity not exceed 60% relative humidity. Temperature fluctuations should be minimized to avoid condensation on the parts and atmospheres should be free of chlorine and sulphur bearing compounds. For optimized solderability capacitors stock should be used promptly, preferably within three years of receipt.

## Tape & Reel Packaging Information

KEMET offers standard reeling of Solid Tantalum Capacitors for automatic insertion or lead forming machines per EIA Specification RS-296E.

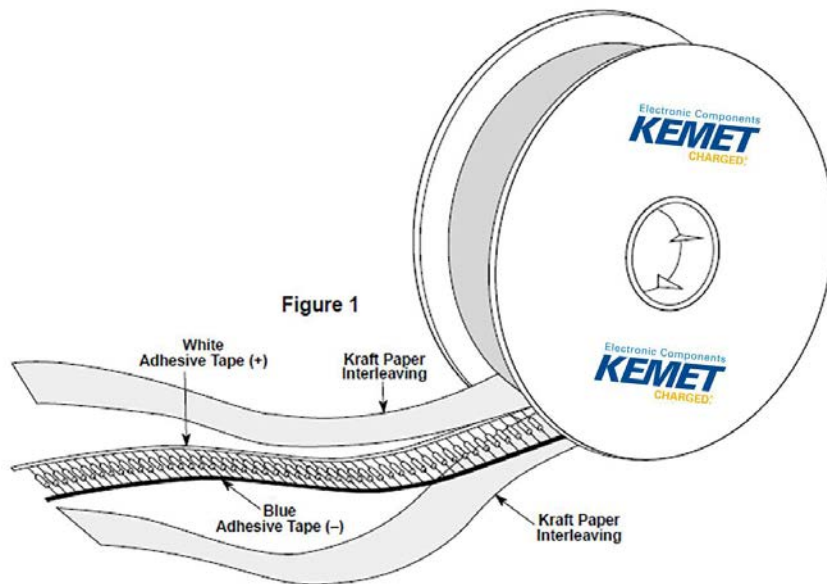

**Table 2 – Packaging Quantity**

Case Size	Standard Bulk Quantity	Standard Reel Quantity	Reel C-Spec
A	40/Tray	3,500	C-7200
B	30/Tray	2,500	C-7200
C	20/Tray	500	C-7200
D	20/Tray	400	C-7200

**Figure 2**

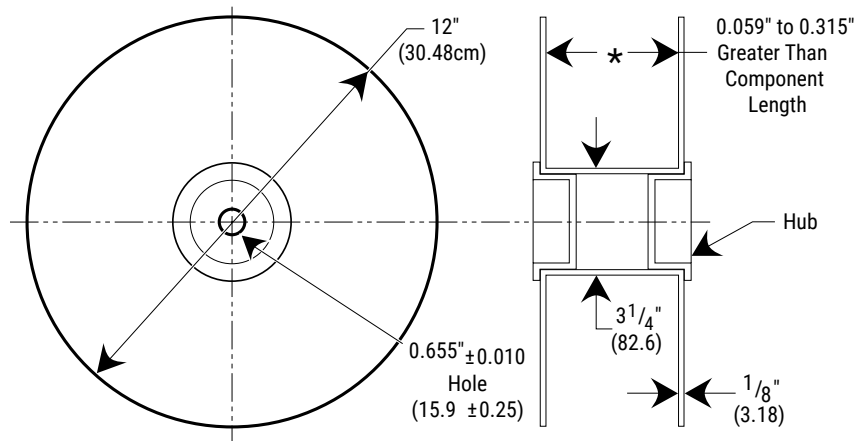

**Figure 3**

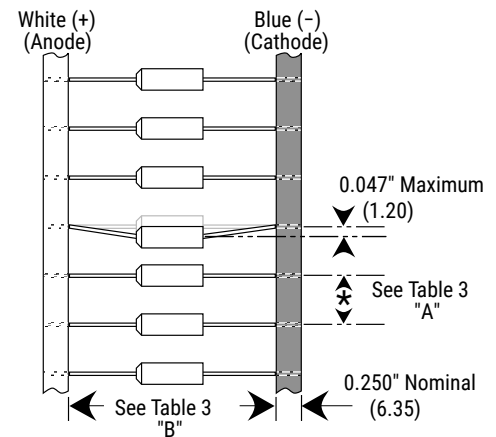

**Table 3 – Tape Dimensions**

Component Body Diameter	Component Pitch "A"	Inside Tape Spacing "B" ±1.5 mm (0.059")		
		I	II	III
0" (0 mm) to 0.197" (5 mm)	0.020" or (±0.5 mm)	2.062"	2.500"	2.874"
0.197" (5.01 mm) to 0.394" (10 mm)	0.400 or (10 mm)	(52.4 mm)	(63.5 mm)	(73 mm)

Capacitors are reeled so that positive leads are oriented as shown in Figure 3. Kraft paper (50lb. test minimum) is inserted between the layers of capacitors wound on reels for component pitch  $\leq 0.200$ " sizes and corrugated paper (70 lb. test minimum), single faced is inserted for component pitch  $\geq 0.400$ " sizes. Capacitor lead length may extend only a maximum of 0.031" (0.8 mm) beyond the tape's edges. Capacitors are centered in a row between the two tapes and will deviate only  $\pm 0.031$ " (0.79 mm) from the row center. Figures 1 and 2 show the KEMET standard chipboard tape reel. A minimum of 36" (91.5 cm) leader tape is provided at each end of the reeled capacitors. Universal splicing clips are used to connect the tape.

## KEMET Electronic Corporation Sales Offices

For a complete list of our global sales offices, please visit [www.kemet.com/sales](http://www.kemet.com/sales).

---

### Disclaimer

All product specifications, statements, information and data (collectively, the "Information") in this datasheet are subject to change. The customer is responsible for checking and verifying the extent to which the Information contained in this publication is applicable to an order at the time the order is placed.

All Information given herein is believed to be accurate and reliable, but it is presented without guarantee, warranty, or responsibility of any kind, expressed or implied.

Statements of suitability for certain applications are based on KEMET Electronics Corporation's ("KEMET") knowledge of typical operating conditions for such applications, but are not intended to constitute – and KEMET specifically disclaims – any warranty concerning suitability for a specific customer application or use. The Information is intended for use only by customers who have the requisite experience and capability to determine the correct products for their application. Any technical advice inferred from this Information or otherwise provided by KEMET with reference to the use of KEMET's products is given gratis, and KEMET assumes no obligation or liability for the advice given or results obtained.

Although KEMET designs and manufactures its products to the most stringent quality and safety standards, given the current state of the art, isolated component failures may still occur. Accordingly, customer applications which require a high degree of reliability or safety should employ suitable designs or other safeguards (such as installation of protective circuitry or redundancies) in order to ensure that the failure of an electrical component does not result in a risk of personal injury or property damage.

Although all product-related warnings, cautions and notes must be observed, the customer should not assume that all safety measures are indicated or that other measures may not be required.

*KEMET is a registered trademark of KEMET Electronics Corporation.*