

T222 Series Axial MIL-PRF-39003 Polar Miniature (CSR09 Style)

Overview

The KEMET ultra-miniature T222 Series solid tantalum capacitors are especially designed for miniaturization and employ a unique glass-to-metal compression end seal which has no protruding eyelet. This flush end seal construction ideally suits the T222 Series for all miniature

high density packaging applications. The capacitors consist of a dry porous tantalum pellet hermetically sealed in a solder coated metal case with solder coated alloy 52 and solder coated nickel. The T222 series is approved to all ratings and failure rates of MIL-PRF-39003/2.

Benefits

- Taped and reeled per EIA Specification RS-296
- Marking per MIL-STD-1285
- Qualified to MIL-PRF-39003 (CSR09 Style)
- Failure rate options: Graded - B, C, D, and G Exponential – M, P, R, and S*
- Capacitance values of 0.047 μ F to 18 μ F
- Tolerances of $\pm 5\%$, and $\pm 10\%$
- Voltage rating of 6 – 75 VDC
- Operating temperature range of -55°C to $+125^{\circ}\text{C}$
- Case sizes: A and B

**Failure rates apply to military products only*



Applications

KEMET ultra-miniature T222 Series solid tantalum capacitors are especially designed for miniaturization.

Ordering Information

| T | 222 | A | 225 | K | 010 | B | S | C |
|-----------------|--------------|-----------|--|-----------------------|---|---|--|--|
| Capacitor Class | Series | Case Size | Capacitance Code (pF) | Capacitance Tolerance | Rated Voltage (VDC) | Failure Rate/Military Product Only | Termination Finish | Specification |
| T = Tantalum | T222 (CSR09) | A B | First two digits represent significant figures. Third digit specifies number of zeros. | J = ±5% K = ±10% | 006 = 6 010 = 10 015 = 15 020 = 20 035 = 35 050 = 50 075 = 75 | Graded: B = 0.1%/k hours C = 0.01%/k hours D = 0.001%/k hours Exponential: G = 1.0%/k hours M = 1%/k hours P = 0.1%/k hours R = 0.01%/k hours S = 0.001%/k hours | S = Standard Positive: Alloy 52 (solder-coated) Negative: Solder-coated nickel | Blank = Bulk/Sleeved 7200 = Tape & Reel 7293 & 7443 = Ammo All capacitors are sleeved unless specified. |

Ordering Information – T222 (CSR09 Style)

MIL product

| M39003 | /02 | 2061 | D |
|-------------------------------|----------------------------|--------------------|---|
| Capacitor Class | Slash | Dash Number | Surge Option |
| Military specification number | Specification sheet number | Failure rate level | D = C-4250 E = C-4251 F = C-4252 H = No C-Spec |

Orders should be entered by the military specification number, including the dash number and surge option letter (D, E, F, or H).

Performance Characteristics

| Item | Performance Characteristics |
|---|--|
| Operating Temperature | -55°C to 125°C |
| Rated Capacitance Range | 0.047 – 18 µF at 120 Hz/25°C |
| Capacitance Tolerance | J Tolerance (5%), K Tolerance (10%) |
| Rated Voltage Range | 6 – 75 V |
| DF (120 Hz at 25°C) | Refer to Part Number Electrical Specification Table |
| ESR and Impedance (100 kHz at 25°C) | Refer to Part Number Electrical Specification Table (for reference only) |
| Leakage Current | Refer to Part Number Electrical Specification Table (at rated voltage up to +85°C and 2/3 of rated voltage applied at 125°C) |
| Failure Rate (MIL-39003, CSR13 capacitors only) | Approved failure rate: S (0.001%/k hours) – Exponential, D (0.001%/k hours) – Graded |

Dimensions – Inches (Millimeters)

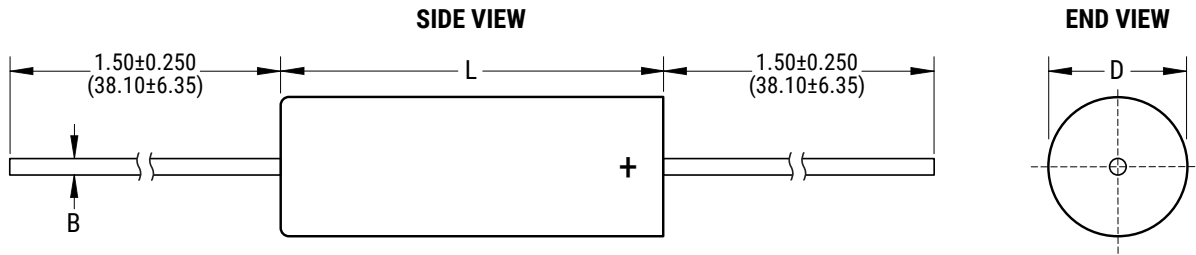

| Case Size | Uninsulated | | Insulated | | B Wire Diameter |
|-----------|---------------------------------|--|----------------------------------|--|--|
| | D ± 0.005 (± 0.13) | L | D | L | |
| A | 0.085 (2.16) | $0.245 + 0.015 / - 0.010$ (6.22+0.38/-0.25) | 0.090 ± 0.009 (2.29±0.23) | $0.250 + 0.031 / - 0.015$ (6.35+0.79/-0.38) | $0.016 + 0.005 / - 0.001$ (0.41+0.13/-0.03) |
| B | 0.127 (3.23) | 0.375 ± 0.015 (9.53±0.38) | 0.138 ± 0.010 (3.51±0.25) | 0.390 ± 0.015 (9.91±0.38) | $0.016 + 0.005 / - 0.001$ (0.41+0.13/-0.03) |

Table 1 – Ratings & Part Number Reference

| Rated Voltage | Rated Cap | Case Size Code | KEMET Part Number | DC Leakage | DF % at 25°C | MIL-PRF-39003 (CSR09) Capacitors | | | | | | | |
|---------------|-----------|----------------|------------------------------|--------------------------|----------------|------------------------------------|---------|----------|-----------|------------------|---------|----------|-----------|
| | | | | | | Dash Number Reference | | | | | | | |
| | | | | | | Failure Rate Level (%/1,000 Hours) | | | | | | | |
| | | | | | | MIL-PRF-39003/2J | | | | MIL-PRF-39003/2J | | | |
| | | | | | | Exponential | | | | Graded | | | |
| (V) 85°C | µF | | (See below for part options) | µA at 25°C Max/5 Minutes | 120 Hz Maximum | M (1.0) | P (0.1) | R (0.01) | S (0.001) | G (1) | B (0.1) | C (0.01) | D (0.001) |
| 6 | 2.7 | A | T222A275J006(1)S | 0.6 | 6 | 1001 | 1061 | 1121 | 1181 | 5001 | 2001 | 3001 | 4001 |
| 6 | 2.7 | A | T222A275K006(1)S | 0.6 | 6 | 0001 | 0061 | 0121 | 0181 | 5002 | 2002 | 3002 | 4002 |
| 6 | 18.0 | B | T222B186J006(1)S | 1.4 | 6 | 1002 | 1062 | 1122 | 1182 | 5003 | 2003 | 3003 | 4003 |
| 6 | 18.0 | B | T222B186K006(1)S | 1.4 | 6 | 0002 | 0062 | 0122 | 0182 | 5004 | 2004 | 3004 | 4004 |
| 10 | 1.8 | A | T222A185J010(1)S | 0.6 | 6 | 1007 | 1067 | 1127 | 1187 | 5005 | 2005 | 3005 | 4005 |
| 10 | 1.8 | A | T222A185K010(1)S | 0.6 | 6 | 0007 | 0067 | 0127 | 0187 | 5006 | 2006 | 3006 | 4006 |
| 10 | 2.2 | A | T222A225J010(1)S | 0.6 | 6 | 1008 | 1068 | 1128 | 1188 | 5007 | 2007 | 3007 | 4007 |
| 10 | 2.2 | A | T222A225K010(1)S | 0.6 | 6 | 0008 | 0068 | 0128 | 0188 | 5008 | 2008 | 3008 | 4008 |
| 10 | 10.0 | B | T222B106J010(1)S | 2.0 | 6 | 1009 | 1069 | 1129 | 1189 | 5009 | 2009 | 3009 | 4009 |
| 10 | 10.0 | B | T222B106K010(1)S | 2.0 | 6 | 0009 | 0069 | 0129 | 0189 | 5010 | 2010 | 3010 | 4010 |
| 10 | 12.0 | B | T222B126J010(1)S | 2.0 | 6 | 1010 | 1070 | 1130 | 1190 | 5011 | 2011 | 3011 | 4011 |
| 10 | 12.0 | B | T222B126K010(1)S | 2.0 | 6 | 0010 | 0070 | 0130 | 0190 | 5012 | 2012 | 3012 | 4012 |
| 10 | 15.0 | B | T222B156J010(1)S | 2.0 | 6 | 1011 | 1071 | 1131 | 1191 | 5013 | 2013 | 3013 | 4013 |
| 10 | 15.0 | B | T222B156K010(1)S | 2.0 | 6 | 0011 | 0071 | 0131 | 0191 | 5014 | 2014 | 3014 | 4014 |
| 15 | 1.0 | A | T222A105J015(1)S | 0.6 | 6 | 1012 | 1072 | 1132 | 1192 | 5015 | 2015 | 3015 | 4015 |
| 15 | 1.0 | A | T222A105K015(1)S | 0.6 | 6 | 0012 | 0072 | 0132 | 0192 | 5016 | 2016 | 3016 | 4016 |
| 15 | 1.2 | A | T222A125J015(1)S | 0.6 | 6 | 1013 | 1073 | 1133 | 1193 | 5017 | 2017 | 3017 | 4017 |
| 15 | 1.2 | A | T222A125K015(1)S | 0.6 | 6 | 0013 | 0073 | 0133 | 0193 | 5018 | 2018 | 3018 | 4018 |
| 15 | 1.5 | A | T222A155J015(1)S | 0.6 | 6 | 1014 | 1074 | 1134 | 1194 | 5019 | 2019 | 3019 | 4019 |
| 15 | 1.5 | A | T222A155K015(1)S | 0.6 | 6 | 0014 | 0074 | 0134 | 0194 | 5020 | 2020 | 3020 | 4020 |
| 15 | 8.2 | B | T222B825J015(1)S | 1.8 | 6 | 1015 | 1075 | 1135 | 1195 | 5021 | 2021 | 3021 | 4021 |
| 15 | 8.2 | B | T222B825K075(1)S | 1.8 | 6 | 0015 | 0075 | 0135 | 0195 | 5022 | 2022 | 3022 | 4022 |
| 20 | 0.56 | A | T222A564J020(1)S | 0.6 | 3 | 1016 | 1076 | 1136 | 1196 | 5023 | 2023 | 3023 | 4023 |
| 20 | 0.56 | A | T222A564K020(1)S | 0.6 | 3 | 0016 | 0076 | 0136 | 0196 | 5024 | 2024 | 3024 | 4024 |
| 20 | 0.68 | A | T222A684J020(1)S | 0.6 | 3 | 1017 | 1077 | 1137 | 1197 | 5025 | 2025 | 3025 | 4025 |
| 20 | 0.68 | A | T222A684K020(1)S | 0.6 | 3 | 0017 | 0077 | 0137 | 0197 | 5026 | 2026 | 3026 | 4026 |
| 20 | 0.82 | A | T222A824J020(1)S | 0.6 | 3 | 1018 | 1078 | 1138 | 1198 | 5027 | 2027 | 3027 | 4027 |
| 20 | 0.82 | A | T222A824K020(1)S | 0.6 | 3 | 0018 | 0078 | 0138 | 0198 | 5028 | 2028 | 3028 | 4028 |
| 20 | 1.0 | A | T222A105J020(1)S | 0.6 | 3 | 1019 | 1079 | 1139 | 1199 | 5029 | 2029 | 3029 | 4029 |
| 20 | 1.0 | A | T222A105K020(1)S | 0.6 | 3 | 0019 | 0079 | 0139 | 0199 | 5030 | 2030 | 3030 | 4030 |
| 20 | 3.3 | B | T222B335J020(1)S | 1.0 | 3 | 1020 | 1080 | 1140 | 1200 | 5031 | 2031 | 3031 | 4031 |
| 20 | 3.3 | B | T222B335K020(1)S | 1.0 | 3 | 0020 | 0080 | 0140 | 0200 | 5032 | 2032 | 3032 | 4032 |
| 20 | 3.9 | B | T222B395J020(1)S | 2.0 | 3 | 1021 | 1081 | 1141 | 1201 | 5033 | 2033 | 3033 | 4033 |
| 20 | 3.9 | B | T222B395K020(1)S | 2.0 | 3 | 0021 | 0081 | 0141 | 0201 | 5034 | 2034 | 3034 | 4034 |
| 20 | 4.7 | B | T222B475J020(1)S | 2.0 | 3 | 1022 | 1082 | 1142 | 1202 | 5035 | 2035 | 3035 | 4035 |
| 20 | 4.7 | B | T222B475K020(1)S | 2.0 | 3 | 0022 | 0082 | 0142 | 0202 | 5036 | 2036 | 3036 | 4036 |
| 20 | 5.6 | B | T222B565J020(1)S | 2.0 | 3 | 1023 | 1083 | 1143 | 1203 | 5037 | 2037 | 3037 | 4037 |
| 20 | 5.6 | B | T222B565K020(1)S | 2.0 | 3 | 0023 | 0083 | 0143 | 0203 | 5038 | 2038 | 3038 | 4038 |
| 20 | 6.8 | B | T222B685J020(1)S | 2.0 | 3 | 1024 | 1084 | 1144 | 1204 | 5039 | 2039 | 3039 | 4039 |
| 20 | 6.8 | B | T222B685K020(1)S | 2.0 | 3 | 0024 | 0084 | 0144 | 0204 | 5040 | 2040 | 3040 | 4040 |
| 35 | 0.33 | A | T222A334J035(1)S | 0.6 | 3 | 1025 | 1085 | 1145 | 1205 | 5041 | 2041 | 3041 | 4041 |
| 35 | 0.33 | A | T222A334K035(1)S | 0.6 | 3 | 0025 | 0085 | 0145 | 0205 | 5042 | 2042 | 3042 | 4042 |
| 35 | 0.39 | A | T222A394J035(1)S | 0.6 | 3 | 1026 | 1086 | 1146 | 1206 | 5043 | 2043 | 3043 | 4043 |
| 35 | 0.39 | A | T222A394K035(1)S | 0.6 | 3 | 0026 | 0086 | 0146 | 0206 | 5044 | 2044 | 3044 | 4044 |
| 35 | 0.47 | A | T222A474J035(1)S | 0.6 | 3 | 1027 | 1087 | 1147 | 1207 | 5045 | 2045 | 3045 | 4045 |
| 35 | 0.47 | A | T222A474K035(1)S | 0.6 | 3 | 0027 | 0087 | 0147 | 0207 | 5046 | 2046 | 3046 | 4046 |
| 35 | 2.2 | B | T222B225J035(1)S | 1.4 | 3 | 1028 | 1088 | 1148 | 1208 | 5047 | 2047 | 3047 | 4047 |
| 35 | 2.2 | B | T222B225K035(1)S | 1.4 | 3 | 0028 | 0088 | 0148 | 0208 | 5048 | 2048 | 3048 | 4048 |
| (V) 85°C | µF | Case Size Code | (See below for part options) | µA at 25°C Max/5 Minutes | 120 Hz Maximum | M (1.0) | P (0.1) | R (0.01) | S (0.001) | G (1) | B (0.1) | C (0.01) | D (0.001) |
| Rated Voltage | Rated Cap | Case Size Code | KEMET Part Number | DC Leakage | DF % at 25°C | MIL-PRF-39003 (CSR09) Capacitors | | | | | | | |

(1) To complete KEMET Part Number (T222), insert Graded failure rate - A for Not Applicable, B for 0.1%/k hours, C for 0.01%/k hours, D for 0.001%/k hours or G for 1%/k hours. Designates Reliability Level.

(2) To complete KEMET Part Number (T222), insert Exponential failure rate - M for 1%/k hours, P for 0.1%/k hours, R for 0.01%/k hours, or S for 0.001%/k hours. Designates reliability level.

Table 1 – Ratings & Part Number Reference cont'd

| Rated Voltage | Rated Cap | Case Size Code | KEMET Part Number | DC Leakage | DF % at 25°C | MIL-PRF-39003 (CSR09) Capacitors | | | | | | | |
|---------------|-----------|----------------|------------------------------|--------------------------|----------------|------------------------------------|---------|----------|-----------|------------------|---------|----------|-----------|
| | | | | | | Dash Number Reference | | | | | | | |
| | | | | | | Failure Rate Level (%/1,000 Hours) | | | | | | | |
| | | | | | | MIL-PRF-39003/2J | | | | MIL-PRF-39003/2J | | | |
| | | | | | | Exponential | | | | Graded | | | |
| (V) 85°C | µF | | (See below for part options) | µA at 25°C Max/5 Minutes | 120 Hz Maximum | M (1.0) | P (0.1) | R (0.01) | S (0.001) | G (1) | B (0.1) | C (0.01) | D (0.001) |
| 35 | 2.7 | B | T222B275J035(1)S | 1.4 | 3 | 1029 | 1089 | 1149 | 1209 | 5049 | 2049 | 3049 | 4049 |
| 35 | 2.7 | B | T222B275K035(1)S | 1.4 | 3 | 0029 | 0089 | 0149 | 0209 | 5050 | 2050 | 3050 | 4050 |
| 50 | 0.22 | A | T222A224J050(1)S | 0.6 | 3 | 1030 | 1090 | 1150 | 1210 | 5051 | 2051 | 3051 | 4051 |
| 50 | 0.22 | A | T222A224K050(1)S | 0.6 | 3 | 0030 | 0090 | 0150 | 0210 | 5052 | 2052 | 3052 | 4052 |
| 50 | 0.27 | A | T222A274J050(1)S | 0.6 | 3 | 1031 | 1091 | 1151 | 1211 | 5053 | 2053 | 3053 | 4053 |
| 50 | 0.27 | A | T222A274K050(1)S | 0.6 | 3 | 0031 | 0091 | 0151 | 0211 | 5054 | 2054 | 3054 | 4054 |
| 50 | 1.5 | B | T222B155J050(1)S | 1.4 | 3 | 1032 | 1092 | 1152 | 1212 | 5055 | 2055 | 3055 | 4055 |
| 50 | 1.5 | B | T222B155K050(1)S | 1.4 | 3 | 0032 | 0092 | 0152 | 0212 | 5056 | 2056 | 3056 | 4056 |
| 50 | 1.8 | B | T222B185J050(1)S | 1.4 | 3 | 1033 | 1093 | 1153 | 1213 | 5057 | 2057 | 3057 | 4057 |
| 50 | 1.8 | B | T222B185K050(1)S | 1.4 | 3 | 0033 | 0093 | 0153 | 0213 | 5058 | 2058 | 3058 | 4058 |
| 75 | 0.047 | A | T222A473J075(1)S | 0.6 | 3 | 1034 | 1094 | 1154 | 1214 | 5059 | 2059 | 3059 | 4059 |
| 75 | 0.047 | A | T222A473K075(1)S | 0.6 | 3 | 0034 | 0094 | 0154 | 0214 | 5060 | 2060 | 3060 | 4060 |
| 75 | 0.056 | A | T222A563J075(1)S | 0.6 | 3 | 1035 | 1095 | 1155 | 1215 | 5061 | 2061 | 3061 | 4061 |
| 75 | 0.056 | A | T222A563K075(1)S | 0.6 | 3 | 0035 | 0095 | 0155 | 0215 | 5062 | 2062 | 3062 | 4062 |
| 75 | 0.068 | A | T222A683J075(1)S | 0.6 | 3 | 1036 | 1096 | 1156 | 1216 | 5063 | 2063 | 3063 | 4063 |
| 75 | 0.068 | A | T222A683K075(1)S | 0.6 | 3 | 0036 | 0096 | 0156 | 0216 | 5064 | 2064 | 3064 | 4064 |
| 75 | 0.082 | A | T222A823J075(1)S | 1.8 | 3 | 1037 | 1097 | 1157 | 1217 | 5065 | 2065 | 3065 | 4065 |
| 75 | 0.082 | A | T222A823K075(1)S | 1.8 | 3 | 0037 | 0097 | 0157 | 0217 | 5066 | 2066 | 3066 | 4066 |
| 75 | 0.10 | A | T222A104J075(1)S | 0.6 | 3 | 1038 | 1098 | 1158 | 1218 | 5067 | 2067 | 3067 | 4067 |
| 75 | 0.10 | A | T222A104K075(1)S | 0.6 | 3 | 0038 | 0098 | 0158 | 0218 | 5068 | 2068 | 3068 | 4068 |
| 75 | 0.12 | A | T222A124J075(1)S | 0.6 | 3 | 1039 | 1099 | 1159 | 1219 | 5069 | 2069 | 3069 | 4069 |
| 75 | 0.12 | A | T222A124K075(1)S | 0.6 | 3 | 0039 | 0099 | 0159 | 0219 | 5070 | 2070 | 3070 | 4070 |
| 75 | 0.15 | A | T222A154J075(1)S | 0.6 | 3 | 1040 | 1100 | 1160 | 1220 | 5071 | 2071 | 3071 | 4071 |
| 75 | 0.15 | A | T222A154K075(1)S | 0.6 | 3 | 0040 | 0100 | 0160 | 0220 | 5072 | 2072 | 3072 | 4072 |
| 75 | 0.18 | A | T222A184J075(1)S | 0.6 | 3 | 1041 | 1101 | 1161 | 1221 | 5073 | 2073 | 3073 | 4073 |
| 75 | 0.18 | A | T222A184K075(1)S | 0.6 | 3 | 0041 | 0101 | 0161 | 0221 | 5074 | 2074 | 3074 | 4074 |
| 75 | 0.22 | B | T222B224J075(1)S | 1.0 | 3 | 1042 | 1102 | 1162 | 1222 | 5075 | 2075 | 3075 | 4075 |
| 75 | 0.22 | B | T222B224K075(1)S | 1.0 | 3 | 0042 | 0102 | 0162 | 0222 | 5076 | 2076 | 3076 | 4076 |
| 75 | 0.27 | B | T222B274J075(1)S | 2.0 | 3 | 1043 | 1103 | 1163 | 1223 | 5077 | 2077 | 3077 | 4077 |
| 75 | 0.27 | B | T222B274K075(1)S | 2.0 | 3 | 0043 | 0103 | 0163 | 0223 | 5078 | 2078 | 3078 | 4078 |
| 75 | 0.33 | B | T222B334J075(1)S | 2.0 | 3 | 1044 | 1104 | 1164 | 1224 | 5079 | 2079 | 3079 | 4079 |
| 75 | 0.33 | B | T222B334K075(1)S | 2.0 | 3 | 0044 | 0104 | 0164 | 0224 | 5080 | 2080 | 3080 | 4080 |
| 75 | 0.39 | B | T222B394J075(1)S | 2.0 | 3 | 1045 | 1105 | 1165 | 1225 | 5081 | 2081 | 3081 | 4081 |
| 75 | 0.39 | B | T222B394K075(1)S | 2.0 | 3 | 0045 | 0105 | 0165 | 0225 | 5082 | 2082 | 3082 | 4082 |
| 75 | 0.47 | B | T222B474J075(1)S | 2.0 | 3 | 1046 | 1106 | 1166 | 1226 | 5083 | 2083 | 3083 | 4083 |
| 75 | 0.47 | B | T222B474K075(1)S | 2.0 | 3 | 0046 | 0106 | 0166 | 0226 | 5084 | 2084 | 3084 | 4084 |
| 75 | 0.56 | B | T222B564J075(1)S | 0.6 | 3 | 1047 | 1107 | 1167 | 1227 | 5085 | 2085 | 3085 | 4085 |
| 75 | 0.56 | B | T222B564K075(1)S | 0.6 | 3 | 0047 | 0107 | 0167 | 0227 | 5086 | 2086 | 3086 | 4086 |
| 75 | 0.68 | B | T222B684J075(1)S | 0.6 | 3 | 1048 | 1108 | 1168 | 1228 | 5087 | 2087 | 3087 | 4087 |
| 75 | 0.68 | B | T222B684K075(1)S | 0.6 | 3 | 0048 | 0108 | 0168 | 0228 | 5088 | 2088 | 3088 | 4088 |
| 75 | 0.82 | B | T222B824J075(1)S | 0.6 | 3 | 1049 | 1109 | 1169 | 1229 | 5089 | 2089 | 3089 | 4089 |
| 75 | 0.82 | B | T222B824K075(1)S | 0.6 | 3 | 0049 | 0109 | 0169 | 0229 | 5090 | 2090 | 3090 | 4090 |
| 75 | 1.0 | B | T222B105J075(1)S | 1.4 | 3 | 1050 | 1110 | 1170 | 1230 | 5091 | 2091 | 3091 | 4091 |
| 75 | 1.0 | B | T222B105K075(1)S | 1.4 | 3 | 0050 | 0110 | 0170 | 0230 | 5092 | 2092 | 3092 | 4092 |
| 75 | 1.2 | B | T222B125J075(1)S | 1.4 | 3 | 1051 | 1111 | 1171 | 1231 | 5093 | 2093 | 3093 | 4093 |
| 75 | 1.2 | B | T222B125K075(1)S | 1.4 | 3 | 0051 | 0111 | 0171 | 0231 | 5094 | 2094 | 3094 | 4094 |
| (V) 85°C | µF | Case Size Code | (See below for part options) | µA at 25°C Max/5 Minutes | 120 Hz Maximum | M (1.0) | P (0.1) | R (0.01) | S (0.001) | G (1) | B (0.1) | C (0.01) | D (0.001) |
| Rated Voltage | Rated Cap | Case Size Code | KEMET Part Number | DC Leakage | DF % at 25°C | MIL-PRF-39003 (CSR09) Capacitors | | | | | | | |

(1) To complete KEMET Part Number (T222), insert Graded failure rate - A for Not Applicable, B for 0.1%/k hours, C for 0.01%/k hours, D for 0.001%/k hours or G for 1%/k hours. Designates Reliability Level.

(2) To complete KEMET Part Number (T222), insert Exponential failure rate - M for 1%/k hours, P for 0.1%/k hours, R for 0.01%/k hours, or S for 0.001%/k hours. Designates reliability level.

Ripple Current/Ripple Voltage

Permissible AC ripple voltage is related to the ESR of the capacitor and the power dissipation capabilities of a particular case size.

Thermal capacities for the various case sizes have been determined empirically and are listed below.

| Temperature Compensation Multipliers for Maximum Power Dissipation | | |
|---|----------|-----------|
| T ≤ 25°C | T ≤ 85°C | T ≤ 125°C |
| 1.00 | 0.90 | 0.40 |

T = Environmental Temperature

Permissible AC ripple current can be determined by the following:

$$I(max) = Z \sqrt{P_{max}/R}$$

P max = maximum watts

R = ESR at specified frequency (ohms)

I = rms ripple current (amperes)

Z = capacitor impedance in ohms at the specified frequency

| Case Size | Maximum Power Dissipation (P max) | T2XX |
|-----------|-----------------------------------|-------|
| A | 0.09 | 0.070 |
| B | 0.100 | 0.090 |
| C | 0.125 | – |
| D | 0.180 | – |

Maximum Power Dissipation: 25°C Ambient

Optimum Solder Wave Profile

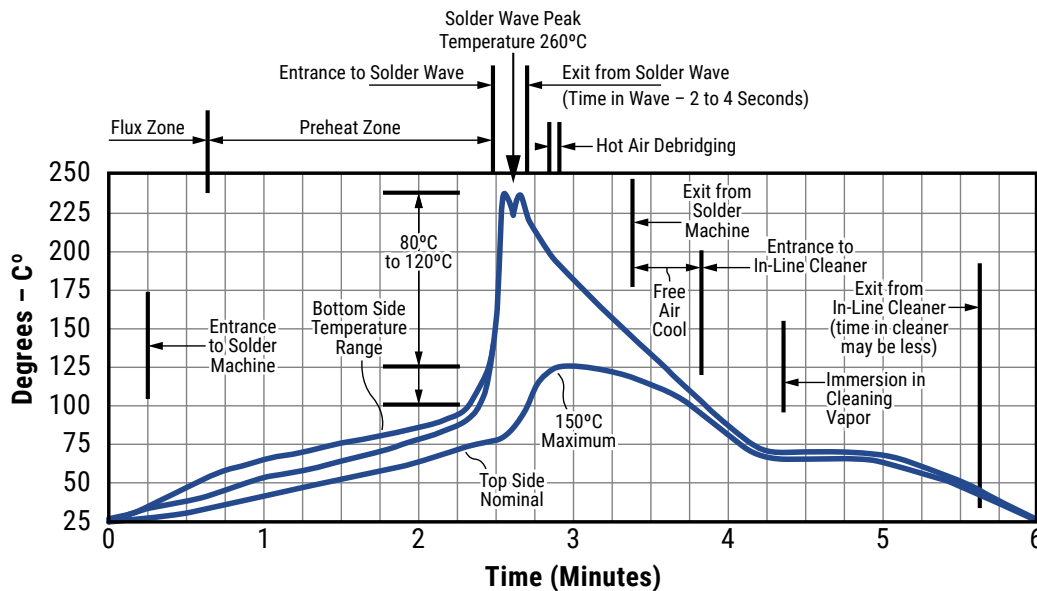

Reverse Voltage

Although these are polar capacitors, some degree of transient voltage reversal is permissible, as seen below. The capacitors should not be operated continuously in reverse mode, even within these limits.

| Temperature | Percentage of Rated Voltage |
|-------------|-----------------------------|
| +25°C | 15 |
| +85°C | 5 |
| +125°C | 1 |

Mounting

All encased capacitors will pass the Resistance to Soldering Heat Test of MIL-STD-202, Method 210, Condition C. This test simulates wave solder of topside board mount product. This demonstration of resistance to solder heat is in accordance with what is believed to be the industry standard. More severe treatment must be considered reflective of an improper soldering process. The above figure is a recommended solder wave profile for both axial and radial leaded solid tantalum capacitors.

Construction

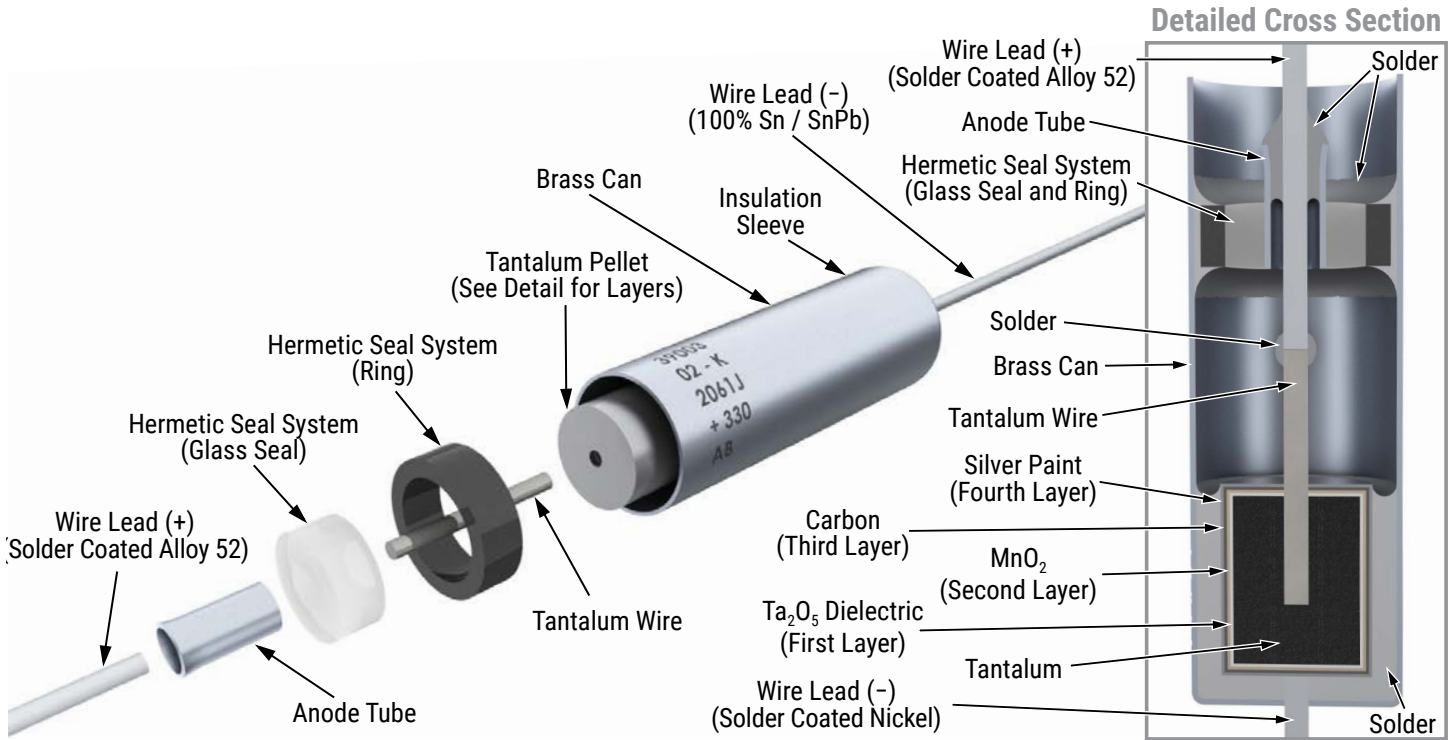

Capacitor Marking

A & B Case

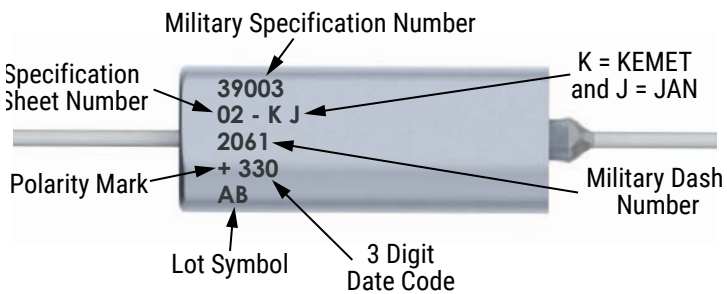

| Date Code | 3 Digit | 4 Digit |
|-----------|--|-----------|
| Year | 5 = 2015 | 15 = 2015 |
| | 6 = 2016 | 16 = 2016 |
| | 7 = 2017 | 17 = 2017 |
| | 8 = 2018 | 18 = 2018 |
| | 9 = 2019 | 19 = 2019 |
| Week | 01 = 1 st week of the year to 52 = 52 nd week of the year | |

Storage

Tantalum hermetically sealed capacitors should be stored in normal working environments. While the capacitors themselves are quite robust in other environments, solderability will be degraded by exposure to high temperatures, high humidity, corrosive atmospheres, and long term storage. In addition, packaging materials will be degraded by high temperature – reels may soften or warp and tape peel force may increase. KEMET recommends that maximum storage temperature not exceed 40°C and maximum storage humidity not exceed 60% relative humidity. Temperature fluctuations should be minimized to avoid condensation on the parts and atmospheres should be free of chlorine and sulphur bearing compounds. For optimized solderability capacitors stock should be used promptly, preferably within three years of receipt.

Tape & Reel Packaging Information

KEMET offers standard reeling of Solid Tantalum Capacitors for automatic insertion or lead forming machines per EIA Specification RS-296E.

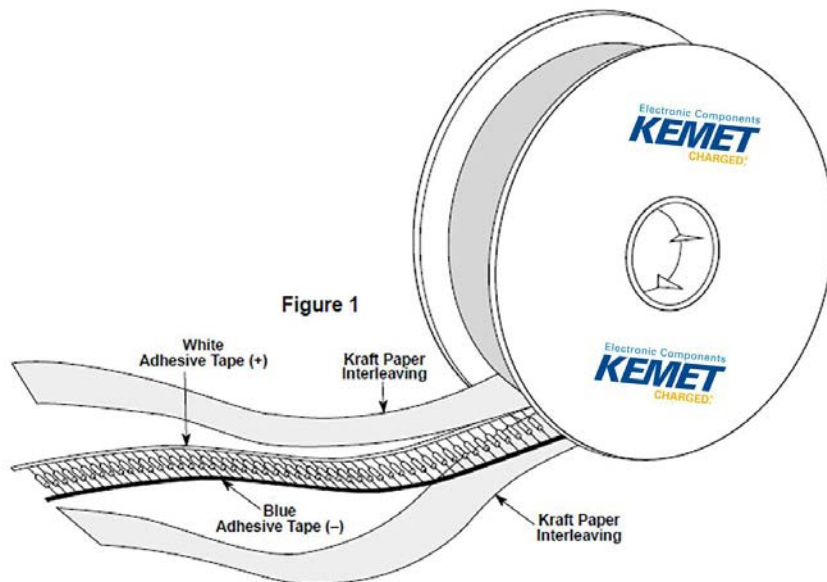

Table 2 – Packaging Quantity

| Case Size | Standard Bulk Quantity |
|-----------|------------------------|
| A/B | 50/Tray |
| A | 300/Box |
| B | 150/Box |

Figure 2

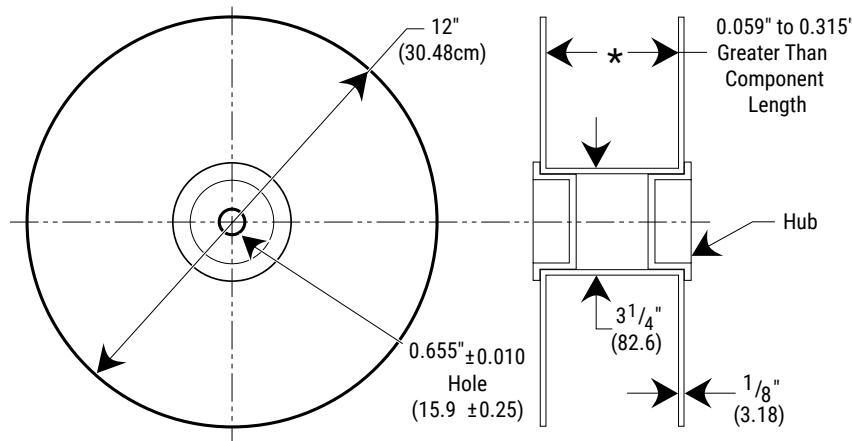

Figure 3

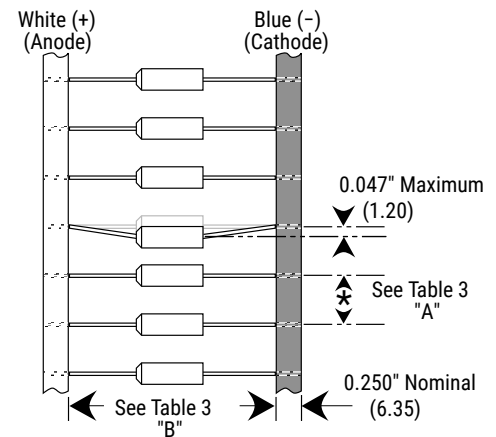

Table 3 – Tape Dimensions

| Component Body Diameter | Component Pitch "A" | Inside Tape Spacing "B" ±1.5 mm (0.059") | | |
|------------------------------------|---------------------|--|-----------|---------|
| | | I | II | III |
| 0" (0 mm) to 0.197" (5 mm) | 0.200" or (±0.5 mm) | 2.062" | 2.500" | 2.874" |
| 0.197" (5.01 mm) to 0.394" (10 mm) | 0.400 or (10 mm) | (52.4 mm) | (63.5 mm) | (73 mm) |

Capacitors are reeled so that positive leads are oriented as shown in Figure 3. Kraft paper (50lb. test minimum) is inserted between the layers of capacitors wound on reels for component pitch ≤ 0.200 " sizes and corrugated paper (70 lb. test minimum), single faced is inserted for component pitch ≥ 0.400 " sizes. Capacitor lead length may extend only a maximum of 0.031" (0.8 mm) beyond the tape's edges. Capacitors are centered in a row between the two tapes and will deviate only ± 0.031 " (0.79 mm) from the row center. Figures 1 and 2 show the KEMET standard chipboard tape reel. A minimum of 36" (91.5 cm) leader tape is provided at each end of the reeled capacitors. Universal splicing clips are used to connect the tape.

KEMET Electronics Corporation Sales Offices

For a complete list of our global sales offices, please visit www.kemet.com/sales.

Disclaimer

All product specifications, statements, information and data (collectively, the "Information") in this datasheet are subject to change. The customer is responsible for checking and verifying the extent to which the Information contained in this publication is applicable to an order at the time the order is placed. All Information given herein is believed to be accurate and reliable, but it is presented without guarantee, warranty, or responsibility of any kind, expressed or implied.

Statements of suitability for certain applications are based on KEMET Electronics Corporation's ("KEMET") knowledge of typical operating conditions for such applications, but are not intended to constitute – and KEMET specifically disclaims – any warranty concerning suitability for a specific customer application or use. The Information is intended for use only by customers who have the requisite experience and capability to determine the correct products for their application. Any technical advice inferred from this Information or otherwise provided by KEMET with reference to the use of KEMET's products is given gratis, and KEMET assumes no obligation or liability for the advice given or results obtained.

Although KEMET designs and manufactures its products to the most stringent quality and safety standards, given the current state of the art, isolated component failures may still occur. Accordingly, customer applications which require a high degree of reliability or safety should employ suitable designs or other safeguards (such as installation of protective circuitry or redundancies) in order to ensure that the failure of an electrical component does not result in a risk of personal injury or property damage.

Although all product-related warnings, cautions and notes must be observed, the customer should not assume that all safety measures are indicated or that other measures may not be required.

KEMET is a registered trademark of KEMET Electronics Corporation.