

R76H, 125°C Double Metallized Polypropylene Film, Radial, DC and Pulse Applications (Automotive Grade)

Overview

The R76H Series is constructed of polypropylene film and double metallized polyester film as electrodes with radial leads of tinned wire. The radial leads are electrically welded to the metal layer on the ends of the capacitor winding. The capacitor is encapsulated in a self-extinguishing solvent resistant plastic case with thermosetting resin material meeting UL 94 V-0 requirements. Two different winding constructions are used depending on voltage parameters. Please see the Performance Characteristics for more information.

Automotive grade devices meet the demanding Automotive Electronics Council's AEC-Q200 qualification requirements.

Applications

Typical applications include resonant circuit, high frequency high current, snubber and silicon-controlled rectifier (SCR and IGBT) and SiC (e.g. MOSFET) commutation circuits as well as applications with high voltage and high current in combination with a high ambient temperature.

Not suitable for across-the-line application (see Suppressor Capacitors).

Benefits

- Voltage range: 250 – 2,000 VDC
- Capacitance range: 100 pF – 15 μ F
- Lead Spacing: 10 mm – 37.5 mm
- Capacitance tolerance: \pm 2.5%, \pm 5%, \pm 10%
- Climatic category: 55/125/56 IEC 60068-1
- Operating temperature range of -55°C to $+125^{\circ}\text{C}$
- Usable in harsh environment at $85^{\circ}\text{C}/85\%$ R.H. up to 1,000 hours
- RoHS compliance and lead-free terminations
- Tape & Reel packaging in accordance with IEC 60286-2
- Self-healing
- Automotive (AEC-Q200) grade

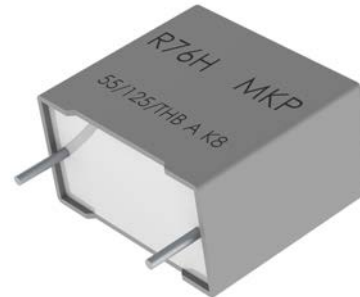

Part Number System

R76	T	R	3330	SE	30		K
Series	Rated Voltage (VDC)	Lead Spacing (mm)	Capacitance Code (pF)	Packaging	Internal Use		Capacitance Tolerance
Double Metallized Polypropylene	I = 250 M = 400 P = 630 Q = 1,000 T = 1,600 U = 2,000	F = 10 I = 15 N = 22.5 R = 27.5 W = 37.5	The last three digits represent significant figures. The first digit specifies the total number of zeros to be added.	See Ordering Options Table	H0 H1 H2 H3 H4	H5 H6 H7 H8 HL	H = \pm 2.5% (*) J = \pm 5% K = \pm 10% (*) = for C \geq 1,000 pF

One world. One KEMET

Ordering Options Table

Lead Spacing Nominal (mm)	Type of Leads and Packaging	Lead Length (mm)	Lead and Packaging Code
10 15 22.5	Standard Lead and Packaging Options		
	Bulk (Bag) – Short Leads	4 +2/-0	SE
	Ammo Pack	H ₀ = 18.5±0.5	DQ
	Other Lead and Packaging Options		
	Tape & Reel (Standard Reel Ø 355 mm)	H ₀ = 18.5±0.5	GY
	Tape & Reel (Large Reel Ø 500 mm)	H ₀ = 18.5±0.5	CK
	Bulk (Bag) – Short Leads	2.7 +0.5/-0	JA
	Bulk (Bag) – Short Leads	3.5 +0.5/-0	JB
	Bulk (Bag) – Short Leads	10±1	JC
	Bulk (Bag) – Short Leads	4.0 +0.5/-0	JE
	Bulk (Bag) – Short Leads	3.2 +0.3/-0.2	JH
	Bulk (Bag) – Long Leads	18±1	JM
	Bulk (Bag) – Long Leads	30 +5/-0	40
Bulk (Bag) – Long Leads	25 +2/-1	50	
27.5	Standard Lead and Packaging Options		
	Bulk (Tray) – Short Leads	4 +2/-0	SE
	Other Lead and Packaging Options		
	Tape & Reel (Standard Reel Ø 355 mm)	H ₀ = 18.5±0.5	GY
	Tape & Reel (Large Reel Ø 500 mm)	H ₀ = 18.5±0.5	CK ¹
	Bulk (Tray) – Short Leads	3.5 +0.5/-0	JB
	Bulk (Tray) – Short Leads	4.0 +0.5/-0	JE
	Bulk (Tray) – Short Leads	3.2 +0.3/-0.2	JH
	Bulk (Tray) – Long Leads	30 +5/-0	40
Bulk (Tray) – Long Leads	25 +2/-1	50	
37.5	Standard Lead and Packaging Options		
	Bulk (Tray) – Short Leads	4 +2/-0	SE
	Other Lead and Packaging Options		
	Bulk (Tray) – Short Leads	3.5 +0.5/-0	JB
	Bulk (Tray) – Short Leads	4.0 +0.5/-0	JE
	Bulk (Tray) – Short Leads	3.2 +0.3/-0.2	JH
	Bulk (Tray) – Long Leads	30 +5/-0	40
Bulk (Tray) – Long Leads	25 +2/-1	50	

¹ = Not for all sizes, see "Packaging Quantities" table.

Dimensions – Millimeters



S		T		H		L		F	
Nominal	Tolerance	Nominal	Tolerance	Nominal	Tolerance	Nominal	Tolerance	Nominal	Tolerance
10.0	±0.4	4.0	+0.2/-0.5	9.0	+0.1/-0.5	13.0	+0.2/-0.5	0.6	±0.05
10.0	±0.4	5.0	+0.2/-0.5	11.0	+0.1/-0.5	13.0	+0.2/-0.5	0.6	±0.05
10.0	±0.4	6.0	+0.2/-0.5	12.0	+0.1/-0.5	13.0	+0.2/-0.5	0.6	±0.05
15.0	±0.4	4.0	+0.2/-0.5	10.0	+0.1/-0.5	18.0	+0.3/-0.5	0.8	±0.05
15.0	±0.4	5.0	+0.2/-0.5	11.0	+0.1/-0.5	18.0	+0.3/-0.5	0.8	±0.05
15.0	±0.4	6.0	+0.2/-0.5	12.0	+0.1/-0.5	18.0	+0.3/-0.5	0.8	±0.05
15.0	±0.4	7.5	+0.2/-0.5	13.5	+0.1/-0.5	18.0	+0.5/-0.5	0.8	±0.05
15.0	±0.4	8.5	+0.2/-0.5	14.5	+0.1/-0.5	18.0	+0.5/-0.5	0.8	±0.05
15.0	±0.4	9.0	+0.2/-0.5	12.5	+0.1/-0.5	18.0	+0.5/-0.5	0.8	±0.05
15.0	±0.4	10.0	+0.2/-0.5	16.0	+0.1/-0.5	18.0	+0.5/-0.5	0.8	±0.05
15.0	±0.4	11.0	+0.2/-0.5	19.0	+0.1/-0.5	18.0	+0.5/-0.5	0.8	±0.05
15.0	±0.4	13.0	+0.2/-0.5	12.0	+0.1/-0.5	18.0	+0.5/-0.5	0.8	±0.05
22.5	±0.4	6.0	+0.2/-0.5	15.0	+0.1/-0.5	26.5	+0.3/-0.5	0.8	±0.05
22.5	±0.4	7.0	+0.2/-0.5	16.0	+0.1/-0.5	26.5	+0.3/-0.5	0.8	±0.05

Note: See Ordering Options Table for lead length (LL/Ho) options.

Dimensions – Millimeters cont.



S		T		H		L		F	
Nominal	Tolerance	Nominal	Tolerance	Nominal	Tolerance	Nominal	Tolerance	Nominal	Tolerance
22.5	±0.4	8.5	+0.2/-0.5	17.0	+0.1/-0.5	26.5	+0.3/-0.5	0.8	±0.05
22.5	±0.4	10.0	+0.2/-0.5	18.5	+0.1/-0.5	26.5	+0.3/-0.5	0.8	±0.05
22.5	±0.4	11.0	+0.2/-0.5	20.0	+0.1/-0.5	26.5	+0.3/-0.5	0.8	±0.05
22.5	±0.4	13.0	+0.2/-0.5	22.0	+0.1/-0.5	26.5	+0.3/-0.5	0.8	±0.05
27.5	±0.4	9.0	+0.2/-0.7	17.0	+0.1/-0.7	32.0	+0.3/-0.7	0.8	±0.05
27.5	±0.4	11.0	+0.2/-0.7	20.0	+0.1/-0.7	32.0	+0.3/-0.7	0.8	±0.05
27.5	±0.4	13.0	+0.2/-0.7	22.0	+0.1/-0.7	32.0	+0.3/-0.7	0.8	±0.05
27.5	±0.4	13.0	+0.2/-0.7	25.0	+0.1/-0.7	32.0	+0.3/-0.7	0.8	±0.05
27.5	±0.4	14.0	+0.2/-0.7	28.0	+0.1/-0.7	32.0	+0.3/-0.7	0.8	±0.05
27.5	±0.4	18.0	+0.2/-0.7	33.0	+0.1/-0.7	32.0	+0.3/-0.7	0.8	±0.05
27.5	±0.4	22.0	+0.2/-0.7	37.0	+0.1/-0.7	32.0	+0.3/-0.7	0.8	±0.05
37.5	±0.4	11.0	+0.3/-0.7	22.0	+0.1/-0.7	41.5	+0.3/-0.7	1.0	±0.05
37.5	±0.4	13.0	+0.3/-0.7	24.0	+0.1/-0.7	41.5	+0.3/-0.7	1.0	±0.05
37.5	±0.4	16.0	+0.3/-0.7	28.5	+0.1/-0.7	41.5	+0.3/-0.7	1.0	±0.05
37.5	±0.4	19.0	+0.3/-0.7	32.0	+0.1/-0.7	41.5	+0.3/-0.7	1.0	±0.05
37.5	±0.4	20.0	+0.3/-0.7	40.0	+0.1/-0.7	41.5	+0.3/-0.7	1.0	±0.05
37.5	±0.4	24.0	+0.3/-0.7	44.0	+0.1/-0.7	41.5	+0.3/-0.7	1.0	±0.05
37.5	±0.4	24.0	+0.3/-0.7	15.0	+0.1/-0.7	41.5	+0.3/-0.7	1.0	±0.05
37.5	±0.4	24.0	+0.3/-0.7	19.0	+0.1/-0.7	41.5	+0.3/-0.7	1.0	±0.05
37.5	±0.4	30.0	+0.3/-0.7	45.0	+0.1/-0.7	41.5	+0.3/-0.7	1.0	±0.05

Note: See Ordering Options Table for lead length (LL/Ho) options.

Performance Characteristics

Dielectric	Polypropylene film						
Plates	Double sided metallized polyester film						
Winding	Non-inductive type						
Leads	Tinned wire						
Protection	Plastic case, thermosetting resin filled. Box material is solvent resistant and flame retardant according to UL94.						
Related Documents	IEC 60384-16						
Sections	1			2			
Rated Voltage V_R	250 VDC 180 VAC	400 VDC 250 VAC	630 VDC 400 VAC	1,000 VDC 600 VAC	1,600 VDC 650 VAC	2,000 VDC 700 VAC	
Capacitance Range (μF)	0.027- 12	0.01 - 8.2	0.0039 - 4.7	0.00047 - 2.2	0.0033 - 1.2	0.00056 - 0.56	
Capacitance Values	E12 series (IEC 60063) measured at 1 kHz and +20 \pm 1°C						
Capacitance Tolerance	\pm 2.5%, \pm 5%, \pm 10%						
Operating Temperature Range	-55°C to +125°C						
Rated Temperature T_R	+105°C for V_R (DC and AC)						
Voltage Derating	The following decreasing factor has to be applied on the rated voltage: +105°C to 125°C: 1.25% per °C for V_R (DC and AC) = operating voltage V_{op}						
Climatic Category	55/125/56 IEC 60068-1						
Storage Conditions	Storage time: \leq 24 months from the date marked on the package label						
	Average relative humidity per year \leq 70%						
	RH \leq 85% for 30 days randomly distributed throughout the year						
	Dew is absent						
	Temperature: -40 to 80°C (see "Maximum Humidity in Storage Conditions" graph below)						
Test Voltage	1.6 x V_R VDC for 2 seconds (between terminations) at +25°C \pm 5°C						
Capacitance Drift	Maximum 0.5% after a 2 year storage period at a temperature of +10°C to +40°C and a relative humidity of 40% to 60%						
Maximum Pulse Steepness	dV/dt according to Table 1. For working voltages lower than rated voltage ($V < V_R$), the specified dV/dt can be multiplied by the factor V_R/V .						
Reliability (Reference IEC 61709)	Operational life at V_{op} (DC) > 200,000 hours at 85°C; 6,000 hours at 110°C; 3,000 hours at 125°C						
	Failure rate \leq 1 FIT, $T = +40^\circ\text{C}$, $V = 0.5 \times V_R$						
	Failure criteria: open or short circuit, capacitance change > 10%, DF 2 times the catalog limits, IR < 0.005 x initial limit						
Temperature Coefficient	-(200 \pm 100) ppm/°C at 1 kHz						
Self-Inductance (Lead Length ~ 2 mm)	Lead Spacing (mm)	7.5	10	15	22.5	27.5	37.5
	L (nH) \approx	8	9	10	16	18	20
	Maximum 1 nH per 1 mm lead and capacitor length.						

Performance Characteristics cont.

Dissipation Factor $\tan\delta$	Measured at 25°C ±5°C			
	Frequency	C ≤ 0.1 μF	0.1 μF < C ≤ 1.0 μF	C > 1μF
	1 kHz	≤ 0.03%	≤ 0.03%	≤ 0.04%
	10 kHz	≤ 0.04%	≤ 0.06%	-
100 kHz	≤ 0.10%	-	-	

Insulation Resistance	Measured at +25°C, 100 VDC 60 seconds	
	Minimum Values Between Terminals	
	C ≤ 0.33 μF	C > 0.33 μF
	≥ 100,000 MΩ (≥ 500,000 MΩ)*	≥ 30,000 MΩ · μF (≥ 150,000 MΩ · μF)*

* Typical value

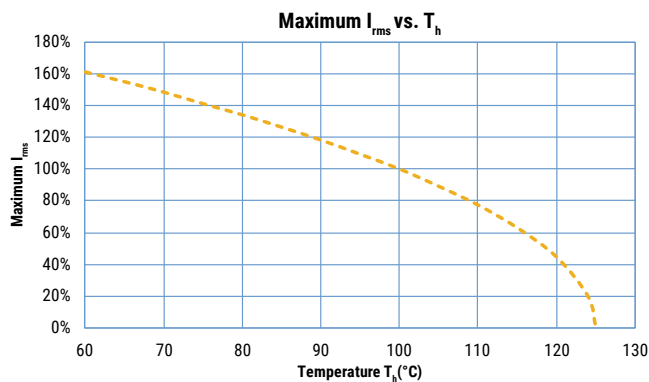
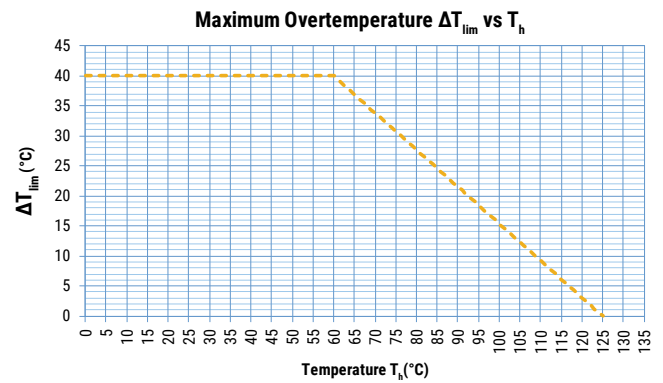
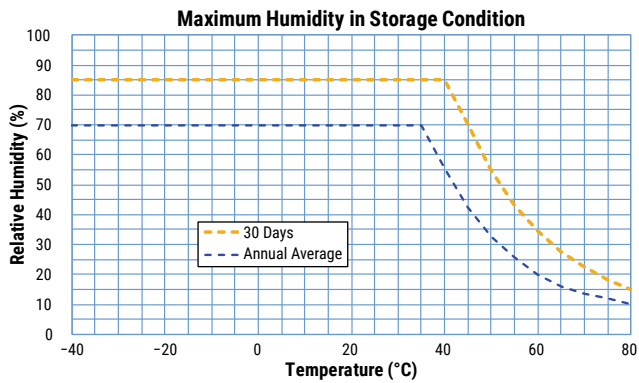

T_h is the maximum ambient temperature surrounding the capacitor or hottest contact point (e.g. tracks), whichever is higher, in the worst operation conditions in °C.

Qualification

Automotive Grade products meet or exceed the requirements outlined by the Automotive Electronics Council. Details regarding test methods and conditions are referenced in document AEC-Q200, Stress Test Qualification for Passive Components. For additional information regarding the Automotive Electronics Council and AEC-Q200, please visit their website at www.aecouncil.com.

Maximum Voltage (V_{rms}) Versus Frequency (Sinusoidal Waveform/ $Th \leq 100^\circ C$)

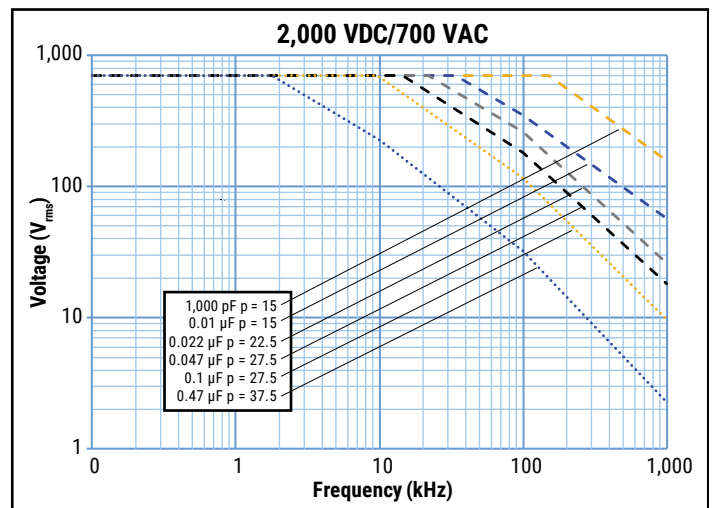
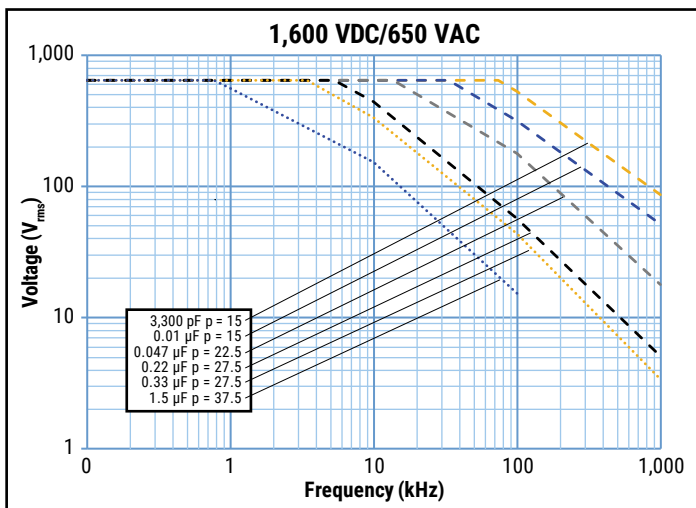
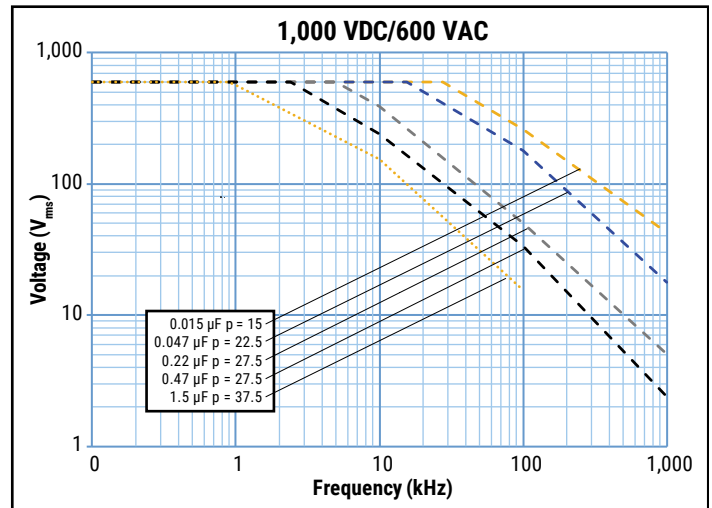
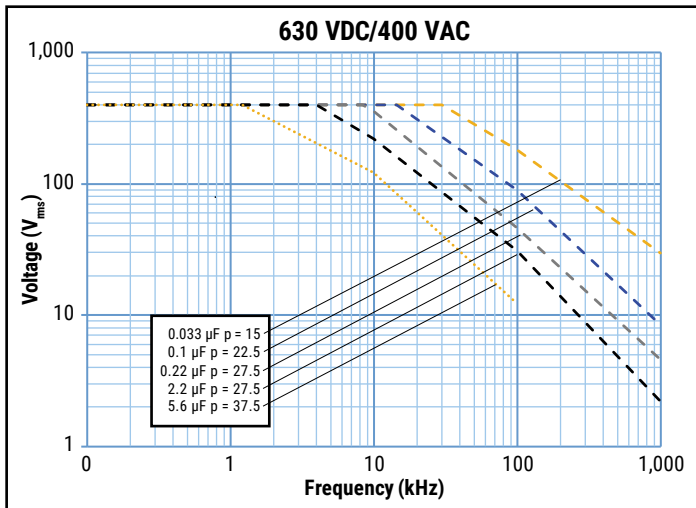
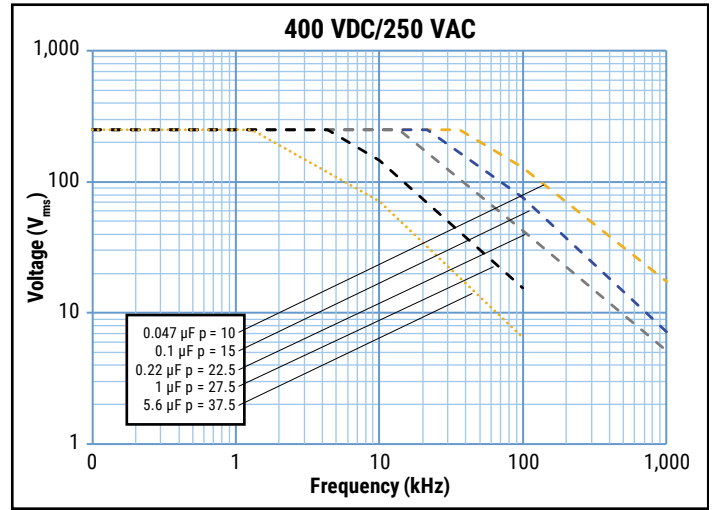
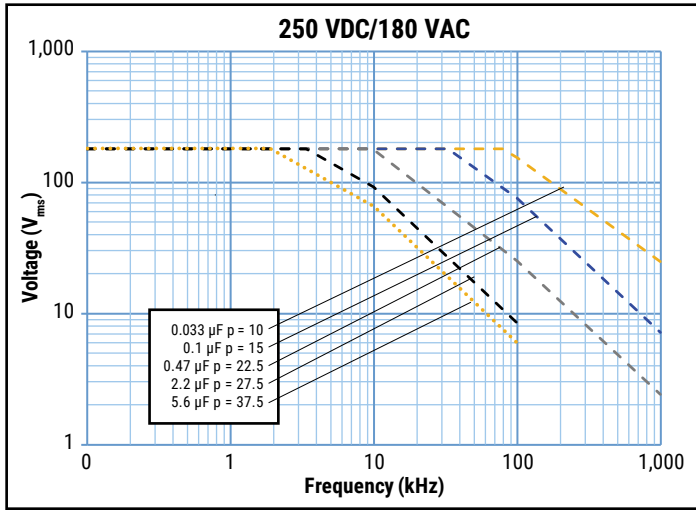

Maximum Current (I_{rms}) Versus Frequency (Sinusoidal Waveform/ $Th \leq 100^\circ C$)

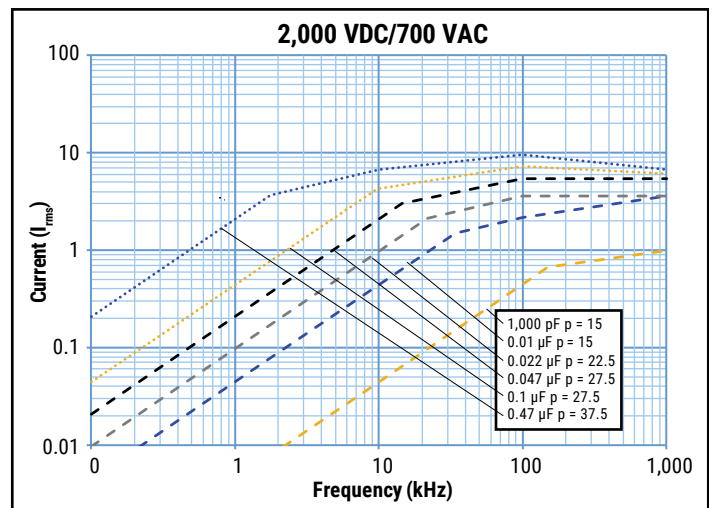
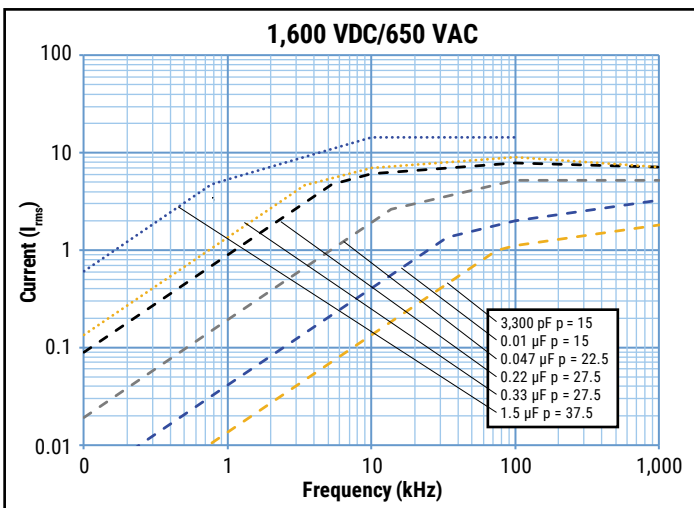
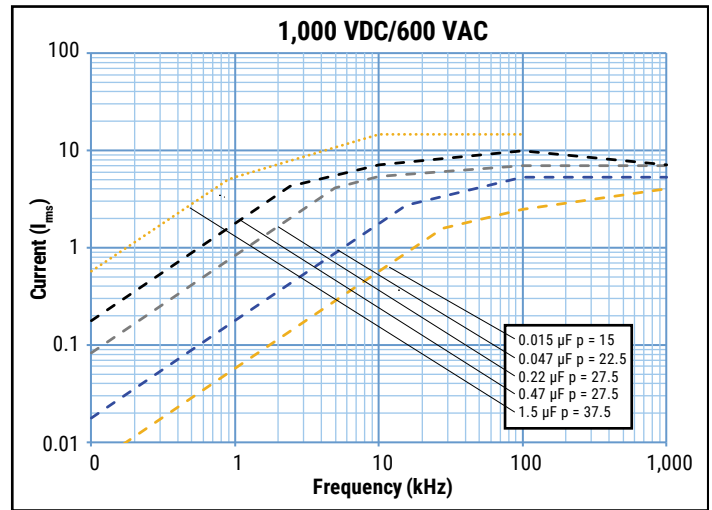
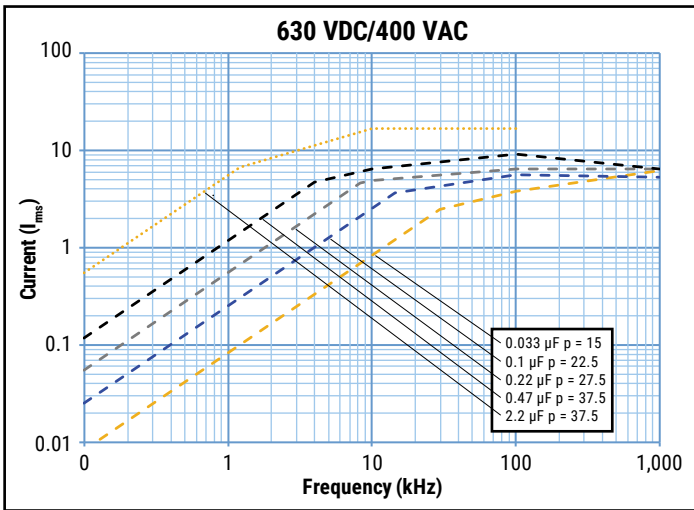
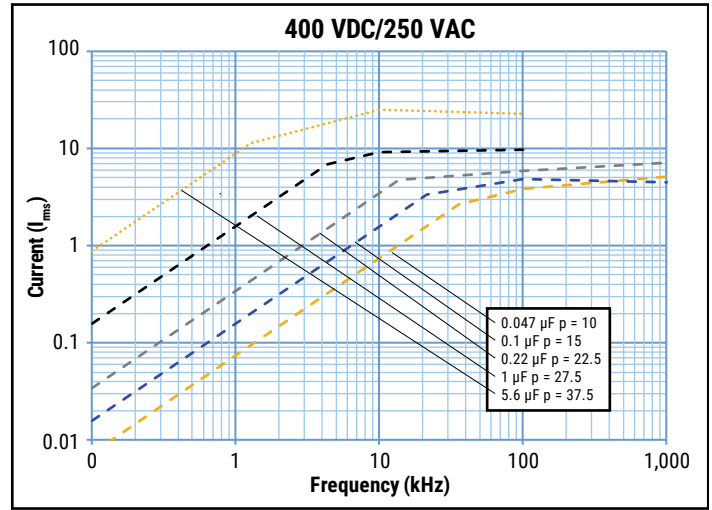
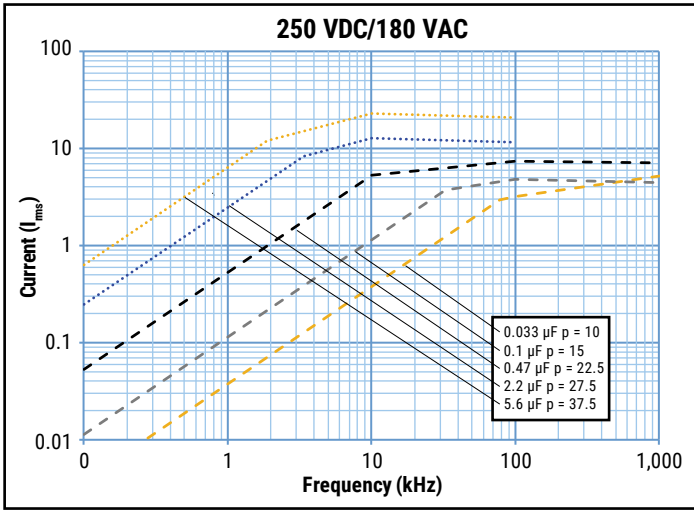

Environmental Test Data

Damp Heat, Steady State Test	Test Conditions:		Performances
	Temperature: Relative humidity (RH): Test duration:	+40°C ±2°C 93% ±2% 56 days	Δ C/C ≤ 2%, Δ tanδ ≤ 0.001 at 1 kHz IR after test ≥ 50% of initial limit
Endurance Test	Test Conditions		Performances
	Temperature: Voltage applied: Test duration:	+105°C ±2°C 1.25 x V _R (DC) 2,000 hours	Δ C/C ≤ 2%, Δ tanδ ≤ 0.001 at 10 kHz for C ≤ 1 μF Δ tanδ ≤ 0.001 at 1 kHz for C > 1 μF IR after test ≥ 50% of initial limit
	Temperature: Relative humidity (RH): Voltage applied: Test duration:	+85°C ±2°C 85% ±2% 1.0 x VR (AC), 50/60 Hz 1,000 hours	Δ C/C ≤ 10%, Δ tanδ ≤ 0.001 at 1 kHz IR after test ≥ 50% of initial limit
	Temperature: Relative humidity (RH): Voltage applied: Test duration:	+85°C ±2°C 85% ±2% 1.0 x VR (DC) 1,000 hours	Δ C/C ≤ 10%, Δ tanδ ≤ 0.001 at 1 kHz IR after test ≥ 50% of initial limit
Resistance to Soldering Heat Test	Test Conditions		Performances
	Solder bath temperature: Dipping time (with heat screen):	260°C ±5°C 10 seconds ±1 second	Δ C/C ≤ 1%, Δ tanδ ≤ 0.001 at 10 kHz for C ≤ 1 μF Δ tanδ ≤ 0.001 at 1 kHz for C > 1 μF IR after test ≥ initial limit

Environmental Compliance

All KEMET pulse capacitors are RoHS compliant.



Table 1 – Ratings & Part Number Reference

VDC	VAC	Cap Value (µF)	Dimensions in mm			Lead Spacing (S)	dV/dt (V/µs)	Max K ₀ (V ² /µs)	I _{pk}	ESL		ESR	I _{rms} max (*)	Rth	KEMET Internal Part Number	Customer Part Number
										Lead Length 2x 4 mm	at 100 kHz	at 100 kHz, 100°C		(°C/W)		
			A _{pk}	nH	mΩ				A _{rms}	(°C/W)						
250	180	0.0270	4.0	9.0	13.0	10.0	1,000	500,000	27	9	24	2.88	79	761F2270(1)H3(2)	R761F2270(1)H3(2)	
250	180	0.0330	4.0	9.0	13.0	10.0	1,000	500,000	33	9	19	3.19	79	761F2330(1)H3(2)	R761F2330(1)H3(2)	
250	180	0.0390	4.0	9.0	13.0	10.0	1,000	500,000	39	9	16	3.46	79	761F2390(1)H3(2)	R761F2390(1)H3(2)	
250	180	0.0470	5.0	11.0	13.0	10.0	1,000	500,000	47	9	14	4.05	69	761F2470(1)H3(2)	R761F2470(1)H3(2)	
250	180	0.0560	5.0	11.0	13.0	10.0	1,000	500,000	56	9	23	3.13	69	761F2560(1)H3(2)	R761F2560(1)H3(2)	
250	180	0.0680	6.0	12.0	13.0	10.0	1,000	500,000	68	9	19	3.59	64	761F2680(1)H3(2)	R761F2680(1)H3(2)	
250	180	0.0820	6.0	12.0	13.0	10.0	1,000	500,000	82	9	16	3.94	64	761F2820(1)H3(2)	R761F2820(1)H3(2)	
250	180	0.0680	5.0	11.0	18.0	15.0	550	275,000	37	10	19	3.69	60	761I2680(1)H3(2)	R761I2680(1)H3(2)	
250	180	0.0820	5.0	11.0	18.0	15.0	550	275,000	45	10	16	4.06	60	761I2820(1)H3(2)	R761I2820(1)H3(2)	
250	180	0.1000	5.0	11.0	18.0	15.0	550	275,000	55	10	13	4.48	60	761I3100(1)H3(2)	R761I3100(1)H3(2)	
250	180	0.1200	6.0	12.0	18.0	15.0	550	275,000	66	10	13	4.55	56	761I3120(1)H3(2)	R761I3120(1)H3(2)	
250	180	0.1500	6.0	12.0	18.0	15.0	550	275,000	83	10	11	5.09	56	761I3150(1)H3(2)	R761I3150(1)H3(2)	
250	180	0.1800	7.5	13.5	18.0	15.0	550	275,000	99	10	9	5.86	51	761I3180(1)H3(2)	R761I3180(1)H3(2)	
250	180	0.1800	9.0	12.5	18.0	15.0	550	275,000	99	10	9	5.92	50	761I3180(1)H7(2)	R761I3180(1)H7(2)	
250	180	0.2200	7.5	13.5	18.0	15.0	550	275,000	121	10	7	6.48	51	761I3220(1)H3(2)	R761I3220(1)H3(2)	
250	180	0.2200	9.0	12.5	18.0	15.0	550	275,000	121	10	7	6.55	50	761I3220(1)H7(2)	R761I3220(1)H7(2)	
250	180	0.2700	8.5	14.5	18.0	15.0	550	275,000	149	10	6	7.39	48	761I3270(1)H3(2)	R761I3270(1)H3(2)	
250	180	0.2700	9.0	12.5	18.0	15.0	550	275,000	149	10	6	7.25	50	761I3270(1)H7(2)	R761I3270(1)H7(2)	
250	180	0.3300	10.0	16.0	18.0	15.0	550	275,000	182	10	5	8.51	44	761I3330(1)H3(2)	R761I3330(1)H3(2)	
250	180	0.3300	13.0	12.0	18.0	15.0	550	275,000	182	10	5	8.43	45	761I3330(1)H7(2)	R761I3330(1)H7(2)	
250	180	0.3900	10.0	16.0	18.0	15.0	550	275,000	215	10	4	9.25	44	761I3390(1)H3(2)	R761I3390(1)H3(2)	
250	180	0.4700	11.0	19.0	18.0	15.0	550	275,000	259	10	3	10.62	40	761I3470(1)H3(2)	R761I3470(1)H3(2)	
250	180	0.2200	6.0	15.0	26.5	22.5	300	150,000	66	16	7	7.00	43	761N3220(1)H0(2)	R761N3220(1)H0(2)	
250	180	0.2700	6.0	15.0	26.5	22.5	300	150,000	81	16	6	7.75	43	761N3270(1)H3(2)	R761N3270(1)H3(2)	
250	180	0.3300	6.0	15.0	26.5	22.5	300	150,000	99	16	5	8.57	43	761N3330(1)H3(2)	R761N3330(1)H3(2)	
250	180	0.3900	7.0	16.0	26.5	22.5	300	150,000	117	16	4	9.58	41	761N3390(1)H3(2)	R761N3390(1)H3(2)	
250	180	0.4700	7.0	16.0	26.5	22.5	300	150,000	141	16	3	10.52	41	761N3470(1)H3(2)	R761N3470(1)H3(2)	
250	180	0.5600	8.5	17.0	26.5	22.5	300	150,000	168	16	3	11.87	38	761N3560(1)H3(2)	R761N3560(1)H3(2)	
250	180	0.6800	10.0	18.5	26.5	22.5	300	150,000	204	16	2	13.55	36	761N3680(1)H3(2)	R761N3680(1)H3(2)	
250	180	0.8200	10.0	18.5	26.5	22.5	300	150,000	246	16	2	14.88	36	761N3820(1)H3(2)	R761N3820(1)H3(2)	
250	180	1.0000	11.0	20.0	26.5	22.5	300	150,000	300	16	7	7.95	34	761N4100(1)H3(2)	R761N4100(1)H3(2)	
250	180	1.2000	13.0	22.0	26.5	22.5	300	150,000	360	16	16	5.55	31	761N4120(1)H3(2)	R761N4120(1)H3(2)	
250	180	1.0000	11.0	20.0	32.0	27.5	200	100,000	200	18	7	8.27	31	761R4100(1)H3(2)	R761R4100(1)H3(2)	
250	180	1.2000	11.0	20.0	32.0	27.5	200	100,000	240	18	16	5.55	31	761R4120(1)H4(2)	R761R4120(1)H4(2)	
250	180	1.5000	13.0	22.0	32.0	27.5	200	100,000	300	18	13	6.44	29	761R4150(1)H3(2)	R761R4150(1)H3(2)	
250	180	1.8000	13.0	25.0	32.0	27.5	200	100,000	360	18	11	7.23	28	761R4180(1)H2(2)	R761R4180(1)H2(2)	
250	180	2.2000	14.0	28.0	32.0	27.5	200	100,000	440	18	9	8.24	26	761R4220(1)H4(2)	R761R4220(1)H4(2)	
250	180	2.7000	18.0	33.0	32.0	27.5	200	100,000	540	18	7	9.73	23	761R4270(1)H3(2)	R761R4270(1)H3(2)	
250	180	3.3000	18.0	33.0	32.0	27.5	200	100,000	660	18	6	10.76	23	761R4330(1)H3(2)	R761R4330(1)H3(2)	
250	180	3.9000	18.0	33.0	32.0	27.5	200	100,000	780	18	5	11.70	23	761R4390(1)H3(2)	R761R4390(1)H3(2)	
250	180	4.7000	22.0	37.0	32.0	27.5	200	100,000	940	18	4	13.50	21	761R4470(1)H3(2)	R761R4470(1)H3(2)	
250	180	5.6000	22.0	37.0	32.0	27.5	200	100,000	1,120	18	3	14.74	21	761R4560(1)H4(2)	R761R4560(1)H4(2)	
250	180	1.2000	11.0	22.0	41.5	37.5	100	50,000	120	20	16	5.97	27	761W4120(1)H3(2)	R761W4120(1)H3(2)	
250	180	1.5000	11.0	22.0	41.5	37.5	100	50,000	150	20	13	6.68	27	761W4150(1)H3(2)	R761W4150(1)H3(2)	
250	180	1.5000	24.0	15.0	41.5	37.5	100	50,000	150	20	13	7.04	24	761W4150(1)HL(2)	R761W4150(1)HL(2)	
250	180	1.8000	11.0	22.0	41.5	37.5	100	50,000	180	20	11	7.31	27	761W4180(1)H3(2)	R761W4180(1)H3(2)	
250	180	1.8000	24.0	15.0	41.5	37.5	100	50,000	180	20	11	7.71	24	761W4180(1)HL(2)	R761W4180(1)HL(2)	
250	180	2.2000	13.0	24.0	41.5	37.5	100	50,000	220	20	9	8.37	25	761W4220(1)H3(2)	R761W4220(1)H3(2)	
250	180	2.2000	24.0	15.0	41.5	37.5	100	50,000	220	20	9	8.52	24	761W4220(1)HL(2)	R761W4220(1)HL(2)	
250	180	2.7000	16.0	28.5	41.5	37.5	100	50,000	270	20	7	9.82	23	761W4270(1)H2(2)	R761W4270(1)H2(2)	
250	180	2.7000	24.0	19.0	41.5	37.5	100	50,000	270	20	7	9.75	23	761W4270(1)HL(2)	R761W4270(1)HL(2)	

(1) Insert lead and packaging code. See Ordering Options Table for available options.

(2) H = 2.5% (only for C ≥ 1,000 pF), J = 5%, K = 10%

(*) I_{rms} value that leads to a ΔT of ≈ 15°C in the hot spot > T_{HS} = T_{AMB} + ΔT = 100°C + 15°C = 115°C

Table 1 – Ratings & Part Number Reference cont.

VDC	VAC	Cap Value (µF)	Dimensions in mm			Lead Spacing (S)	dV/dt (V/µs)	Max K ₀ (V ² /µs)	I _{pk}	ESL	ESR	I _{rms} max (*)	Rth	KEMET Internal Part Number	Customer Part Number
			T	H	L										
250	180	3.3000	16.0	28.5	41.5	37.5	100	50,000	330	20	6	10.86	23	76IW4330(1)H3(2)	R76IW4330(1)H3(2)
250	180	3.3000	24.0	19.0	41.5	37.5	100	50,000	330	20	6	10.78	23	76IW4330(1)HL(2)	R76IW4330(1)HL(2)
250	180	3.9000	16.0	28.5	41.5	37.5	100	50,000	390	20	5	11.80	23	76IW4390(1)H3(2)	R76IW4390(1)H3(2)
250	180	4.7000	19.0	32.0	41.5	37.5	100	50,000	470	20	4	13.53	21	76IW4470(1)H3(2)	R76IW4470(1)H3(2)
250	180	5.6000	20.0	40.0	41.5	37.5	100	50,000	560	20	3	15.51	19	76IW4560(1)H2(2)	R76IW4560(1)H2(2)
250	180	6.8000	20.0	40.0	41.5	37.5	100	50,000	680	20	3	17.09	19	76IW4680(1)H3(2)	R76IW4680(1)H3(2)
250	180	8.2000	24.0	44.0	41.5	37.5	100	50,000	820	20	2	19.58	17	76IW4820(1)H2(2)	R76IW4820(1)H2(2)
250	180	10.0000	24.0	44.0	41.5	37.5	100	50,000	1,000	20	2	21.62	17	76IW5100(1)H3(2)	R76IW5100(1)H3(2)
250	180	12.0000	30.0	45.0	41.5	37.5	100	50,000	1,200	20	2	24.56	16	76IW5120(1)H3(2)	R76IW5120(1)H3(2)
400	250	0.0100	4.0	9.0	13.0	10.0	1,500	1,200,000	15	9	64	1.57	79	76MF2100(1)H0(2)	R76MF2100(1)H0(2)
400	250	0.0120	4.0	9.0	13.0	10.0	1,500	1,200,000	18	9	53	1.88	79	76MF2120(1)H0(2)	R76MF2120(1)H0(2)
400	250	0.0150	4.0	9.0	13.0	10.0	1,500	1,200,000	23	9	42	2.15	79	76MF2150(1)H3(2)	R76MF2150(1)H3(2)
400	250	0.0180	4.0	9.0	13.0	10.0	1,500	1,200,000	27	9	35	2.35	79	76MF2180(1)H3(2)	R76MF2180(1)H3(2)
400	250	0.0220	4.0	9.0	13.0	10.0	1,500	1,200,000	33	9	29	2.60	79	76MF2220(1)H3(2)	R76MF2220(1)H3(2)
400	250	0.0270	5.0	11.0	13.0	10.0	1,500	1,200,000	41	9	24	3.07	69	76MF2270(1)H3(2)	R76MF2270(1)H3(2)
400	250	0.0330	5.0	11.0	13.0	10.0	1,500	1,200,000	50	9	19	3.40	69	76MF2330(1)H3(2)	R76MF2330(1)H3(2)
400	250	0.0390	6.0	12.0	13.0	10.0	1,500	1,200,000	59	9	16	3.84	64	76MF2390(1)H3(2)	R76MF2390(1)H3(2)
400	250	0.0470	6.0	12.0	13.0	10.0	1,500	1,200,000	71	9	14	4.22	64	76MF2470(1)H3(2)	R76MF2470(1)H3(2)
400	250	0.0330	5.0	11.0	18.0	15.0	900	720,000	30	10	19	3.64	60	76MI2330(1)H0(2)	R76MI2330(1)H0(2)
400	250	0.0390	5.0	11.0	18.0	15.0	900	720,000	35	10	16	3.96	60	76MI2390(1)H3(2)	R76MI2390(1)H3(2)
400	250	0.0470	5.0	11.0	18.0	15.0	900	720,000	42	10	14	4.34	60	76MI2470(1)H3(2)	R76MI2470(1)H3(2)
400	250	0.0560	5.0	11.0	18.0	15.0	900	720,000	50	10	23	3.35	60	76MI2560(1)H3(2)	R76MI2560(1)H3(2)
400	250	0.0680	6.0	12.0	18.0	15.0	900	720,000	61	10	19	3.83	56	76MI2680(1)H3(2)	R76MI2680(1)H3(2)
400	250	0.0820	6.0	12.0	18.0	15.0	900	720,000	74	10	16	4.21	56	76MI2820(1)H3(2)	R76MI2820(1)H3(2)
400	250	0.1000	7.5	13.5	18.0	15.0	900	720,000	90	10	13	4.88	51	76MI3100(1)H3(2)	R76MI3100(1)H3(2)
400	250	0.1000	9.0	12.5	18.0	15.0	900	720,000	90	10	13	4.93	50	76MI3100(1)H7(2)	R76MI3100(1)H7(2)
400	250	0.1200	7.5	13.5	18.0	15.0	900	720,000	108	10	13	4.78	51	76MI3120(1)H3(2)	R76MI3120(1)H3(2)
400	250	0.1200	9.0	12.5	18.0	15.0	900	720,000	108	10	13	4.83	50	76MI3120(1)H7(2)	R76MI3120(1)H7(2)
400	250	0.1500	8.5	14.5	18.0	15.0	900	720,000	135	10	11	5.51	48	76MI3150(1)H3(2)	R76MI3150(1)H3(2)
400	250	0.1500	13.0	12.0	18.0	15.0	900	720,000	135	10	11	5.68	45	76MI3150(1)H7(2)	R76MI3150(1)H7(2)
400	250	0.1800	10.0	16.0	18.0	15.0	900	720,000	162	10	9	6.28	44	76MI3180(1)H3(2)	R76MI3180(1)H3(2)
400	250	0.1800	13.0	12.0	18.0	15.0	900	720,000	162	10	9	6.22	45	76MI3180(1)H7(2)	R76MI3180(1)H7(2)
400	250	0.2200	10.0	16.0	18.0	15.0	900	720,000	198	10	7	6.94	44	76MI3220(1)H3(2)	R76MI3220(1)H3(2)
400	250	0.2700	11.0	19.0	18.0	15.0	900	720,000	243	10	6	8.05	40	76MI3270(1)H3(2)	R76MI3270(1)H3(2)
400	250	0.1200	6.0	15.0	26.5	22.5	500	400,000	60	16	13	5.17	43	76MN3120(1)H3(2)	R76MN3120(1)H3(2)
400	250	0.1500	6.0	15.0	26.5	22.5	500	400,000	75	16	11	5.78	43	76MN3150(1)H3(2)	R76MN3150(1)H3(2)
400	250	0.1800	6.0	15.0	26.5	22.5	500	400,000	90	16	9	6.33	43	76MN3180(1)H3(2)	R76MN3180(1)H3(2)
400	250	0.2200	7.0	16.0	26.5	22.5	500	400,000	110	16	7	7.20	41	76MN3220(1)H3(2)	R76MN3220(1)H3(2)
400	250	0.2700	8.5	17.0	26.5	22.5	500	400,000	135	16	6	8.24	38	76MN3270(1)H3(2)	R76MN3270(1)H3(2)
400	250	0.3300	8.5	17.0	26.5	22.5	500	400,000	165	16	5	9.11	38	76MN3330(1)H3(2)	R76MN3330(1)H3(2)
400	250	0.3900	10.0	18.5	26.5	22.5	500	400,000	195	16	4	10.26	36	76MN3390(1)H3(2)	R76MN3390(1)H3(2)
400	250	0.4700	10.0	18.5	26.5	22.5	500	400,000	235	16	3	11.26	36	76MN3470(1)H3(2)	R76MN3470(1)H3(2)
400	250	0.5600	11.0	20.0	26.5	22.5	500	400,000	280	16	3	12.62	34	76MN3560(1)H3(2)	R76MN3560(1)H3(2)
400	250	0.6800	13.0	22.0	26.5	22.5	500	400,000	340	16	2	14.47	31	76MN3680(1)H3(2)	R76MN3680(1)H3(2)
400	250	0.5600	11.0	20.0	32.0	27.5	300	240,000	168	18	11	6.56	31	76MR3560(1)H3(2)	R76MR3560(1)H3(2)
400	250	0.6800	11.0	20.0	32.0	27.5	300	240,000	204	18	11	6.82	31	76MR3680(1)H3(2)	R76MR3680(1)H3(2)
400	250	0.8200	13.0	22.0	32.0	27.5	300	240,000	246	18	9	7.78	29	76MR3820(1)H3(2)	R76MR3820(1)H3(2)
400	250	1.0000	13.0	22.0	32.0	27.5	300	240,000	300	18	7	8.59	29	76MR4100(1)H4(2)	R76MR4100(1)H4(2)
400	250	1.2000	14.0	28.0	32.0	27.5	300	240,000	360	18	16	6.09	26	76MR4120(1)H4(2)	R76MR4120(1)H4(2)
400	250	1.5000	18.0	33.0	32.0	27.5	300	240,000	450	18	13	7.26	23	76MR4150(1)H3(2)	R76MR4150(1)H3(2)
400	250	1.8000	18.0	33.0	32.0	27.5	300	240,000	540	18	11	7.95	23	76MR4180(1)H3(2)	R76MR4180(1)H3(2)

(1) Insert lead and packaging code. See Ordering Options Table for available options.

(2) H = 2.5% (only for C ≥ 1,000 pF), J = 5%, K = 10%

(*) I_{rms} value that leads to a ΔT of ≈ 15°C in the hot spot > T_{HS} = T_{AMB} + ΔT = 100°C + 15°C = 115°C

Table 1 – Ratings & Part Number Reference cont.

VDC	VAC	Cap Value (μF)	Dimensions in mm			Lead Spacing (S)	dV/dt (V/μs)	Max K ₀ (V ² /μs)	I _{pk}	ESL	ESR	I _{rms} max (*)	R _{th}	KEMET Internal Part Number	Customer Part Number
			Lead Length 2x 4 mm	at 100 kHz	at 100 kHz, 100°C					(°C/W)					
											A _{pk}	nH	mΩ		
T	H	L	Lead Spacing (S)	dV/dt (V/μs)	Max K ₀ (V ² /μs)	A _{pk}	Lead Length 2x 4 mm	at 100 kHz	I _{rms} max (*)	R _{th}	KEMET Internal Part Number	Customer Part Number			
400	250	2.2000	22.0	37.0	32.0	27.5	300	240,000	660	18	9	9.24	21	76MR4220(1)H3(2)	R76MR4220(1)H3(2)
400	250	2.7000	22.0	37.0	32.0	27.5	300	240,000	810	18	7	10.23	21	76MR4270(1)H3(2)	R76MR4270(1)H3(2)
400	250	1.0000	11.0	22.0	41.5	37.5	180	144,000	180	20	7	8.90	27	76MW4100(1)H3(2)	R76MW4100(1)H3(2)
400	250	1.0000	24.0	15.0	41.5	37.5	180	144,000	180	20	7	9.38	24	76MW4100(1)HL(2)	R76MW4100(1)HL(2)
400	250	1.2000	13.0	24.0	41.5	37.5	180	144,000	216	20	16	6.19	25	76MW4120(1)H3(2)	R76MW4120(1)H3(2)
400	250	1.2000	24.0	15.0	41.5	37.5	180	144,000	216	20	16	6.30	24	76MW4120(1)HL(2)	R76MW4120(1)HL(2)
400	250	1.5000	13.0	24.0	41.5	37.5	180	144,000	270	20	13	6.92	25	76MW4150(1)H3(2)	R76MW4150(1)H3(2)
400	250	1.5000	24.0	15.0	41.5	37.5	180	144,000	270	20	13	7.04	24	76MW4150(1)HL(2)	R76MW4150(1)HL(2)
400	250	1.8000	16.0	28.5	41.5	37.5	180	144,000	324	20	11	8.02	23	76MW4180(1)H3(2)	R76MW4180(1)H3(2)
400	250	1.8000	24.0	19.0	41.5	37.5	180	144,000	324	20	11	7.96	23	76MW4180(1)HL(2)	R76MW4180(1)HL(2)
400	250	2.2000	19.0	32.0	41.5	37.5	180	144,000	396	20	9	9.26	21	76MW4220(1)H3(2)	R76MW4220(1)H3(2)
400	250	2.2000	24.0	19.0	41.5	37.5	180	144,000	396	20	9	8.80	23	76MW4220(1)HL(2)	R76MW4220(1)HL(2)
400	250	2.7000	19.0	32.0	41.5	37.5	180	144,000	486	20	7	10.26	21	76MW4270(1)H3(2)	R76MW4270(1)H3(2)
400	250	3.3000	19.0	32.0	41.5	37.5	180	144,000	594	20	6	11.34	21	76MW4330(1)H3(2)	R76MW4330(1)H3(2)
400	250	3.9000	20.0	40.0	41.5	37.5	180	144,000	702	20	5	12.94	19	76MW4390(1)H3(2)	R76MW4390(1)H3(2)
400	250	4.7000	20.0	40.0	41.5	37.5	180	144,000	846	20	4	14.21	19	76MW4470(1)H3(2)	R76MW4470(1)H3(2)
400	250	5.6000	24.0	44.0	41.5	37.5	180	144,000	1,008	20	3	16.18	17	76MW4560(1)H3(2)	R76MW4560(1)H3(2)
400	250	6.8000	30.0	45.0	41.5	37.5	180	144,000	1,224	20	3	18.49	16	76MW4680(1)H3(2)	R76MW4680(1)H3(2)
400	250	8.2000	30.0	45.0	41.5	37.5	180	144,000	1,476	20	2	20.30	16	76MW4820(1)H3(2)	R76MW4820(1)H3(2)
630	400	0.0039	4.0	9.0	13.0	10.0	4,000	5,040,000	16	9	163	0.98	79	76PF1390(1)H0(2)	R76PF1390(1)H0(2)
630	400	0.0047	4.0	9.0	13.0	10.0	4,000	5,040,000	19	9	135	1.18	79	76PF1470(1)H0(2)	R76PF1470(1)H0(2)
630	400	0.0056	4.0	9.0	13.0	10.0	4,000	5,040,000	22	9	114	1.31	79	76PF1560(1)H0(2)	R76PF1560(1)H0(2)
630	400	0.0068	4.0	9.0	13.0	10.0	4,000	5,040,000	27	9	94	1.45	79	76PF1680(1)H0(2)	R76PF1680(1)H0(2)
630	400	0.0082	4.0	9.0	13.0	10.0	4,000	5,040,000	33	9	78	1.59	79	76PF1820(1)H0(2)	R76PF1820(1)H0(2)
630	400	0.0100	5.0	11.0	13.0	10.0	4,000	5,040,000	40	9	64	1.87	69	76PF2100(1)H3(2)	R76PF2100(1)H3(2)
630	400	0.0120	5.0	11.0	13.0	10.0	4,000	5,040,000	48	9	53	2.05	69	76PF2120(1)H3(2)	R76PF2120(1)H3(2)
630	400	0.0150	6.0	12.0	13.0	10.0	4,000	5,040,000	60	9	42	2.38	64	76PF2150(1)H3(2)	R76PF2150(1)H3(2)
630	400	0.0180	6.0	12.0	13.0	10.0	4,000	5,040,000	72	9	35	2.61	64	76PF2180(1)H3(2)	R76PF2180(1)H3(2)
630	400	0.0120	5.0	11.0	18.0	15.0	3,000	3,780,000	36	10	53	2.19	60	76PI2120(1)H0(2)	R76PI2120(1)H0(2)
630	400	0.0150	5.0	11.0	18.0	15.0	3,000	3,780,000	45	10	42	2.45	60	76PI2150(1)H0(2)	R76PI2150(1)H0(2)
630	400	0.0180	5.0	11.0	18.0	15.0	3,000	3,780,000	54	10	35	2.69	60	76PI2180(1)H0(2)	R76PI2180(1)H0(2)
630	400	0.0220	5.0	11.0	18.0	15.0	3,000	3,780,000	66	10	29	2.97	60	76PI2220(1)H3(2)	R76PI2220(1)H3(2)
630	400	0.0270	5.0	11.0	18.0	15.0	3,000	3,780,000	81	10	24	3.29	60	76PI2270(1)H3(2)	R76PI2270(1)H3(2)
630	400	0.0330	6.0	12.0	18.0	15.0	3,000	3,780,000	99	10	19	3.78	56	76PI2330(1)H3(2)	R76PI2330(1)H3(2)
630	400	0.0390	6.0	12.0	18.0	15.0	3,000	3,780,000	117	10	16	4.10	56	76PI2390(1)H3(2)	R76PI2390(1)H3(2)
630	400	0.0470	7.5	13.5	18.0	15.0	3,000	3,780,000	141	10	14	4.73	51	76PI2470(1)H3(2)	R76PI2470(1)H3(2)
630	400	0.0470	9.0	12.5	18.0	15.0	3,000	3,780,000	141	10	14	4.78	50	76PI2470(1)H7(2)	R76PI2470(1)H7(2)
630	400	0.0560	7.5	13.5	18.0	15.0	3,000	3,780,000	168	10	23	3.65	51	76PI2560(1)H3(2)	R76PI2560(1)H3(2)
630	400	0.0560	9.0	12.5	18.0	15.0	3,000	3,780,000	168	10	23	3.69	50	76PI2560(1)H7(2)	R76PI2560(1)H7(2)
630	400	0.0680	8.5	14.5	18.0	15.0	3,000	3,780,000	204	10	19	4.15	48	76PI2680(1)H3(2)	R76PI2680(1)H3(2)
630	400	0.0680	9.0	12.5	18.0	15.0	3,000	3,780,000	204	10	19	4.07	50	76PI2680(1)H7(2)	R76PI2680(1)H7(2)
630	400	0.0820	8.5	14.5	18.0	15.0	3,000	3,780,000	246	10	16	4.55	48	76PI2820(1)H3(2)	R76PI2820(1)H3(2)
630	400	0.0820	13.0	12.0	18.0	15.0	3,000	3,780,000	246	10	16	4.70	45	76PI2820(1)H7(2)	R76PI2820(1)H7(2)
630	400	0.1000	10.0	16.0	18.0	15.0	3,000	3,780,000	300	10	13	5.23	44	76PI3100(1)H3(2)	R76PI3100(1)H3(2)
630	400	0.1200	11.0	19.0	18.0	15.0	3,000	3,780,000	360	10	13	5.37	40	76PI3120(1)H3(2)	R76PI3120(1)H3(2)
630	400	0.0470	6.0	15.0	26.5	22.5	1,500	1,890,000	71	16	14	5.11	43	76PN2470(1)H0(2)	R76PN2470(1)H0(2)
630	400	0.0560	6.0	15.0	26.5	22.5	1,500	1,890,000	84	16	23	3.95	43	76PN2560(1)H0(2)	R76PN2560(1)H0(2)
630	400	0.0680	6.0	15.0	26.5	22.5	1,500	1,890,000	102	16	19	4.35	43	76PN2680(1)H0(2)	R76PN2680(1)H0(2)
630	400	0.0820	6.0	15.0	26.5	22.5	1,500	1,890,000	123	16	16	4.78	43	76PN2820(1)H3(2)	R76PN2820(1)H3(2)
630	400	0.1000	6.0	15.0	26.5	22.5	1,500	1,890,000	150	16	13	5.27	43	76PN3100(1)H3(2)	R76PN3100(1)H3(2)
630	400	0.1200	7.0	16.0	26.5	22.5	1,500	1,890,000	180	16	13	5.32	41	76PN3120(1)H3(2)	R76PN3120(1)H3(2)
VDC	VAC	Cap Value	T	H	L	Lead Spacing (S)	dV/dt (V/μs)	Max K ₀ (V ² /μs)	A _{pk}	Lead Length 2x 4 mm	at 100 kHz	at 100 kHz, 100°C	(°C/W)	KEMET Internal Part Number	Customer Part Number
									I _{pk}	ESL	ESR	I _{rms} max (*)	R _{th}		

(1) Insert lead and packaging code. See Ordering Options Table for available options.

(2) H = 2.5% (only for C ≥ 1,000 pF), J = 5%, K = 10%

(*) I_{rms} value that leads to a ΔT of ≈ 15°C in the hot spot > T_{HS} = T_{AMB} + ΔT = 100°C + 15°C = 115°C

Table 1 – Ratings & Part Number Reference cont.

VDC	VAC	Cap Value (μF)	Dimensions in mm			Lead Spacing (S)	dV/dt (V/μs)	Max K ₀ (V ² /μs)	I _{pk}	ESL	ESR	I _{rms} max (*)	Rth	KEMET Internal Part Number	Customer Part Number
										Lead Length 2x 4 mm	at 100 kHz	at 100 kHz, 100°C	(°C/W)		
			A _{pk}	nH	mΩ				A _{rms}	(°C/W)					
630	400	0.1500	8.5	17.0	26.5	22.5	1,500	1,890,000	225	16	11	6.14	38	76PN3150(1)H3(2)	R76PN3150(1)H3(2)
630	400	0.1800	8.5	17.0	26.5	22.5	1,500	1,890,000	270	16	9	6.73	38	76PN3180(1)H3(2)	R76PN3180(1)H3(2)
630	400	0.2200	10.0	18.5	26.5	22.5	1,500	1,890,000	330	16	7	7.71	36	76PN3220(1)H3(2)	R76PN3220(1)H3(2)
630	400	0.2700	11.0	20.0	26.5	22.5	1,500	1,890,000	405	16	6	8.77	34	76PN3270(1)H3(2)	R76PN3270(1)H3(2)
630	400	0.3300	11.0	20.0	26.5	22.5	1,500	1,890,000	495	16	5	9.69	34	76PN3330(1)H3(2)	R76PN3330(1)H3(2)
630	400	0.3900	13.0	22.0	26.5	22.5	1,500	1,890,000	585	16	4	10.96	31	76PN3390(1)H3(2)	R76PN3390(1)H3(2)
630	400	0.3300	11.0	20.0	32.0	27.5	900	1,134,000	297	18	12	6.37	31	76PR3330(1)H4(2)	R76PR3330(1)H4(2)
630	400	0.3900	11.0	20.0	32.0	27.5	900	1,134,000	351	18	16	5.48	31	76PR3390(1)H3(2)	R76PR3390(1)H3(2)
630	400	0.4700	13.0	22.0	32.0	27.5	900	1,134,000	423	18	14	6.25	29	76PR3470(1)H3(2)	R76PR3470(1)H3(2)
630	400	0.5600	13.0	22.0	32.0	27.5	900	1,134,000	504	18	11	6.82	29	76PR3560(1)H3(2)	R76PR3560(1)H3(2)
630	400	0.6800	13.0	25.0	32.0	27.5	900	1,134,000	612	18	11	7.26	28	76PR3680(1)H4(2)	R76PR3680(1)H4(2)
630	400	0.8200	14.0	28.0	32.0	27.5	900	1,134,000	738	18	9	8.22	26	76PR3820(1)H3(2)	R76PR3820(1)H3(2)
630	400	1.0000	18.0	33.0	32.0	27.5	900	1,134,000	900	18	7	9.67	23	76PR4100(1)H3(2)	R76PR4100(1)H3(2)
630	400	1.2000	18.0	33.0	32.0	27.5	900	1,134,000	1,080	18	16	6.49	23	76PR4120(1)H3(2)	R76PR4120(1)H3(2)
630	400	1.5000	22.0	37.0	32.0	27.5	900	1,134,000	1,350	18	13	7.63	21	76PR4150(1)H3(2)	R76PR4150(1)H3(2)
630	400	1.8000	22.0	37.0	32.0	27.5	900	1,134,000	1,620	18	11	8.36	21	76PR4180(1)H3(2)	R76PR4180(1)H3(2)
630	400	0.3300	11.0	22.0	41.5	37.5	450	567,000	149	20	12	6.86	27	76PW3330(1)H3(2)	R76PW3330(1)H3(2)
630	400	0.3900	11.0	22.0	41.5	37.5	450	567,000	176	20	16	5.90	27	76PW3390(1)H3(2)	R76PW3390(1)H3(2)
630	400	0.4700	11.0	22.0	41.5	37.5	450	567,000	212	20	14	6.47	27	76PW3470(1)H3(2)	R76PW3470(1)H3(2)
630	400	0.5600	11.0	22.0	41.5	37.5	450	567,000	252	20	11	7.06	27	76PW3560(1)H3(2)	R76PW3560(1)H3(2)
630	400	0.6800	11.0	22.0	41.5	37.5	450	567,000	306	20	11	7.34	27	76PW3680(1)H3(2)	R76PW3680(1)H3(2)
630	400	0.6800	24.0	15.0	41.5	37.5	450	567,000	306	20	11	7.74	24	76PW3680(1)HL(2)	R76PW3680(1)HL(2)
630	400	0.8200	13.0	24.0	41.5	37.5	450	567,000	369	20	9	8.35	25	76PW3820(1)H3(2)	R76PW3820(1)H3(2)
630	400	0.8200	24.0	15.0	41.5	37.5	450	567,000	369	20	9	8.50	24	76PW3820(1)HL(2)	R76PW3820(1)HL(2)
630	400	1.0000	16.0	28.5	41.5	37.5	450	567,000	450	20	7	9.76	23	76PW4100(1)H3(2)	R76PW4100(1)H3(2)
630	400	1.0000	24.0	15.0	41.5	37.5	450	567,000	450	20	7	9.38	24	76PW4100(1)HL(2)	R76PW4100(1)HL(2)
630	400	1.2000	16.0	28.5	41.5	37.5	450	567,000	540	20	16	6.55	23	76PW4120(1)H3(2)	R76PW4120(1)H3(2)
630	400	1.2000	24.0	19.0	41.5	37.5	450	567,000	540	20	16	6.50	23	76PW4120(1)HL(2)	R76PW4120(1)HL(2)
630	400	1.5000	16.0	28.5	41.5	37.5	450	567,000	675	20	13	7.32	23	76PW4150(1)H3(2)	R76PW4150(1)H3(2)
630	400	1.5000	24.0	19.0	41.5	37.5	450	567,000	675	20	13	7.27	23	76PW4150(1)HL(2)	R76PW4150(1)HL(2)
630	400	1.8000	19.0	32.0	41.5	37.5	450	567,000	810	20	11	8.37	21	76PW4180(1)H3(2)	R76PW4180(1)H3(2)
630	400	2.2000	20.0	40.0	41.5	37.5	450	567,000	990	20	9	9.72	19	76PW4220(1)H3(2)	R76PW4220(1)H3(2)
630	400	2.7000	20.0	40.0	41.5	37.5	450	567,000	1,215	20	7	10.77	19	76PW4270(1)H3(2)	R76PW4270(1)H3(2)
630	400	3.3000	24.0	44.0	41.5	37.5	450	567,000	1,485	20	6	12.42	17	76PW4330(1)H3(2)	R76PW4330(1)H3(2)
630	400	3.9000	30.0	45.0	41.5	37.5	450	567,000	1,755	20	5	14.00	16	76PW4390(1)H3(2)	R76PW4390(1)H3(2)
1000	600	0.00047	4.0	9.0	13.0	10.0	6,500	13,000,000	3	9	1,355	0.18	79	76QF0470(1)H0(2)	R76QF0470(1)H0(2)
1000	600	0.00056	4.0	9.0	13.0	10.0	6,500	13,000,000	4	9	1,137	0.21	79	76QF0560(1)H0(2)	R76QF0560(1)H0(2)
1000	600	0.00068	4.0	9.0	13.0	10.0	6,500	13,000,000	4	9	936	0.26	79	76QF0680(1)H0(2)	R76QF0680(1)H0(2)
1000	600	0.00082	4.0	9.0	13.0	10.0	6,500	13,000,000	5	9	776	0.31	79	76QF0820(1)H0(2)	R76QF0820(1)H0(2)
1000	600	0.0010	4.0	9.0	13.0	10.0	6,500	13,000,000	7	9	637	0.38	79	76QF1100(1)H0(2)	R76QF1100(1)H0(2)
1000	600	0.0012	4.0	9.0	13.0	10.0	6,500	13,000,000	8	9	531	0.45	79	76QF1120(1)H0(2)	R76QF1120(1)H0(2)
1000	600	0.0015	4.0	9.0	13.0	10.0	6,500	13,000,000	10	9	424	0.57	79	76QF1150(1)H0(2)	R76QF1150(1)H0(2)
1000	600	0.0018	4.0	9.0	13.0	10.0	6,500	13,000,000	12	9	354	0.68	79	76QF1180(1)H0(2)	R76QF1180(1)H0(2)
1000	600	0.0022	4.0	9.0	13.0	10.0	6,500	13,000,000	14	9	289	0.82	79	76QF1220(1)H0(2)	R76QF1220(1)H0(2)
1000	600	0.0027	4.0	9.0	13.0	10.0	6,500	13,000,000	18	9	236	0.91	79	76QF1270(1)H0(2)	R76QF1270(1)H0(2)
1000	600	0.0033	4.0	9.0	13.0	10.0	6,500	13,000,000	21	9	193	1.01	79	76QF1330(1)H3(2)	R76QF1330(1)H3(2)
1000	600	0.0039	5.0	11.0	13.0	10.0	6,500	13,000,000	25	9	163	1.17	69	76QF1390(1)H3(2)	R76QF1390(1)H3(2)
1000	600	0.0047	5.0	11.0	13.0	10.0	6,500	13,000,000	31	9	135	1.28	69	76QF1470(1)H3(2)	R76QF1470(1)H3(2)
1000	600	0.0056	6.0	12.0	13.0	10.0	6,500	13,000,000	36	9	114	1.46	64	76QF1560(1)H3(2)	R76QF1560(1)H3(2)
1000	600	0.0068	6.0	12.0	13.0	10.0	6,500	13,000,000	44	9	94	1.60	64	76QF1680(1)H3(2)	R76QF1680(1)H3(2)
1000	600	0.0082	4.0	10.0	18.0	15.0	3,500	7,000,000	29	10	78	1.74	65	76QI1820(1)H4(2)	R76QI1820(1)H4(2)
VDC	VAC	Cap Value	T	H	L	Lead Spacing (S)	dV/dt (V/μs)	Max K ₀ (V ² /μs)	A _{pk}	Lead Length 2x 4 mm	at 100 kHz	at 100 kHz, 100°C	(°C/W)	KEMET Internal Part Number	Customer Part Number
									I _{pk}	ESL	ESR	I _{rms} max (*)	R _{th}		

(1) Insert lead and packaging code. See Ordering Options Table for available options.

(2) H = 2.5% (only for C ≥ 1,000 pF), J = 5%, K = 10%

(*) I_{rms} value that leads to a ΔT of ≈ 15°C in the hot spot > T_{HS} = T_{AMB} + ΔT = 100°C + 15°C = 115°C

Table 1 – Ratings & Part Number Reference cont.

VDC	VAC	Cap Value (µF)	Dimensions in mm			Lead Spacing (S)	dV/dt (V/µs)	Max K ₀ (V ² /µs)	I _{pk}	ESL	ESR	I _{rms} max (*)	Rth	KEMET Internal Part Number	Customer Part Number
			T	H	L										
1000	600	0.0082	5.0	11.0	18.0	15.0	3,500	7,000,000	29	10	78	1.81	60	76QI1820(1)H0(2)	R76QI1820(1)H0(2)
1000	600	0.0100	4.0	10.0	18.0	15.0	3,500	7,000,000	35	10	64	1.92	65	76QI2100(1)H4(2)	R76QI2100(1)H4(2)
1000	600	0.0100	5.0	11.0	18.0	15.0	3,500	7,000,000	35	10	64	2.00	60	76QI2100(1)H3(2)	R76QI2100(1)H3(2)
1000	600	0.0120	5.0	11.0	18.0	15.0	3,500	7,000,000	42	10	53	2.19	60	76QI2120(1)H3(2)	R76QI2120(1)H3(2)
1000	600	0.0150	5.0	11.0	18.0	15.0	3,500	7,000,000	53	10	42	2.45	60	76QI2150(1)H4(2)	R76QI2150(1)H4(2)
1000	600	0.0180	5.0	11.0	18.0	15.0	3,500	7,000,000	63	10	35	2.69	60	76QI2180(1)H4(2)	R76QI2180(1)H4(2)
1000	600	0.0220	6.0	12.0	18.0	15.0	3,500	7,000,000	77	10	29	3.08	56	76QI2220(1)H4(2)	R76QI2220(1)H4(2)
1000	600	0.0220	9.0	12.5	18.0	15.0	3,500	7,000,000	77	10	29	3.27	50	76QI2220(1)H7(2)	R76QI2220(1)H7(2)
1000	600	0.0270	7.5	13.5	18.0	15.0	3,500	7,000,000	95	10	24	3.59	51	76QI2270(1)H4(2)	R76QI2270(1)H4(2)
1000	600	0.0270	9.0	12.5	18.0	15.0	3,500	7,000,000	95	10	24	3.63	50	76QI2270(1)H7(2)	R76QI2270(1)H7(2)
1000	600	0.0330	7.5	13.5	18.0	15.0	3,500	7,000,000	116	10	19	3.97	51	76QI2330(1)H4(2)	R76QI2330(1)H4(2)
1000	600	0.0330	13.0	12.0	18.0	15.0	3,500	7,000,000	116	10	19	4.21	45	76QI2330(1)H7(2)	R76QI2330(1)H7(2)
1000	600	0.0390	8.5	14.5	18.0	15.0	3,500	7,000,000	137	10	16	4.44	48	76QI2390(1)H4(2)	R76QI2390(1)H4(2)
1000	600	0.0470	8.5	14.5	18.0	15.0	3,500	7,000,000	165	10	14	4.88	48	76QI2470(1)H4(2)	R76QI2470(1)H4(2)
1000	600	0.0270	6.0	15.0	26.5	22.5	2,100	4,200,000	57	16	24	3.88	43	76QN2270(1)H0(2)	R76QN2270(1)H0(2)
1000	600	0.0330	6.0	15.0	26.5	22.5	2,100	4,200,000	69	16	19	4.28	43	76QN2330(1)H3(2)	R76QN2330(1)H3(2)
1000	600	0.0390	6.0	15.0	26.5	22.5	2,100	4,200,000	82	16	16	4.66	43	76QN2390(1)H3(2)	R76QN2390(1)H3(2)
1000	600	0.0470	7.0	16.0	26.5	22.5	2,100	4,200,000	99	16	14	5.26	41	76QN2470(1)H3(2)	R76QN2470(1)H3(2)
1000	600	0.0560	7.0	16.0	26.5	22.5	2,100	4,200,000	118	16	23	4.06	41	76QN2560(1)H3(2)	R76QN2560(1)H3(2)
1000	600	0.0680	8.5	17.0	26.5	22.5	2,100	4,200,000	143	16	19	4.62	38	76QN2680(1)H3(2)	R76QN2680(1)H3(2)
1000	600	0.0820	10.0	18.5	26.5	22.5	2,100	4,200,000	172	16	16	5.26	36	76QN2820(1)H3(2)	R76QN2820(1)H3(2)
1000	600	0.1000	10.0	18.5	26.5	22.5	2,100	4,200,000	210	16	13	5.81	36	76QN3100(1)H3(2)	R76QN3100(1)H3(2)
1000	600	0.1200	11.0	20.0	26.5	22.5	2,100	4,200,000	252	16	13	5.84	34	76QN3120(1)H3(2)	R76QN3120(1)H3(2)
1000	600	0.1500	13.0	22.0	26.5	22.5	2,100	4,200,000	315	16	11	6.80	31	76QN3150(1)H3(2)	R76QN3150(1)H3(2)
1000	600	0.1500	11.0	20.0	32.0	27.5	1,000	2,000,000	150	18	21	4.80	31	76QR3150(1)H3(2)	R76QR3150(1)H3(2)
1000	600	0.1800	13.0	22.0	32.0	27.5	1,000	2,000,000	180	18	18	5.47	29	76QR3180(1)H3(2)	R76QR3180(1)H3(2)
1000	600	0.2200	13.0	22.0	32.0	27.5	1,000	2,000,000	220	18	14	6.05	29	76QR3220(1)H3(2)	R76QR3220(1)H3(2)
1000	600	0.2700	13.0	25.0	32.0	27.5	1,000	2,000,000	270	18	15	6.13	28	76QR3270(1)H4(2)	R76QR3270(1)H4(2)
1000	600	0.3300	14.0	28.0	32.0	27.5	1,000	2,000,000	330	18	12	6.99	26	76QR3330(1)H3(2)	R76QR3330(1)H3(2)
1000	600	0.3900	18.0	33.0	32.0	27.5	1,000	2,000,000	390	18	16	6.41	23	76QR3390(1)H3(2)	R76QR3390(1)H3(2)
1000	600	0.4700	18.0	33.0	32.0	27.5	1,000	2,000,000	470	18	14	7.03	23	76QR3470(1)H3(2)	R76QR3470(1)H3(2)
1000	600	0.5600	22.0	37.0	32.0	27.5	1,000	2,000,000	560	18	11	8.07	21	76QR3560(1)H3(2)	R76QR3560(1)H3(2)
1000	600	0.6800	22.0	37.0	32.0	27.5	1,000	2,000,000	680	18	11	8.39	21	76QR3680(1)H3(2)	R76QR3680(1)H3(2)
1000	600	0.1800	11.0	22.0	41.5	37.5	500	1,000,000	90	20	18	5.66	27	76QW3180(1)H3(2)	R76QW3180(1)H3(2)
1000	600	0.2200	11.0	22.0	41.5	37.5	500	1,000,000	110	20	14	6.26	27	76QW3220(1)H3(2)	R76QW3220(1)H3(2)
1000	600	0.2700	13.0	24.0	41.5	37.5	500	1,000,000	135	20	15	6.43	25	76QW3270(1)H3(2)	R76QW3270(1)H3(2)
1000	600	0.2700	24.0	15.0	41.5	37.5	500	1,000,000	135	20	15	6.54	24	76QW3270(1)HL(2)	R76QW3270(1)HL(2)
1000	600	0.3300	13.0	24.0	41.5	37.5	500	1,000,000	165	20	12	7.11	25	76QW3330(1)H3(2)	R76QW3330(1)H3(2)
1000	600	0.3300	24.0	15.0	41.5	37.5	500	1,000,000	165	20	12	7.23	24	76QW3330(1)HL(2)	R76QW3330(1)HL(2)
1000	600	0.3900	16.0	28.5	41.5	37.5	500	1,000,000	195	20	16	6.46	23	76QW3390(1)H3(2)	R76QW3390(1)H3(2)
1000	600	0.3900	24.0	15.0	41.5	37.5	500	1,000,000	195	20	16	6.22	24	76QW3390(1)HL(2)	R76QW3390(1)HL(2)
1000	600	0.4700	16.0	28.5	41.5	37.5	500	1,000,000	235	20	14	7.10	23	76QW3470(1)H3(2)	R76QW3470(1)H3(2)
1000	600	0.4700	24.0	19.0	41.5	37.5	500	1,000,000	235	20	14	7.05	23	76QW3470(1)HL(2)	R76QW3470(1)HL(2)
1000	600	0.5600	16.0	28.5	41.5	37.5	500	1,000,000	280	20	11	7.75	23	76QW3560(1)H3(2)	R76QW3560(1)H3(2)
1000	600	0.5600	24.0	19.0	41.5	37.5	500	1,000,000	280	20	11	7.69	23	76QW3560(1)HL(2)	R76QW3560(1)HL(2)
1000	600	0.6800	19.0	32.0	41.5	37.5	500	1,000,000	340	20	11	8.40	21	76QW3680(1)H3(2)	R76QW3680(1)H3(2)
1000	600	0.8200	20.0	40.0	41.5	37.5	500	1,000,000	410	20	9	9.69	19	76QW3820(1)H3(2)	R76QW3820(1)H3(2)
1000	600	1.0000	20.0	40.0	41.5	37.5	500	1,000,000	500	20	7	10.70	19	76QW4100(1)H3(2)	R76QW4100(1)H3(2)
1000	600	1.2000	24.0	44.0	41.5	37.5	500	1,000,000	600	20	16	7.49	17	76QW4120(1)H3(2)	R76QW4120(1)H3(2)
1000	600	1.5000	24.0	44.0	41.5	37.5	500	1,000,000	750	20	13	8.37	17	76QW4150(1)H3(2)	R76QW4150(1)H3(2)
1000	600	2.2000	24.0	44.0	41.5	37.5	500	1,000,000	1,100	20	9	10.14	17	76QW4220(1)H3(2)	R76QW4220(1)H3(2)

(1) Insert lead and packaging code. See Ordering Options Table for available options.
 (2) H = 2.5% (only for C ≥ 1,000 pF), J = 5%, K = 10%
 (*) I_{rms} value that leads to a ΔT of ≈ 15°C in the hot spot > T_{HS} = T_{AMB} + ΔT = 100°C + 15°C = 115°C

Table 1 – Ratings & Part Number Reference cont.

VDC	VAC	Cap Value (µF)	Dimensions in mm			Lead Spacing (S)	dV/dt (V/µs)	Max K ₀ (V ² /µs)	I _{pk}	ESL	ESR	I _{rms} max (*)	R _{th}	KEMET Internal Part Number	Customer Part Number
			Lead Length 2x 4 mm	at 100 kHz	at 100 kHz, 100°C					R _{th}					
											A _{pk}	nH	mΩ		
T	H	L													
1600	650	0.0033	4.0	10.0	18.0	15.0	6,000	19,200,000	20	10	193	1.10	65	76T11330(1)H4(2)	R76T11330(1)H4(2)
1600	650	0.0033	5.0	11.0	18.0	15.0	6,000	19,200,000	20	10	193	1.15	60	76T11330(1)H3(2)	R76T11330(1)H3(2)
1600	650	0.0039	4.0	10.0	18.0	15.0	6,000	19,200,000	23	10	163	1.20	65	76T11390(1)H4(2)	R76T11390(1)H4(2)
1600	650	0.0039	5.0	11.0	18.0	15.0	6,000	19,200,000	23	10	163	1.25	60	76T11390(1)H3(2)	R76T11390(1)H3(2)
1600	650	0.0047	4.0	10.0	18.0	15.0	6,000	19,200,000	28	10	135	1.32	65	76T11470(1)H4(2)	R76T11470(1)H4(2)
1600	650	0.0047	5.0	11.0	18.0	15.0	6,000	19,200,000	28	10	135	1.37	60	76T11470(1)H3(2)	R76T11470(1)H3(2)
1600	650	0.0056	4.0	10.0	18.0	15.0	6,000	19,200,000	34	10	114	1.44	65	76T11560(1)H4(2)	R76T11560(1)H4(2)
1600	650	0.0056	5.0	11.0	18.0	15.0	6,000	19,200,000	34	10	114	1.50	60	76T11560(1)H3(2)	R76T11560(1)H3(2)
1600	650	0.0068	5.0	11.0	18.0	15.0	6,000	19,200,000	41	10	94	1.65	60	76T11680(1)H3(2)	R76T11680(1)H3(2)
1600	650	0.0082	5.0	11.0	18.0	15.0	6,000	19,200,000	49	10	78	1.81	60	76T11820(1)H4(2)	R76T11820(1)H4(2)
1600	650	0.0100	5.0	11.0	18.0	15.0	6,000	19,200,000	60	10	64	2.00	60	76T12100(1)H4(2)	R76T12100(1)H4(2)
1600	650	0.0120	6.0	12.0	18.0	15.0	6,000	19,200,000	72	10	53	2.28	56	76T12120(1)H4(2)	R76T12120(1)H4(2)
1600	650	0.0150	6.0	12.0	18.0	15.0	6,000	19,200,000	90	10	42	2.55	56	76T12150(1)H4(2)	R76T12150(1)H4(2)
1600	650	0.0180	7.5	13.5	18.0	15.0	6,000	19,200,000	108	10	35	2.93	51	76T12180(1)H4(2)	R76T12180(1)H4(2)
1600	650	0.0180	9.0	12.5	18.0	15.0	6,000	19,200,000	108	10	35	2.96	50	76T12180(1)H7(2)	R76T12180(1)H7(2)
1600	650	0.0220	7.5	13.5	18.0	15.0	6,000	19,200,000	132	10	29	3.24	51	76T12220(1)H4(2)	R76T12220(1)H4(2)
1600	650	0.0220	13.0	12.0	18.0	15.0	6,000	19,200,000	132	10	29	3.44	45	76T12220(1)H7(2)	R76T12220(1)H7(2)
1600	650	0.0270	8.5	14.5	18.0	15.0	6,000	19,200,000	162	10	24	3.69	48	76T12270(1)H4(2)	R76T12270(1)H4(2)
1600	650	0.0330	8.5	14.5	18.0	15.0	6,000	19,200,000	198	10	19	4.08	48	76T12330(1)H4(2)	R76T12330(1)H4(2)
1600	650	0.0150	6.0	15.0	26.5	22.5	3,000	9,600,000	45	16	42	2.89	43	76TN2150(1)H3(2)	R76TN2150(1)H3(2)
1600	650	0.0180	6.0	15.0	26.5	22.5	3,000	9,600,000	54	16	35	3.16	43	76TN2180(1)H3(2)	R76TN2180(1)H3(2)
1600	650	0.0220	6.0	15.0	26.5	22.5	3,000	9,600,000	66	16	29	3.50	43	76TN2220(1)H3(2)	R76TN2220(1)H3(2)
1600	650	0.0270	6.0	15.0	26.5	22.5	3,000	9,600,000	81	16	24	3.88	43	76TN2270(1)H3(2)	R76TN2270(1)H3(2)
1600	650	0.0330	6.0	15.0	26.5	22.5	3,000	9,600,000	99	16	19	4.28	43	76TN2330(1)H4(2)	R76TN2330(1)H4(2)
1600	650	0.0390	7.0	16.0	26.5	22.5	3,000	9,600,000	117	16	16	4.79	41	76TN2390(1)H4(2)	R76TN2390(1)H4(2)
1600	650	0.0470	7.0	16.0	26.5	22.5	3,000	9,600,000	141	16	14	5.26	41	76TN2470(1)H4(2)	R76TN2470(1)H4(2)
1600	650	0.0560	8.5	17.0	26.5	22.5	3,000	9,600,000	168	16	23	4.20	38	76TN2560(1)H4(2)	R76TN2560(1)H4(2)
1600	650	0.0680	10.0	18.5	26.5	22.5	3,000	9,600,000	204	16	19	4.79	36	76TN2680(1)H4(2)	R76TN2680(1)H4(2)
1600	650	0.0820	10.0	18.5	26.5	22.5	3,000	9,600,000	246	16	16	5.26	36	76TN2820(1)H4(2)	R76TN2820(1)H4(2)
1600	650	0.1000	11.0	20.0	26.5	22.5	3,000	9,600,000	300	16	13	5.96	34	76TN3100(1)H4(2)	R76TN3100(1)H4(2)
1600	650	0.0820	11.0	20.0	32.0	27.5	2,000	6,400,000	164	18	29	4.10	31	76TR2820(1)H3(2)	R76TR2820(1)H3(2)
1600	650	0.1000	11.0	20.0	32.0	27.5	2,000	6,400,000	200	18	24	4.53	31	76TR3100(1)H3(2)	R76TR3100(1)H3(2)
1600	650	0.1200	13.0	22.0	32.0	27.5	2,000	6,400,000	240	18	27	4.47	29	76TR3120(1)H3(2)	R76TR3120(1)H3(2)
1600	650	0.1500	13.0	25.0	32.0	27.5	2,000	6,400,000	300	18	21	5.11	28	76TR3150(1)H4(2)	R76TR3150(1)H4(2)
1600	650	0.1800	14.0	28.0	32.0	27.5	2,000	6,400,000	360	18	18	5.77	26	76TR3180(1)H4(2)	R76TR3180(1)H4(2)
1600	650	0.2200	18.0	33.0	32.0	27.5	2,000	6,400,000	440	18	14	6.81	23	76TR3220(1)H3(2)	R76TR3220(1)H3(2)
1600	650	0.2700	18.0	33.0	32.0	27.5	2,000	6,400,000	540	18	15	6.74	23	76TR3270(1)H3(2)	R76TR3270(1)H3(2)
1600	650	0.3300	18.0	33.0	32.0	27.5	2,000	6,400,000	660	18	12	7.46	23	76TR3330(1)H3(2)	R76TR3330(1)H3(2)
1600	650	0.3900	22.0	37.0	32.0	27.5	2,000	6,400,000	780	18	16	6.74	21	76TR3390(1)H3(2)	R76TR3390(1)H3(2)
1600	650	0.4700	22.0	37.0	32.0	27.5	2,000	6,400,000	940	18	14	7.40	21	76TR3470(1)H3(2)	R76TR3470(1)H3(2)
1600	650	0.0820	11.0	22.0	41.5	37.5	1,200	3,840,000	98	20	29	4.41	27	76TW2820(1)H3(2)	R76TW2820(1)H3(2)
1600	650	0.1000	11.0	22.0	41.5	37.5	1,200	3,840,000	120	20	24	4.88	27	76TW3100(1)H3(2)	R76TW3100(1)H3(2)
1600	650	0.1200	11.0	22.0	41.5	37.5	1,200	3,840,000	144	20	27	4.63	27	76TW3120(1)H3(2)	R76TW3120(1)H3(2)
1600	650	0.1500	11.0	22.0	41.5	37.5	1,200	3,840,000	180	20	21	5.17	27	76TW3150(1)H3(2)	R76TW3150(1)H3(2)
1600	650	0.1800	13.0	24.0	41.5	37.5	1,200	3,840,000	216	20	18	5.87	25	76TW3180(1)H3(2)	R76TW3180(1)H3(2)
1600	650	0.1800	24.0	15.0	41.5	37.5	1,200	3,840,000	216	20	18	5.97	24	76TW3180(1)HL(2)	R76TW3180(1)HL(2)
1600	650	0.2200	13.0	24.0	41.5	37.5	1,200	3,840,000	264	20	14	6.49	25	76TW3220(1)H3(2)	R76TW3220(1)H3(2)
1600	650	0.2200	24.0	15.0	41.5	37.5	1,200	3,840,000	264	20	14	6.60	24	76TW3220(1)HL(2)	R76TW3220(1)HL(2)
1600	650	0.2700	13.0	24.0	41.5	37.5	1,200	3,840,000	324	20	15	6.43	25	76TW3270(1)H3(2)	R76TW3270(1)H3(2)
1600	650	0.2700	24.0	15.0	41.5	37.5	1,200	3,840,000	324	20	15	6.54	24	76TW3270(1)HL(2)	R76TW3270(1)HL(2)
1600	650	0.3300	16.0	28.5	41.5	37.5	1,200	3,840,000	396	20	12	7.52	23	76TW3330(1)H3(2)	R76TW3330(1)H3(2)
VDC	VAC	Cap Value	T	H	L	Lead Spacing (S)	dV/dt (V/µs)	Max K ₀ (V ² /µs)	A _{pk}	Lead Length 2x 4 mm	at 100 kHz	at 100 kHz, 100°C	(°C/W)	KEMET Internal Part Number	Customer Part Number
									I _{pk}	ESL	ESR	I _{rms} max (*)	R _{th}		

(1) Insert lead and packaging code. See Ordering Options Table for available options.
(2) H = 2.5% (only for C ≥ 1,000 pF), J = 5%, K = 10%
(*) I_{rms} value that leads to a ΔT of ≈ 15°C in the hot spot > T_{HS} = T_{AMB} + ΔT = 100°C + 15°C = 115°C

Table 1 – Ratings & Part Number Reference cont.

VDC	VAC	Cap Value (µF)	Dimensions in mm			Lead Spacing (S)	dV/dt (V/µs)	Max K_0 (V ² /µs)	I_{pk}	ESL		ESR		I_{rms} max (*)		Rth	KEMET Internal Part Number	Customer Part Number
										Lead Length 2x 4 mm		at 100 kHz	I_{rms} max (*)	Rth				
			T	H	L					A_{pk}	nH	mΩ	at 100 kHz, 100°C	A_{rms}	(°C/W)			
1600	650	0.3300	24.0	15.0	41.5	37.5	1,200	3,840,000	396	20	12	7.23	24	76TW3330(1)H(2)	R76TW3330(1)H(2)			
1600	650	0.3900	16.0	28.5	41.5	37.5	1,200	3,840,000	468	20	16	6.46	23	76TW3390(1)H3(2)	R76TW3390(1)H3(2)			
1600	650	0.4700	19.0	32.0	41.5	37.5	1,200	3,840,000	564	20	14	7.41	21	76TW3470(1)H3(2)	R76TW3470(1)H3(2)			
1600	650	0.5600	20.0	40.0	41.5	37.5	1,200	3,840,000	672	20	11	8.49	19	76TW3560(1)H3(2)	R76TW3560(1)H3(2)			
1600	650	0.6800	20.0	40.0	41.5	37.5	1,200	3,840,000	816	20	11	8.82	19	76TW3680(1)H3(2)	R76TW3680(1)H3(2)			
1600	650	0.8200	24.0	44.0	41.5	37.5	1,200	3,840,000	984	20	9	10.11	17	76TW3820(1)H3(2)	R76TW3820(1)H3(2)			
1600	650	1.0000	24.0	44.0	41.5	37.5	1,200	3,840,000	1,200	20	7	11.16	17	76TW4100(1)H3(2)	R76TW4100(1)H3(2)			
1600	650	1.2000	30.0	45.0	41.5	37.5	1,200	3,840,000	1,440	20	16	7.77	16	76TW4120(1)H3(2)	R76TW4120(1)H3(2)			
2000	700	0.00056	4.0	10.0	18.0	15.0	9,500	38,000,000	5	10	1,137	0.25	65	76UI0560(1)H4(2)	R76UI0560(1)H4(2)			
2000	700	0.00056	5.0	11.0	18.0	15.0	9,500	38,000,000	5	10	1,137	0.25	60	76UI0560(1)H3(2)	R76UI0560(1)H3(2)			
2000	700	0.00068	4.0	10.0	18.0	15.0	9,500	38,000,000	6	10	936	0.30	65	76UI0680(1)H4(2)	R76UI0680(1)H4(2)			
2000	700	0.00068	5.0	11.0	18.0	15.0	9,500	38,000,000	6	10	936	0.30	60	76UI0680(1)H3(2)	R76UI0680(1)H3(2)			
2000	700	0.00082	4.0	10.0	18.0	15.0	9,500	38,000,000	8	10	776	0.36	65	76UI0820(1)H4(2)	R76UI0820(1)H4(2)			
2000	700	0.00082	5.0	11.0	18.0	15.0	9,500	38,000,000	8	10	776	0.36	60	76UI0820(1)H3(2)	R76UI0820(1)H3(2)			
2000	700	0.0010	4.0	10.0	18.0	15.0	9,500	38,000,000	10	10	637	0.44	65	76UI1100(1)H4(2)	R76UI1100(1)H4(2)			
2000	700	0.0010	5.0	11.0	18.0	15.0	9,500	38,000,000	10	10	637	0.44	60	76UI1100(1)H3(2)	R76UI1100(1)H3(2)			
2000	700	0.0012	4.0	10.0	18.0	15.0	9,500	38,000,000	11	10	531	0.53	65	76UI1120(1)H4(2)	R76UI1120(1)H4(2)			
2000	700	0.0012	5.0	11.0	18.0	15.0	9,500	38,000,000	11	10	531	0.53	60	76UI1120(1)H3(2)	R76UI1120(1)H3(2)			
2000	700	0.0015	4.0	10.0	18.0	15.0	9,500	38,000,000	14	10	424	0.66	65	76UI1150(1)H4(2)	R76UI1150(1)H4(2)			
2000	700	0.0015	5.0	11.0	18.0	15.0	9,500	38,000,000	14	10	424	0.66	60	76UI1150(1)H3(2)	R76UI1150(1)H3(2)			
2000	700	0.0018	4.0	10.0	18.0	15.0	9,500	38,000,000	17	10	354	0.79	65	76UI1180(1)H4(2)	R76UI1180(1)H4(2)			
2000	700	0.0018	5.0	11.0	18.0	15.0	9,500	38,000,000	17	10	354	0.79	60	76UI1180(1)H3(2)	R76UI1180(1)H3(2)			
2000	700	0.0022	4.0	10.0	18.0	15.0	9,500	38,000,000	21	10	289	0.90	65	76UI1220(1)H4(2)	R76UI1220(1)H4(2)			
2000	700	0.0022	5.0	11.0	18.0	15.0	9,500	38,000,000	21	10	289	0.90	60	76UI1220(1)H3(2)	R76UI1220(1)H3(2)			
2000	700	0.0027	4.0	10.0	18.0	15.0	9,500	38,000,000	26	10	236	1.00	65	76UI1270(1)H4(2)	R76UI1270(1)H4(2)			
2000	700	0.0027	5.0	11.0	18.0	15.0	9,500	38,000,000	26	10	236	1.04	60	76UI1270(1)H3(2)	R76UI1270(1)H3(2)			
2000	700	0.0033	5.0	11.0	18.0	15.0	9,500	38,000,000	31	10	193	1.15	60	76UI1330(1)H4(2)	R76UI1330(1)H4(2)			
2000	700	0.0039	5.0	11.0	18.0	15.0	9,500	38,000,000	37	10	163	1.25	60	76UI1390(1)H4(2)	R76UI1390(1)H4(2)			
2000	700	0.0047	5.0	11.0	18.0	15.0	9,500	38,000,000	45	10	135	1.37	60	76UI1470(1)H4(2)	R76UI1470(1)H4(2)			
2000	700	0.0056	6.0	12.0	18.0	15.0	9,500	38,000,000	53	10	114	1.56	56	76UI1560(1)H4(2)	R76UI1560(1)H4(2)			
2000	700	0.0068	6.0	12.0	18.0	15.0	9,500	38,000,000	65	10	94	1.71	56	76UI1680(1)H4(2)	R76UI1680(1)H4(2)			
2000	700	0.0082	6.0	12.0	18.0	15.0	9,500	38,000,000	78	10	78	1.88	56	76UI1820(1)H4(2)	R76UI1820(1)H4(2)			
2000	700	0.0100	7.5	13.5	18.0	15.0	9,500	38,000,000	95	10	64	2.18	51	76UI2100(1)H4(2)	R76UI2100(1)H4(2)			
2000	700	0.0100	13.0	12.0	18.0	15.0	9,500	38,000,000	95	10	64	2.32	45	76UI2100(1)H7(2)	R76UI2100(1)H7(2)			
2000	700	0.0120	8.5	14.5	18.0	15.0	9,500	38,000,000	114	10	53	2.46	48	76UI2120(1)H4(2)	R76UI2120(1)H4(2)			
2000	700	0.0150	8.5	14.5	18.0	15.0	9,500	38,000,000	143	10	42	2.75	48	76UI2150(1)H4(2)	R76UI2150(1)H4(2)			
2000	700	0.0022	6.0	15.0	26.5	22.5	4,500	18,000,000	10	16	289	0.97	43	76UN1220(1)H0(2)	R76UN1220(1)H0(2)			
2000	700	0.0027	6.0	15.0	26.5	22.5	4,500	18,000,000	12	16	236	1.19	43	76UN1270(1)H0(2)	R76UN1270(1)H0(2)			
2000	700	0.0033	6.0	15.0	26.5	22.5	4,500	18,000,000	15	16	193	1.35	43	76UN1330(1)H0(2)	R76UN1330(1)H0(2)			
2000	700	0.0039	6.0	15.0	26.5	22.5	4,500	18,000,000	18	16	163	1.47	43	76UN1390(1)H0(2)	R76UN1390(1)H0(2)			
2000	700	0.0047	6.0	15.0	26.5	22.5	4,500	18,000,000	21	16	135	1.62	43	76UN1470(1)H0(2)	R76UN1470(1)H0(2)			
2000	700	0.0056	6.0	15.0	26.5	22.5	4,500	18,000,000	25	16	114	1.77	43	76UN1560(1)H0(2)	R76UN1560(1)H0(2)			
2000	700	0.0068	6.0	15.0	26.5	22.5	4,500	18,000,000	31	16	94	1.95	43	76UN1680(1)H0(2)	R76UN1680(1)H0(2)			
2000	700	0.0082	6.0	15.0	26.5	22.5	4,500	18,000,000	37	16	78	2.14	43	76UN1820(1)H3(2)	R76UN1820(1)H3(2)			
2000	700	0.0100	6.0	15.0	26.5	22.5	4,500	18,000,000	45	16	64	2.36	43	76UN2100(1)H3(2)	R76UN2100(1)H3(2)			
2000	700	0.0120	6.0	15.0	26.5	22.5	4,500	18,000,000	54	16	53	2.58	43	76UN2120(1)H3(2)	R76UN2120(1)H3(2)			
2000	700	0.0150	6.0	15.0	26.5	22.5	4,500	18,000,000	68	16	42	2.89	43	76UN2150(1)H4(2)	R76UN2150(1)H4(2)			
2000	700	0.0180	6.0	15.0	26.5	22.5	4,500	18,000,000	81	16	35	3.16	43	76UN2180(1)H4(2)	R76UN2180(1)H4(2)			
2000	700	0.0220	7.0	16.0	26.5	22.5	4,500	18,000,000	99	16	29	3.60	41	76UN2220(1)H4(2)	R76UN2220(1)H4(2)			
2000	700	0.0270	7.0	16.0	26.5	22.5	4,500	18,000,000	122	16	24	3.99	41	76UN2270(1)H4(2)	R76UN2270(1)H4(2)			
2000	700	0.0330	8.5	17.0	26.5	22.5	4,500	18,000,000	149	16	19	4.56	38	76UN2330(1)H4(2)	R76UN2330(1)H4(2)			
VDC	VAC	Cap Value	T	H	L	Lead Spacing (S)	dV/dt (V/µs)	Max K_0 (V ² /µs)	A_{pk}	Lead Length 2x 4 mm	at 100 kHz	at 100 kHz, 100°C	(°C/W)	KEMET Internal Part Number	Customer Part Number			
									I_{pk}	ESL	ESR	I_{rms} max (*)	R_{th}					

(1) Insert lead and packaging code. See Ordering Options Table for available options.

(2) H = 2.5% (only for C ≥ 1,000 pF), J = 5%, K = 10%

(*) I_{rms} value that leads to a ΔT of ≈ 15°C in the hot spot > $T_{HS} = T_{AMB} + ΔT = 100°C + 15°C = 115°C$

Table 1 – Ratings & Part Number Reference cont.

VDC	VAC	Cap Value (µF)	Dimensions in mm			Lead Spacing (S)	dV/dt (V/µs)	Max K ₀ (V ² /µs)	I _{pk}	ESL	ESR	I _{rms} max (*)	R _{th}	KEMET Internal Part Number	Customer Part Number
			Lead Length 2x 4 mm	at 100 kHz	at 100 kHz, 100°C					R _{th}					
											A _{pk}	nH	mΩ		
T	H	L	A _{pk}	nH	mΩ	A _{rms}	(°C/W)								
2000	700	0.0390	10.0	18.5	26.5	22.5	4,500	18,000,000	176	16	16	5.13	36	76UN2390(1)H4(2)	R76UN2390(1)H4(2)
2000	700	0.0470	10.0	18.5	26.5	22.5	4,500	18,000,000	212	16	14	5.63	36	76UN2470(1)H4(2)	R76UN2470(1)H4(2)
2000	700	0.0560	11.0	20.0	26.5	22.5	4,500	18,000,000	252	16	23	4.46	34	76UN2560(1)H4(2)	R76UN2560(1)H4(2)
2000	700	0.0390	11.0	20.0	32.0	27.5	2,500	10,000,000	98	18	41	3.46	31	76UR2390(1)H2(2)	R76UR2390(1)H2(2)
2000	700	0.0470	11.0	20.0	32.0	27.5	2,500	10,000,000	118	18	34	3.80	31	76UR2470(1)H3(2)	R76UR2470(1)H3(2)
2000	700	0.0560	13.0	22.0	32.0	27.5	2,500	10,000,000	140	18	43	3.52	29	76UR2560(1)H3(2)	R76UR2560(1)H3(2)
2000	700	0.0680	13.0	22.0	32.0	27.5	2,500	10,000,000	170	18	35	3.88	29	76UR2680(1)H3(2)	R76UR2680(1)H3(2)
2000	700	0.0820	13.0	25.0	32.0	27.5	2,500	10,000,000	205	18	29	4.36	28	76UR2820(1)H4(2)	R76UR2820(1)H4(2)
2000	700	0.1000	14.0	28.0	32.0	27.5	2,500	10,000,000	250	18	24	4.97	26	76UR3100(1)H3(2)	R76UR3100(1)H3(2)
2000	700	0.1200	18.0	33.0	32.0	27.5	2,500	10,000,000	300	18	27	5.03	23	76UR3120(1)H3(2)	R76UR3120(1)H3(2)
2000	700	0.1500	18.0	33.0	32.0	27.5	2,500	10,000,000	375	18	21	5.62	23	76UR3150(1)H3(2)	R76UR3150(1)H3(2)
2000	700	0.1800	22.0	37.0	32.0	27.5	2,500	10,000,000	450	18	18	6.47	21	76UR3180(1)H3(2)	R76UR3180(1)H3(2)
2000	700	0.2200	22.0	37.0	32.0	27.5	2,500	10,000,000	550	18	14	7.16	21	76UR3220(1)H3(2)	R76UR3220(1)H3(2)
2000	700	0.0330	11.0	22.0	41.5	37.5	1,500	6,000,000	50	20	48	3.43	27	76UW2330(1)H3(2)	R76UW2330(1)H3(2)
2000	700	0.0390	11.0	22.0	41.5	37.5	1,500	6,000,000	59	20	41	3.73	27	76UW2390(1)H3(2)	R76UW2390(1)H3(2)
2000	700	0.0470	11.0	22.0	41.5	37.5	1,500	6,000,000	71	20	34	4.09	27	76UW2470(1)H3(2)	R76UW2470(1)H3(2)
2000	700	0.0560	11.0	22.0	41.5	37.5	1,500	6,000,000	84	20	43	3.65	27	76UW2560(1)H3(2)	R76UW2560(1)H3(2)
2000	700	0.0680	11.0	22.0	41.5	37.5	1,500	6,000,000	102	20	35	4.02	27	76UW2680(1)H3(2)	R76UW2680(1)H3(2)
2000	700	0.0820	11.0	22.0	41.5	37.5	1,500	6,000,000	123	20	29	4.41	27	76UW2820(1)H3(2)	R76UW2820(1)H3(2)
2000	700	0.0820	24.0	15.0	41.5	37.5	1,500	6,000,000	123	20	29	4.65	24	76UW2820(1)HL(2)	R76UW2820(1)HL(2)
2000	700	0.1000	13.0	24.0	41.5	37.5	1,500	6,000,000	150	20	24	5.05	25	76UW3100(1)H3(2)	R76UW3100(1)H3(2)
2000	700	0.1000	24.0	15.0	41.5	37.5	1,500	6,000,000	150	20	24	5.14	24	76UW3100(1)HL(2)	R76UW3100(1)HL(2)
2000	700	0.1200	13.0	24.0	41.5	37.5	1,500	6,000,000	180	20	27	4.79	25	76UW3120(1)H3(2)	R76UW3120(1)H3(2)
2000	700	0.1200	24.0	15.0	41.5	37.5	1,500	6,000,000	180	20	27	4.88	24	76UW3120(1)HL(2)	R76UW3120(1)HL(2)
2000	700	0.1500	16.0	28.5	41.5	37.5	1,500	6,000,000	225	20	21	5.67	23	76UW3150(1)H3(2)	R76UW3150(1)H3(2)
2000	700	0.1500	24.0	19.0	41.5	37.5	1,500	6,000,000	225	20	21	5.63	23	76UW3150(1)HL(2)	R76UW3150(1)HL(2)
2000	700	0.1800	16.0	28.5	41.5	37.5	1,500	6,000,000	270	20	18	6.21	23	76UW3180(1)H3(2)	R76UW3180(1)H3(2)
2000	700	0.1800	24.0	19.0	41.5	37.5	1,500	6,000,000	270	20	18	6.17	23	76UW3180(1)HL(2)	R76UW3180(1)HL(2)
2000	700	0.2200	19.0	32.0	41.5	37.5	1,500	6,000,000	330	20	14	7.17	21	76UW3220(1)H3(2)	R76UW3220(1)H3(2)
2000	700	0.2700	20.0	40.0	41.5	37.5	1,500	6,000,000	405	20	15	7.46	19	76UW3270(1)H3(2)	R76UW3270(1)H3(2)
2000	700	0.3300	20.0	40.0	41.5	37.5	1,500	6,000,000	495	20	12	8.25	19	76UW3330(1)H3(2)	R76UW3330(1)H3(2)
2000	700	0.3900	24.0	44.0	41.5	37.5	1,500	6,000,000	585	20	16	7.39	17	76UW3390(1)H3(2)	R76UW3390(1)H3(2)
2000	700	0.4700	24.0	44.0	41.5	37.5	1,500	6,000,000	705	20	14	8.12	17	76UW3470(1)H3(2)	R76UW3470(1)H3(2)
2000	700	0.5600	30.0	45.0	41.5	37.5	1,500	6,000,000	840	20	11	9.19	16	76UW3560(1)H3(2)	R76UW3560(1)H3(2)
VDC	VAC	Cap Value	T	H	L	Lead Spacing (S)	dV/dt (V/µs)	Max K ₀ (V ² /µs)	A _{pk}	Lead Length 2x 4 mm	at 100 kHz	at 100 kHz, 100°C	(°C/W)	KEMET Internal Part Number	Customer Part Number
									I _{pk}	ESL	ESR	I _{rms} max (*)	R _{th}		

(1) Insert lead and packaging code. See Ordering Options Table for available options.

(2) H = 2.5% (only for C ≥ 1,000 pF), J = 5%, K = 10%

(*) I_{rms} value that leads to a ΔT of ≈ 15°C in the hot spot > T_{HS} = T_{AMB} + ΔT = 100°C + 15°C = 115°C

Soldering Process

The implementation of the RoHS directive has resulted in the selection of SnAgCu (SAC) alloys or SnCu alloys as primary solder. This has increased the liquidus temperature from that of 183°C for SnPb eutectic alloy to 217 – 221°C for the new alloys. As a result, the heat stress to the components, even in wave soldering, has increased considerably due to higher pre-heat and wave temperatures. Polypropylene capacitors are especially sensitive to heat (the melting point of polypropylene is 160 – 170°C). Wave soldering can be destructive, especially for mechanically small polypropylene capacitors (with lead spacing of 5 mm to 15 mm), and great care has to be taken during soldering. The recommended solder profiles from KEMET should be used. Please consult KEMET with any questions. In general, the wave soldering curve from IEC Publication 61760–1 Edition 2 serves as a solid guideline for successful soldering. Please see Figure 1.

Reflow soldering is not recommended for through-hole film capacitors. Exposing capacitors to a soldering profile in excess of the above recommended limits may result in degradation or permanent damage to the capacitors.

Do not place the polypropylene capacitor through an adhesive curing oven to cure resin for surface mount components. Insert through-hole parts after the curing of surface mount parts. Consult KEMET to discuss the actual temperature profile in the oven, if through-hole components must pass through the adhesive curing process. A maximum two soldering cycles is recommended. Please allow time for the capacitor surface temperature to return to a normal temperature before the second soldering cycle.

Manual Soldering Recommendations

Following is the recommendation for manual soldering with a soldering iron.

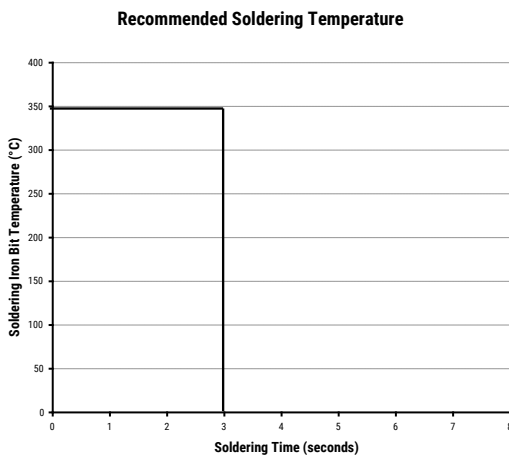

The soldering iron tip temperature should be set at 350°C (+10°C maximum) with the soldering duration not to exceed more than 3 seconds.

Wave Soldering Recommendations

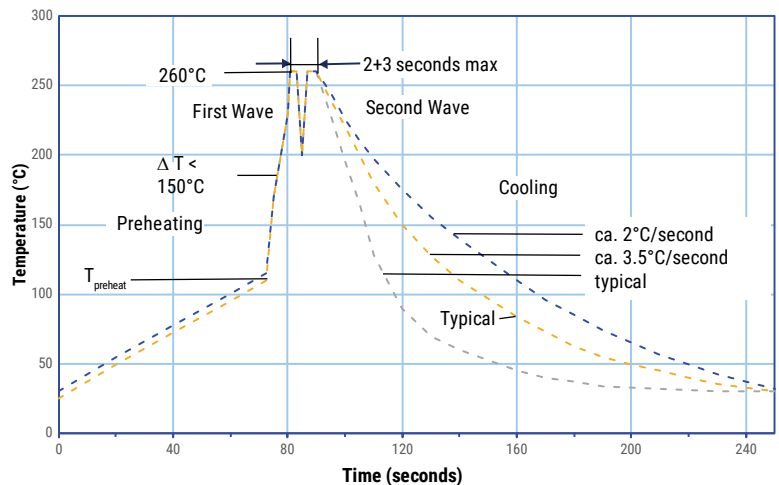

Soldering Process cont.

Wave Soldering Recommendations cont.

1. The table indicates the maximum set-up temperature of the soldering process

Figure 1

Film Material	Maximum Preheat Temperature			Maximum Peak Soldering Temperature	
	Capacitor Pitch ≤ 10 mm	Capacitor Pitch = 15 mm	Capacitor Pitch > 15 mm	Capacitor Pitch ≤ 15 mm	Capacitor Pitch > 15 mm
Double Metallized Polystyrene and Single Metallized Polypropylene	110°C	110°C	130°C	260°C	270°C

2. The maximum temperature measured on the capacitor body:

Set the temperature so that the maximum temperature is below the limit:

Film Material	Maximum Temperature Measured on the Capacitor Body
Double Metallized Polystyrene and Single Metallized Polypropylene	120°C (for series R76) 125°C (for series R76 125°)

Duration: < 60 seconds

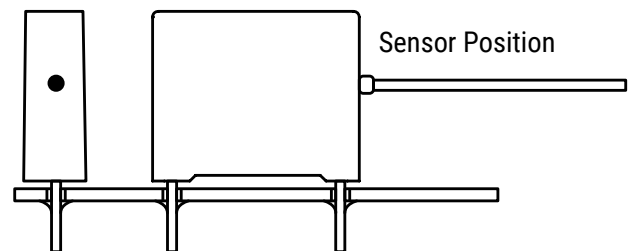

Selective Soldering Recommendations

Selective dip soldering is a variation of reflow soldering. In this method, the printed circuit board with through-hole components to be soldered is preheated and transported over the solder bath as in normal flow soldering without touching the solder. When the board is over the bath, it is stopped and pre-designed solder pots are lifted from the bath with molten solder only at the places of the selected components, and pressed against the lower surface of the board to solder the components.

The temperature profile for selective soldering is similar to the double wave flow soldering outlined in this document, **however, instead of two baths, there is only one bath with a time from 3 to 10 seconds.** In selective soldering, the risk of overheating is greater than in double wave flow soldering, and great care must be taken so that the parts are not overheated.

Mounting

Resistance to Vibration and Mechanical Shock

AEC-Q200 Mechanical Stress Tests:

Mechanical Shock	MIL-SDT-202 Method 213	Test condition C Peak value 100 g, duration 6 ms, half-sine-wave (see MIL-HDBK for details)
Vibration	MIL-SDT-202 Method 204	5 g for 20 minutes, 12 cycles each of 3 orientations Use 8"X5" PCB, 0.031" thick. 7 secure points on one 8" side and 2 secure points at corners of opposite sides. Parts mounted within 2" from any secure point. Test from 10 – 2,000 Hz.

The capacitors are designed for PCB mounting. The stand-off pipes must be in good contact with the printed circuit board. The capacitors with pitch ≤ 22.5 mm can be mechanically fixed by the leads, for pitch > 22.5 mm, the capacitor body has to be properly fixed (e.g. clamped or glued).

Construction

1 Section

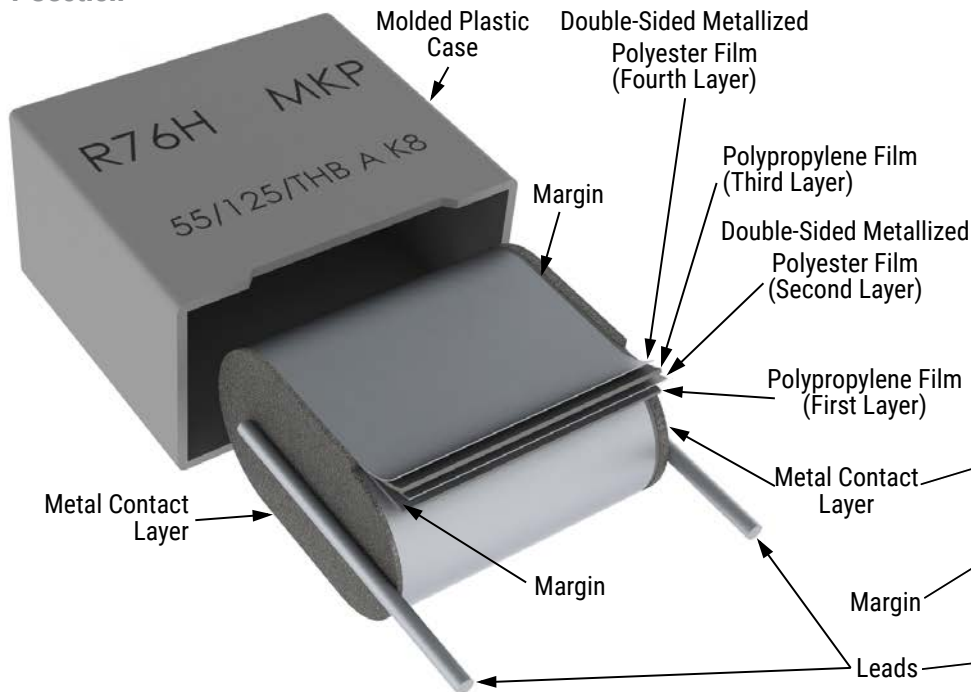

Detailed Cross Section

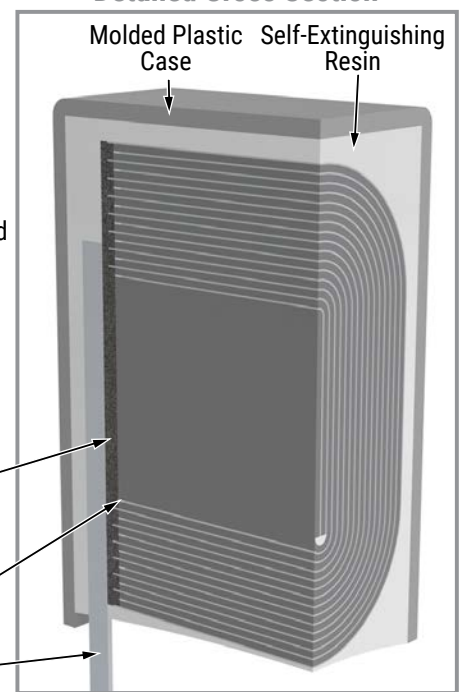

Construction cont.

Winding Schemes

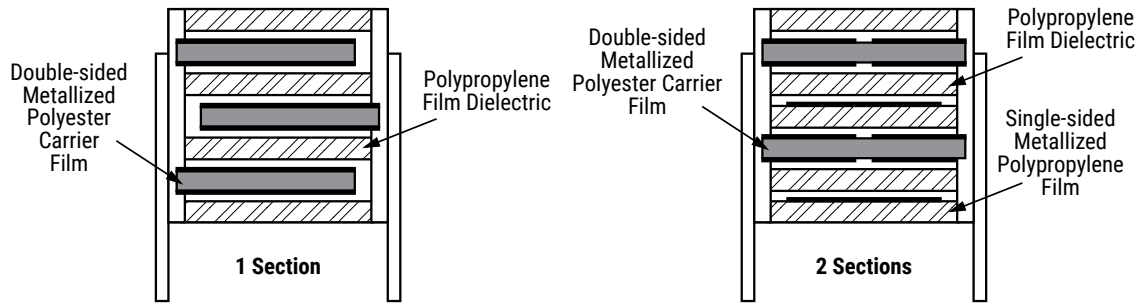

Low Profile Version

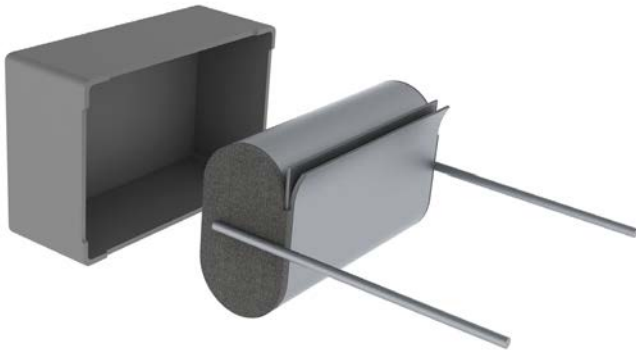

Marking

Pitch – 10, 15, & 22.5

Marking Variants*

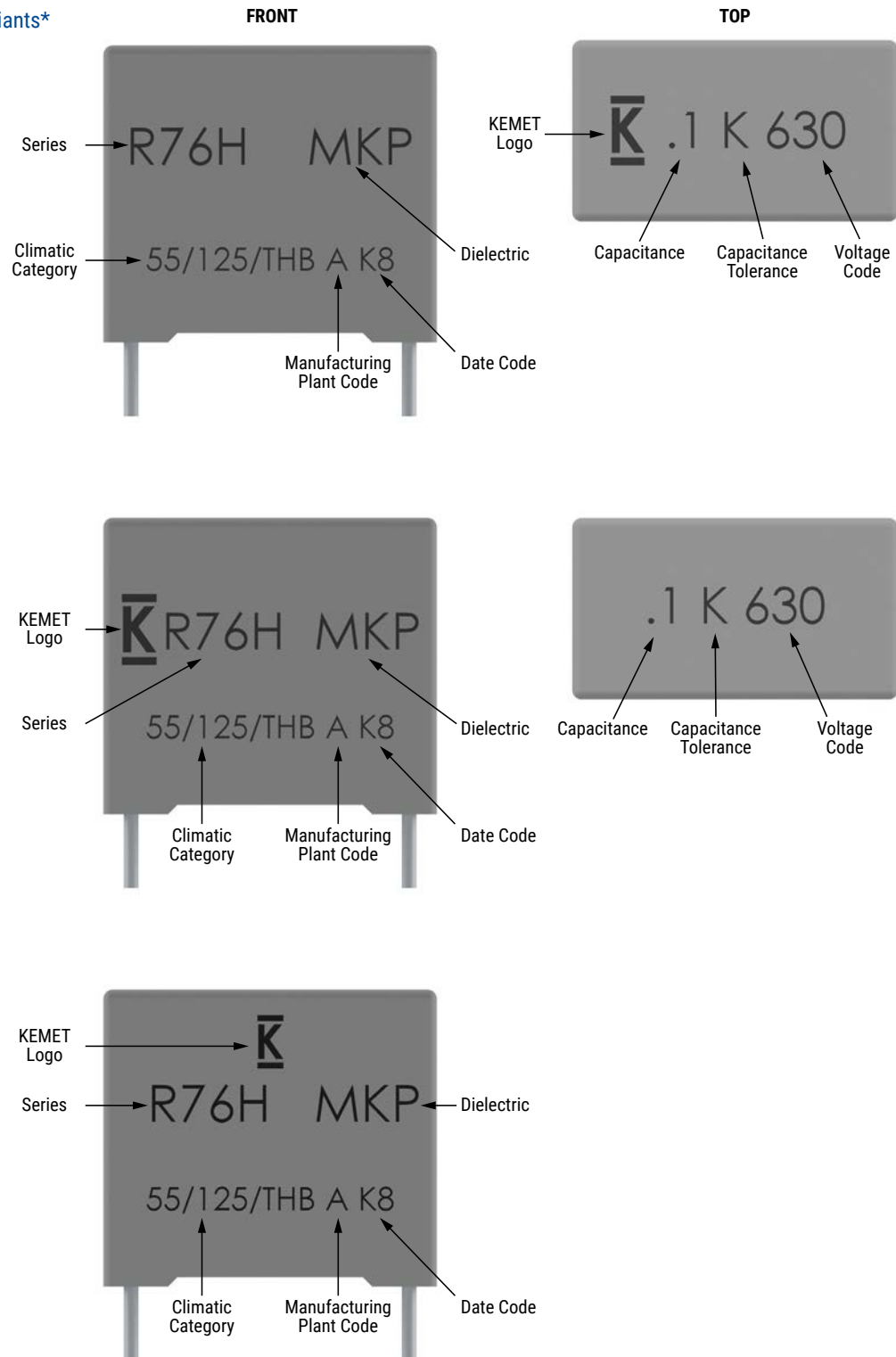

* Differences are caused by technology (clichee, laser, or ink) and technic (production line)

Marking cont.

Pitch – 10, 15, 22.5, 27.5, & 37.5

Marking Variants*

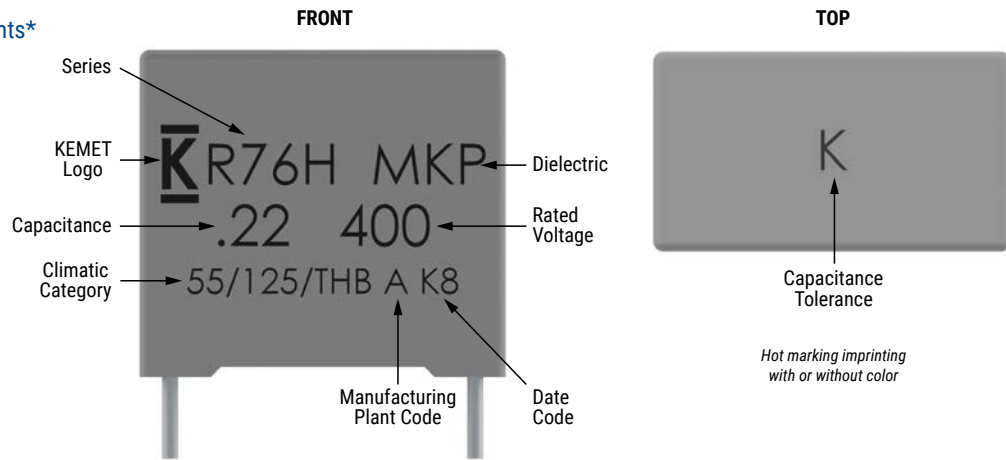

Pitch – 22.5, 27.5, & 37.5

Marking Variants*

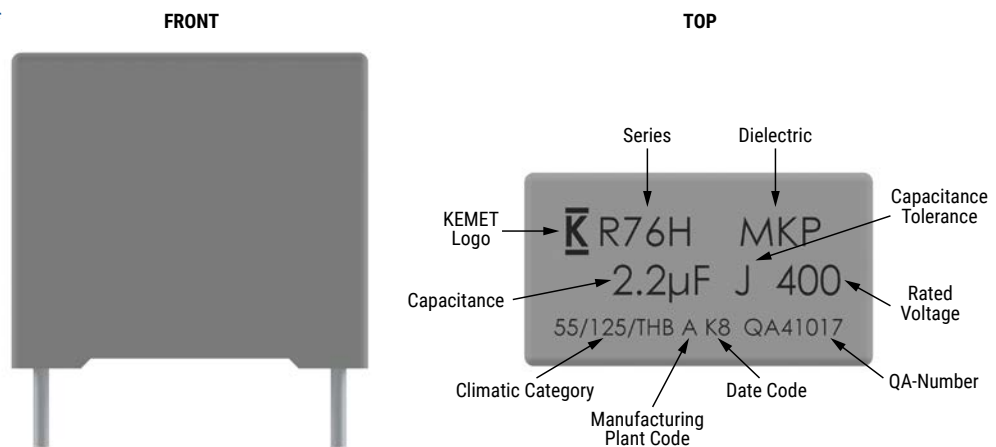

* Differences are caused by technology (clichee, laser, or ink) and technic (production line)

Packaging Quantities

Lead Spacing	Thickness (mm)	Height (mm)	Length (mm)	Bulk Short Leads	Bulk Long Leads		Standard Reel ø 355 mm	Large Reel ø 500 mm	Ammo Taped
	Lead and Packaging Code			JA - JB JE - JH - SE	Z3 - JM ¹	40 - 50	GY - CK	CK	DQ
10	4.0	9.0	13.0	2,000	2,200	1,800	750	1,500	1,000
	5.0	11.0	13.0	1,300	2,000	1,500	600	1,250	800
	6.0	12.0	13.0	1,000	1,800	1,200	500	1,000	680
15	4.0	10.0	18.0	2,500	1,500	1,500	750	1,500	1,000
	5.0	11.0	18.0	2,000	1,250	1,000	600	1,250	800
	6.0	12.0	18.0	1,750	1,000	900	500	1,000	680
	7.5	13.5	18.0	1,000	800	700	350	800	500
	8.5	14.5	18.0	1,000	650	500	300	700	440
	9.0	12.5	18.0	1,000	700	520	270	650	410
	10.0	16.0	18.0	750	550	500	270	600	380
	11.0	19.0	18.0	450	400	350	270	500	340
	13.0	12.0	18.0	750	520	490	200	480	280
22.5	6.0	15.0	26.5	805	450	500	300	700	464
	7.0	16.0	26.5	700	450	500	250	550	380
	8.5	17.0	26.5	468	350	300	250	450	280
	10.0	18.5	26.5	396	350	300	160	350	235
	11.0	20.0	26.5	360	200	250	190	350	217
	13.0	22.0	26.5	300	150	200	130	300	-
27.5	9.0	17.0	32.0	816	-	408	230	450	-
	11.0	20.0	32.0	560	-	336	190	350	-
	13.0	12.0	32.0	672	-	288	-	-	-
	13.0	22.0	32.0	480	-	288	150	300	-
	13.0	25.0	32.0	480	-	288	-	300	-
	14.0	28.0	32.0	352	-	176	-	-	-
	18.0	33.0	32.0	256	-	128	-	-	-
	22.0	37.0	32.0	168	-	112	-	-	-
37.5	11.0	22.0	41.5	420	-	252	-	-	-
	13.0	24.0	41.5	360	-	216	-	-	-
	16.0	28.5	41.5	216	-	108	-	-	-
	19.0	32.0	41.5	192	-	96	-	-	-
	20.0	40.0	41.5	126	-	84	-	-	-
	24.0	15.0	41.5	252	-	108	-	-	-
	24.0	19.0	41.5	216	-	108	-	-	-
	24.0	44.0	41.5	108	-	72	-	-	-
	30.0	45.0	41.5	90	-	60	-	-	-

¹ Only for > 7.5 mm lead spacing.

Lead Taping & Packaging (IEC 60286-2)

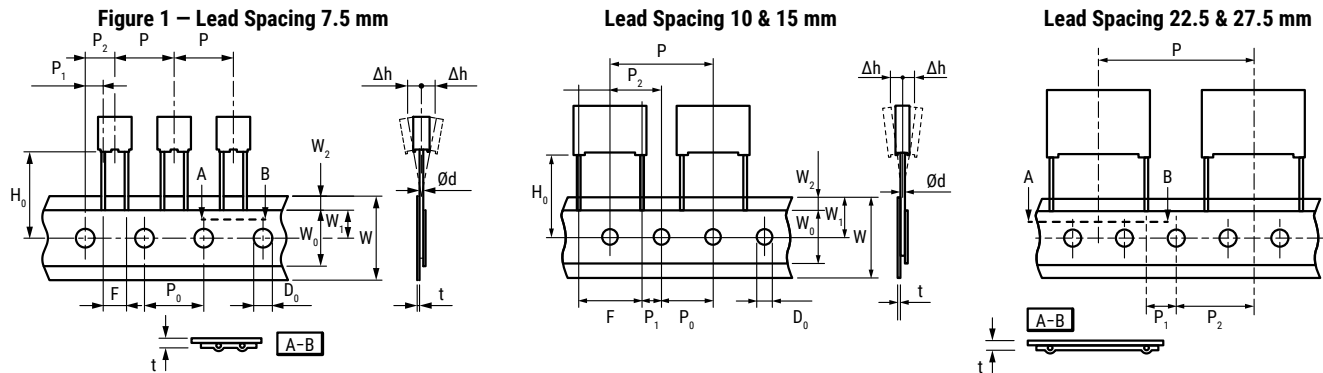

Taping Specification

Description	Symbol	Dimensions (mm)					Tolerance
		Lead Spacing					
		7.5	10.0	15.0	22.5	27.5	
Lead wire diameter	d	0.5 – 0.6	0.6	0.6 – 0.8	0.8	0.8	±0.05
Taping lead space	P	12.7	25.4	25.4	38.1	38.1	±1
Feed hole lead space *	P ₀	12.7	12.7	12.7	12.7	12.7	±0.2 **
Centering of the lead wire	P ₁	2.6	7.7	5.2	7.8	5.3	±0.7
Centering of the body	P ₂	6.35	12.7	12.7	19.05	19.05	±1.3
Lead spacing ***	F	7.5	10.0	15.0	22.5	27.5	+0.6/-0.1
Component alignment	Δh	0	0	0	0	0	±2
Component deviation	Δp	0	0	0	0	0	±1
Height of component from tape center	H ₀ ****	18.5	18.5	18.5	18.5	18.5	±0.5
Carrier tape width	W	18	18	18	18	18	+1/-0.5
Hold down tape width	W ₀	6	9	10	10	10	Minimum
Hole position	W ₁	9	9	9	9	9	±0.5
Hold down tape position	W ₂	3	3	3	3	3	Maximum
Feed hole diameter	D ₀	4	4	4	4	4	±0.2
Total Tape thickness	t	0.7	0.7	0.7	0.7	0.7	±0.2

* Available also 15 mm.

** Maximum 1 mm on 20 lead spacing.

*** 15 mm and 10 mm taped to 7.5 mm (crimped leads) available upon request.

**** H₀ = 16.5 mm is available upon request.

Lead Taping & Packaging (IEC 60286-2) cont.

Ammo Specifications

Dimensions (mm)		
H	W	T
360	340	59

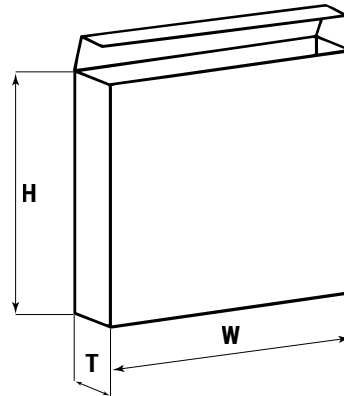

Reel Specifications

Dimensions (mm)		
D	H	W
355	30	55 Maximum
500	25	

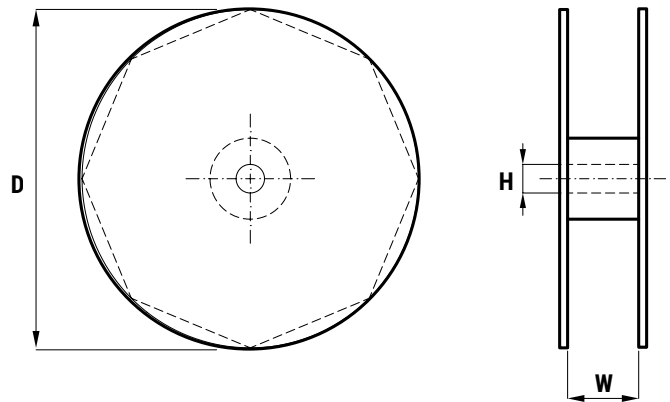

Manufacturing Date Code (IEC-60062)

Y = Year, Z = Month			
Year	Code	Month	Code
2010	A	January	1
2011	B	February	2
2012	C	March	3
2013	D	April	4
2014	E	May	5
2015	F	June	6
2016	H	July	7
2017	J	August	8
2018	K	September	9
2019	L	October	0
2020	M	November	N
2021	N	December	D
2022	P		
2023	R		
2024	S		
2025	T		
2026	U		
2027	V		
2028	W		
2029	X		
2030	A		

KEMET Electronics Corporation Sales Offices

For a complete list of our global sales offices, please visit www.kemet.com/sales.

Disclaimer

All product specifications, statements, information and data (collectively, the "Information") in this datasheet are subject to change. The customer is responsible for checking and verifying the extent to which the Information contained in this publication is applicable to an order at the time the order is placed. All Information given herein is believed to be accurate and reliable, but it is presented without guarantee, warranty, or responsibility of any kind, expressed or implied.

Statements of suitability for certain applications are based on KEMET Electronics Corporation's ("KEMET") knowledge of typical operating conditions for such applications, but are not intended to constitute – and KEMET specifically disclaims – any warranty concerning suitability for a specific customer application or use. The Information is intended for use only by customers who have the requisite experience and capability to determine the correct products for their application. Any technical advice inferred from this Information or otherwise provided by KEMET with reference to the use of KEMET's products is given gratis, and KEMET assumes no obligation or liability for the advice given or results obtained.

Although KEMET designs and manufactures its products to the most stringent quality and safety standards, given the current state of the art, isolated component failures may still occur. Accordingly, customer applications which require a high degree of reliability or safety should employ suitable designs or other safeguards (such as installation of protective circuitry or redundancies) in order to ensure that the failure of an electrical component does not result in a risk of personal injury or property damage.

Although all product-related warnings, cautions and notes must be observed, the customer should not assume that all safety measures are indicated or that other measures may not be required.

KEMET is a registered trademark of KEMET Electronics Corporation.