

SILICON NPN SWITCHING TRANSISTOR

- STMicroelectronics PREFERRED SALESTYPE
- NPN TRANSISTOR
- VERY HIGH SWITCHING SPEED

APPLICATIONS:

- HORIZONTAL DEFLECTION FOR MONOCHROME TV

DESCRIPTION

The BU406 is a silicon Epitaxial Planar NPN transistor in Jedec TO-220 plastic package.

It is a fast switching device for use in horizontal deflection output stages of large screens MTV receivers with 110° CRT.

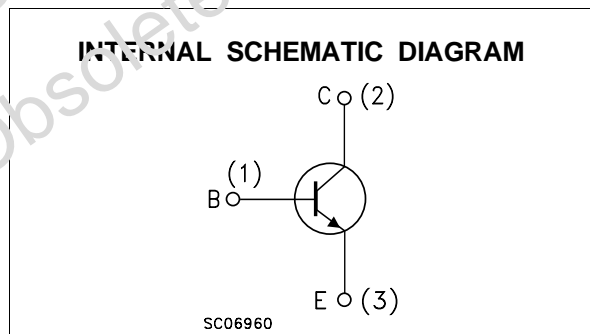
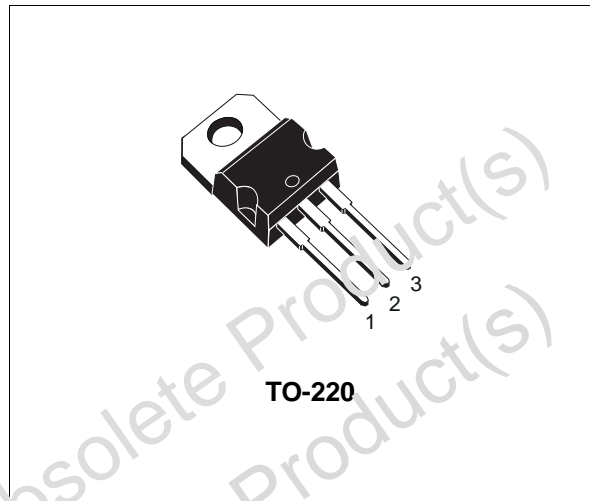
ABSOLUTE MAXIMUM RATINGS

SymLoI	Parameter	Value	Unit
V_{CBO}	Collector-Base Voltage ($I_E = 0$)	400	V
V_{CEV}	Collector-Emitter Voltage ($V_{BE} = -1.5$ V)	400	V
V_{CEO}	Collector-Emitter Voltage ($I_B = 0$)	200	V
V_{EBO}	Emitter-Base Voltage ($I_C = 0$)	6	V
I_C	Collector Current	7	A
I_{CM}	Collector Peak Current (repetitive)	10	A
I_{CM}	Collector Peak Current ($t_p < 10$ ms)	15	A
I_B	Base Current	4	A
P_{tot}	Total Dissipation at $T_c \leq 25$ °C	60	W
T_{stg}	Storage Temperature	-65 to 150	°C
T_j	Max. Operating Junction Temperature	150	°C

BU406

THERMAL DATA

R _{thj-case}	Thermal Resistance Junction-case	Max	2.08	°C/W
R _{thj-amb}	Thermal Resistance Junction-ambient	Max	70	°C/W

ELECTRICAL CHARACTERISTICS (T_{case} = 25 °C unless otherwise specified)

Symbol	Parameter	Test Conditions		Min.	Typ.	Max.	Unit
I _{CES}	Collector Cut-off Current (V _{BE} = 0)	V _{CE} = 400 V V _{CE} = 250 V V _{CE} = 250 V	T _c = 150°C			5 100 1	mA μA mA
I _{EBO}	Emitter Cut-off Current (I _C = 0)	V _{EB} = 6 V				1	mA
V _{CE(sat)*}	Collector-emitter Saturation Voltage	I _C = 5 A	I _B = 0.5 A			1	V
V _{BE(sat)*}	Base-emitter Saturation Voltage	I _C = 5 A	I _B = 0.5 A			1.2	V
f _T	Transition-Frequency	I _C = 0.5 A	V _{CE} = 10V	10			MHz
t _{off}	Turn-off Time	I _C = 5 A	I _{Bend} = 0.5 A			0.75	μs
I _{s/b}	Second Breakdown Collector Current	V _{CE} = 40 V	t = 10 ms		4		A

* Pulsed: Pulse duration = 300 μs, duty cycle 1.5 %.

TO-220 MECHANICAL DATA

DIM.	mm			inch		
	MIN.	TYP.	MAX.	MIN.	TYP.	MAX.
A	4.40		4.60	0.173		0.181
C	1.23		1.32	0.048		0.052
D	2.40		2.72	0.094		0.107
E	0.49		0.70	0.019		0.027
F	0.61		0.88	0.024		0.034
F1	1.14		1.70	0.044		0.067
F2	1.14		1.70	0.044		0.067
G	4.95		5.15	0.194		0.202
G1	2.40		2.70	0.094		0.106
H2	10.00		10.40	0.394		0.409
L2		16.40			0.645	
L4	13.00		14.00	0.511		0.551
L5	2.65		2.95	0.104		0.116
L6	15.25		15.75	0.600		0.620
L7	6.20		6.60	0.244		0.260
L9	3.50		3.90	0.137		0.154
M		2.60			0.102	
DIA.	3.75		3.83	0.147		0.151

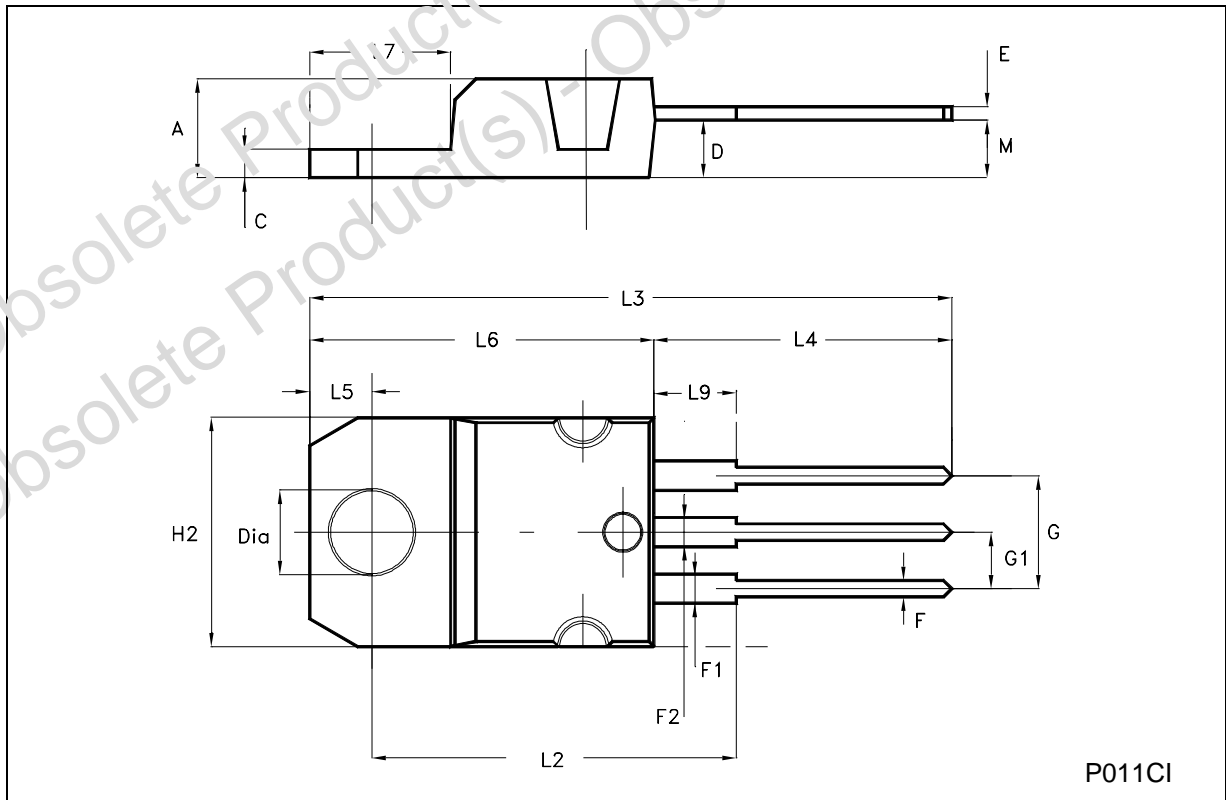

Obsolete Product(s) - Obsolete Product(s)
Obsolete Product(s) - Obsolete Product(s)

Information furnished is believed to be accurate and reliable. However, STMicroelectronics assumes no responsibility for the consequences of use of such information nor for any infringement of patents or other rights of third parties which may result from its use. No license is granted by implication or otherwise under any patent or patent rights of STMicroelectronics. Specification mentioned in this publication are subject to change without notice. This publication supersedes and replaces all information previously supplied. STMicroelectronics products are not authorized for use as critical components in life support devices or systems without express written approval of STMicroelectronics.

The ST logo is a trademark of STMicroelectronics

© 2003 STMicroelectronics – Printed in Italy – All Rights Reserved

STMicroelectronics GROUP OF COMPANIES

Australia - Brazil - Canada - China - Finland - France - Germany - Hong Kong - India - Israel - Italy - Japan - Malaysia - Malta - Morocco - Singapore - Spain - Sweden - Switzerland - United Kingdom - United States.

<http://www.st.com>

