

## 16 A Triac, high temperature and logic level

Datasheet – production data

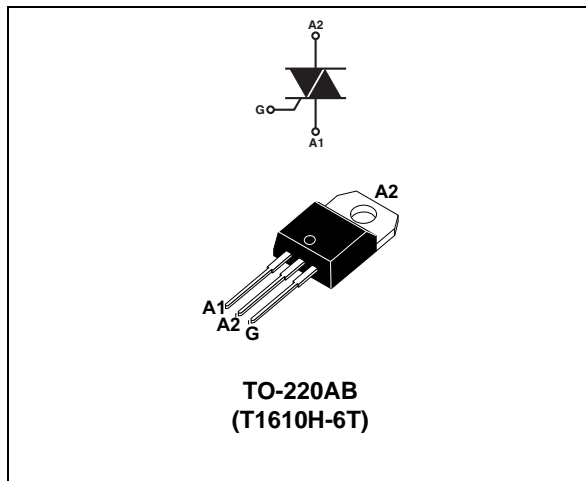

### Features

- Junction temperature up to 150 °C max.
- Logic level gate current: 10 mA
- Repetitive peak off-state voltage: 600 V
- High  $I_{TSM}$
- High thermal cycling performance

### Applications

- Electric heater
- Water heater, room heater
- Coffee machine
- Hand dryer
- Thermostat

### Description

This clip technology Triac has very high thermal cycling performance, and the design structure presents a higher  $I_{TSM}$ . The 150 °C maximum junction temperature of this device offers easier thermal management. Its 10 mA gate current offers direct drive from a microcontroller, mainly for resistive load control.

**Table 1. Device summary**

Order code	Package	$V_{DRM}$ , $V_{RRM}$	$I_{GT}$	$I_T(RMS)$
T1610H-6T	TO-220AB	600 V	10 mA	16 A

# 1 Characteristics

**Table 2. Absolute maximum rating ( $T_j = 25\text{ }^\circ\text{C}$ , unless otherwise specified)**

Symbol	Parameter		Value	Unit
$I_{T(RMS)}$	On-state rms current (180° conduction angle)	$T_c = 133\text{ }^\circ\text{C}$	16	A
$I_{TSM}$	Non repetitive surge peak on-state current, $T_j$ initial = 25 °C	$t_p = 16.7\text{ ms}$	168	A
		$t_p = 20\text{ms}$	160	
$I^2t$	$I^2t$ Value for fusing	$t_p = 10\text{ ms}$	169	A <sup>2</sup> s
di/dt	Critical rate of rise of on-state current, $I_G = 2 \times I_{GT}$ , $t_r \leq 100\text{ ns}$	$F = 60\text{ Hz}$	100	A/ $\mu$ s
$V_{DRM}$ , $V_{RRM}$	Repetitive peak off-state voltage	$T_j = 150\text{ }^\circ\text{C}$	600	V
$V_{DSM}$ , $V_{RSM}$	Non repetitive peak off-state voltage	$t_p = 10\text{ ms}$	700	V
$I_{GM}$	Peak gate current	$t_p = 20\text{ }\mu\text{s}$	4	A
$P_{GM}$	Peak gate power dissipation	$t_p = 20\text{ }\mu\text{s}$	10	W
$P_{G(AV)}$	Average gate power dissipation		1	W
$T_{stg}$ $T_j$	Storage junction temperature range Operating junction temperature range		-40 to +150	°C
$T_L$	Lead temperature for soldering during 10 s		260	°C

**Table 3. Electrical characteristics ( $T_j = 25\text{ }^\circ\text{C}$ , unless otherwise specified)**

Symbol	Test conditions	Quadrant		Value	Unit	
$I_{GT}$	$V_D = 12\text{ V}$ , $R_L = 33\text{ }\Omega$	I - II - III	MIN.	0.5	mA	
			MAX.	10	mA	
$V_{GT}$	$V_D = 12\text{ V}$ , $R_L = 33\text{ }\Omega$	I - II - III	MAX.	1.3	V	
$V_{GD}$	$V_D = V_{DRM}$ , $R_L = 3.3\text{ k}\Omega$ , $T_j = 150\text{ }^\circ\text{C}$	I - II - III	MIN.	0.2	V	
$I_H$	$I_T = 500\text{ mA}$ , gate open	–	MAX.	15	mA	
$I_L$	$I_G = 1.2 I_{GT}$	I - II - III	MAX.	30	mA	
dV/dt	$V_D = 67\% \times V_{DRM}$ , $V_{RRM}$ , gate open	$T_j = 150\text{ }^\circ\text{C}$	–	MIN.	100	V/ $\mu$ s
(di/dt)c	(dV/dt)c = 0.1 V/ $\mu$ s	$T_j = 150\text{ }^\circ\text{C}$	–	MIN.	8.5	A/ms
	(dV/dt)c = 10 V/ $\mu$ s		–		3	
$t_{gt}$	$I_{TM} = 13\text{ A}$ , $V_D = 400\text{ V}$ , $I_G = 100\text{ mA}$ , $di_G/dt = 100\text{ mA}/\mu\text{s}$ , $R_L = 30\text{ }\Omega$	–	TYP.	2	$\mu$ s	

Table 4. Static characteristics

Symbol	Test conditions		Value	Unit	
$V_{TM}$	$I_{TM} = 22.5 \text{ A}$ , $t_p = 380 \mu\text{s}$	$T_j = 25 \text{ }^\circ\text{C}$	MAX.	1.55	V
$V_{to}$	Threshold voltage	$T_j = 150 \text{ }^\circ\text{C}$		0.80	V
$R_d$	Dynamic resistance	$T_j = 150 \text{ }^\circ\text{C}$		22	m $\Omega$
$I_{DRM}$ , $I_{RRM}$	$V_D = V_{DRM}$ , $V_R = V_{RRM}$	$T_j = 25 \text{ }^\circ\text{C}$		5	$\mu\text{A}$
		$T_j = 150 \text{ }^\circ\text{C}$	2	mA	

Table 5. Thermal resistance

Symbol	Parameter	Value	Unit
$R_{th(j-c)}$	Junction to case (AC)	1.0	$^\circ\text{C/W}$
$R_{th(j-a)}$	Junction to ambient (AC)	60	$^\circ\text{C/W}$

Figure 1. Maximum power dissipation versus average on-state current (full cycle)

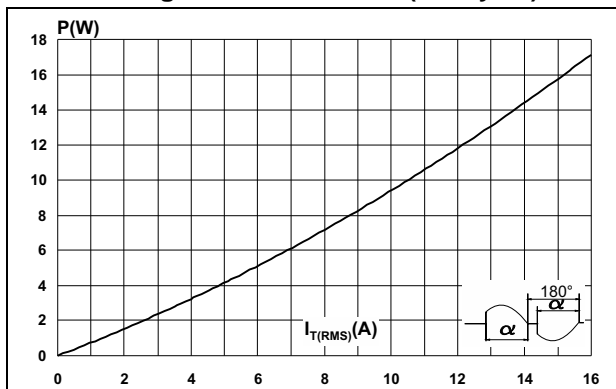

Figure 2. On-state rms current versus case temperature (full cycle)

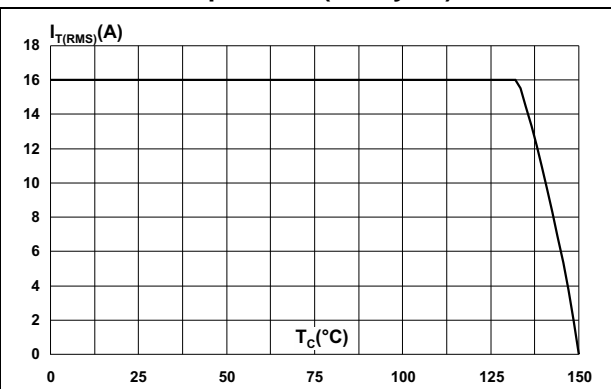

Figure 3. On-state rms current versus ambient temperature (free air convection)

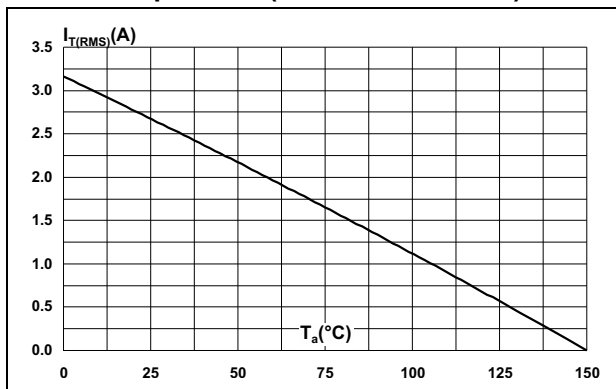

Figure 4. Relative variation of thermal impedance versus pulse duration

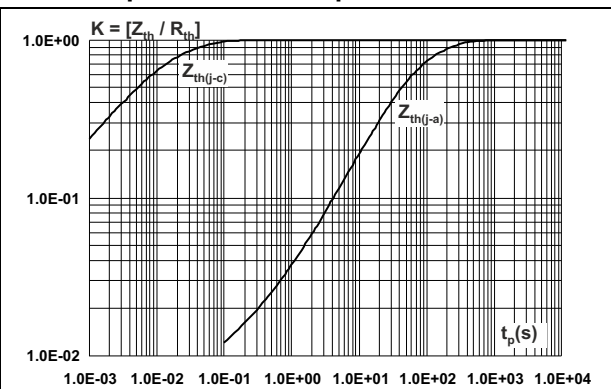

Figure 5. Relative variation of gate trigger current and voltage versus junction temperature (typical values)

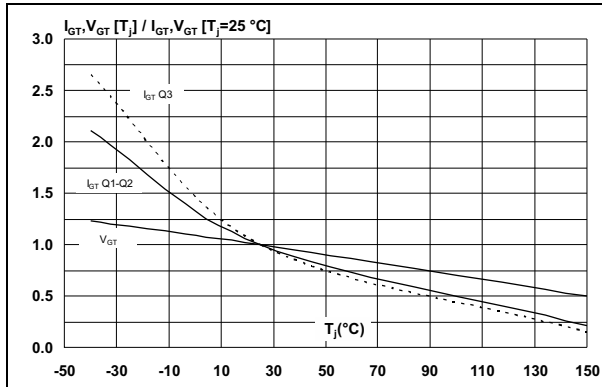

Figure 6. Relative variation of holding and latching current versus junction temperature (typical values)

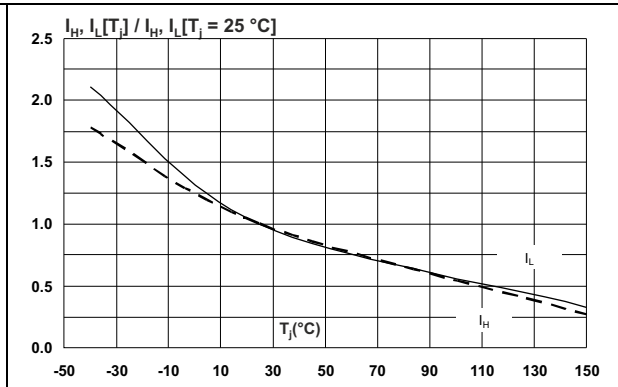

Figure 7. Relative variation of dV/dt immunity versus junction temperature (typical values)

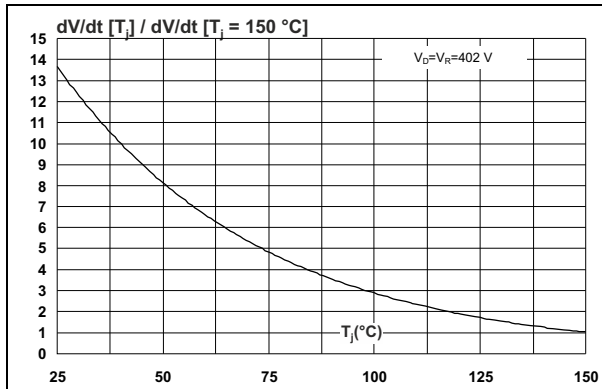

Figure 8. Relative variation of critical rate of decrease of main current (di/dt)c versus junction temperature (typical values)

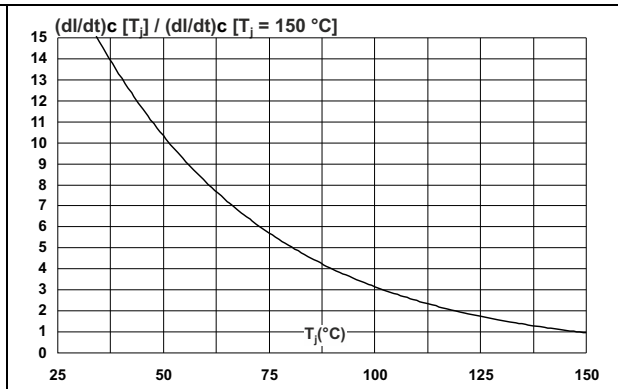

Figure 9. Relative variation of critical rate of decrease of main current (di/dt)c versus reapplied (dV/dt)c

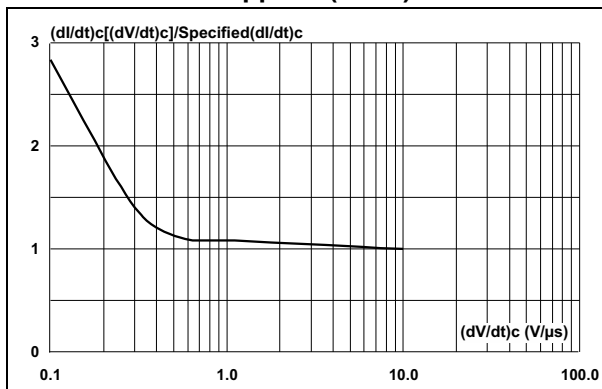

Figure 10. Surge peak on-state current versus number of cycles

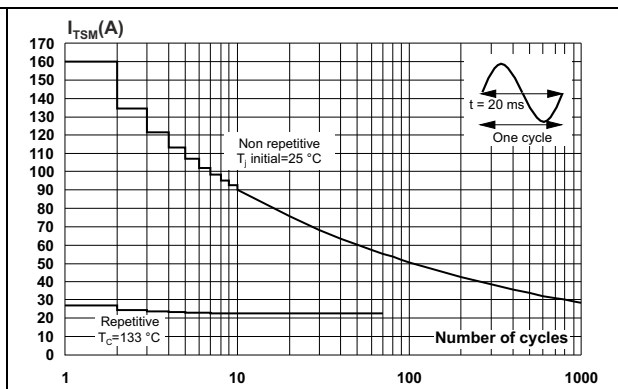

Figure 11. Non repetitive surge peak on-state current for a sinusoidal pulse with width  $t_p < 10$  ms, and corresponding value of  $I^2t$

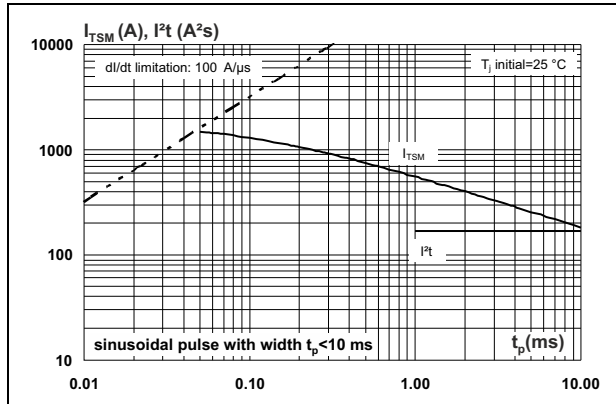

Figure 12. On-state characteristics (maximum values)

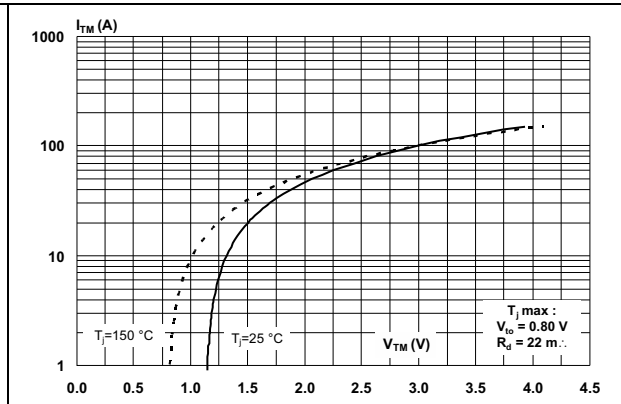
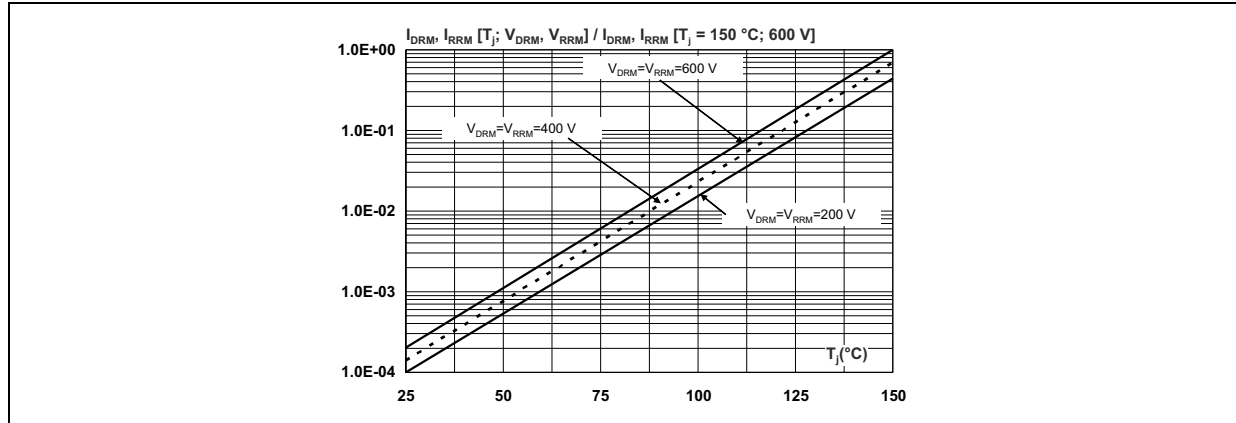

Figure 13. Relative variation of leakage current versus junction temperature for different values of blocking voltage (typical values)



## 2 Package information

- Epoxy meets UL94, V0
- Recommended torque value: 0.4 to 0.6 N·m

In order to meet environmental requirements, ST offers these devices in different grades of ECOPACK<sup>®</sup> packages, depending on their level of environmental compliance. ECOPACK<sup>®</sup> specifications, grade definitions and product status are available at: [www.st.com](http://www.st.com). ECOPACK<sup>®</sup> is an ST trademark.

Figure 14. TO-220AB dimension definitions

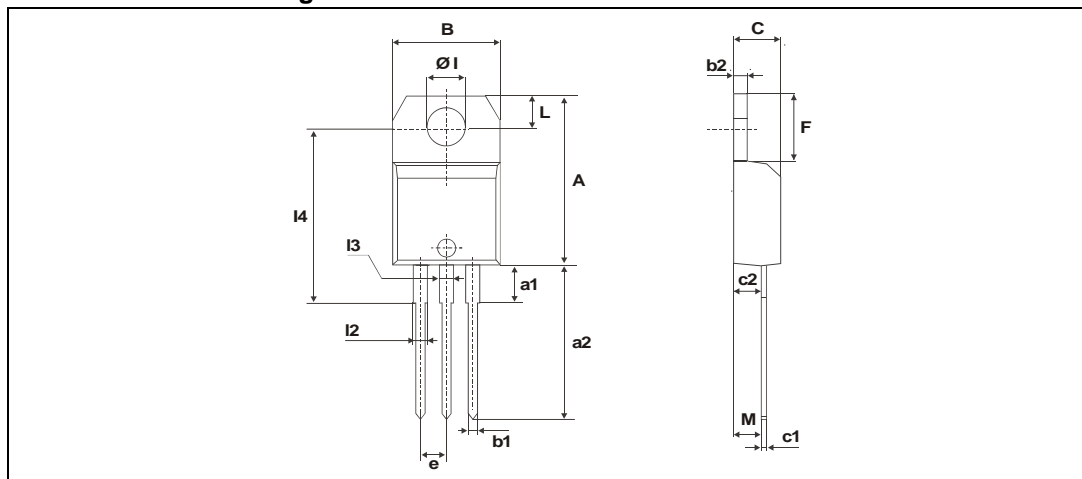

Table 6. TO-220AB dimension values

Ref.	Dimensions					
	Millimeters			Inches		
	Min.	Typ.	Max.	Min.	Typ.	Max.
A	15.20		15.90	0.598		0.625
a1		3.75			0.147	
a2	13.00		14.00	0.511		0.551
B	10.00		10.40	0.393		0.409
b1	0.61		0.88	0.024		0.034
b2	1.23		1.32	0.048		0.051
C	4.40		4.60	0.173		0.181
c1	0.49		0.70	0.019		0.027
c2	2.40		2.72	0.094		0.107
e	2.40		2.70	0.094		0.106
F	6.20		6.60	0.244		0.259
ØI	3.75		3.85	0.147		0.151
I4	15.80	16.40	16.80	0.622	0.646	0.661
L	2.65		2.95	0.104		0.116
I2	1.14		1.70	0.044		0.066
I3	1.14		1.70	0.044		0.066
M		2.60			0.102	

### 3 Ordering information

Figure 15. Ordering information scheme

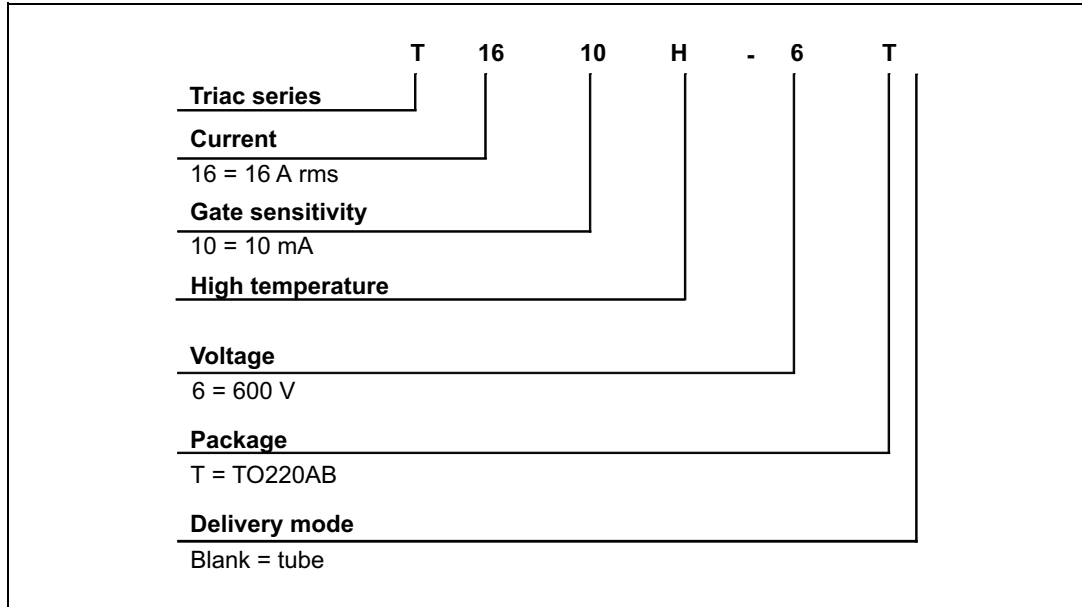

Table 7. Ordering information

Order code	Marking	Package	Weight	Base qty	Delivery mode
T1610H-6T	T1610H-6T	TO-220AB	2.3	50	Tube

### 4 Revision history

Table 8. Document revision history

Date	Revision	Changes
31-May-2013	1	First issue.



**Please Read Carefully:**

Information in this document is provided solely in connection with ST products. STMicroelectronics NV and its subsidiaries ("ST") reserve the right to make changes, corrections, modifications or improvements, to this document, and the products and services described herein at any time, without notice.

All ST products are sold pursuant to ST's terms and conditions of sale.

Purchasers are solely responsible for the choice, selection and use of the ST products and services described herein, and ST assumes no liability whatsoever relating to the choice, selection or use of the ST products and services described herein.

No license, express or implied, by estoppel or otherwise, to any intellectual property rights is granted under this document. If any part of this document refers to any third party products or services it shall not be deemed a license grant by ST for the use of such third party products or services, or any intellectual property contained therein or considered as a warranty covering the use in any manner whatsoever of such third party products or services or any intellectual property contained therein.

**UNLESS OTHERWISE SET FORTH IN ST'S TERMS AND CONDITIONS OF SALE ST DISCLAIMS ANY EXPRESS OR IMPLIED WARRANTY WITH RESPECT TO THE USE AND/OR SALE OF ST PRODUCTS INCLUDING WITHOUT LIMITATION IMPLIED WARRANTIES OF MERCHANTABILITY, FITNESS FOR A PARTICULAR PURPOSE (AND THEIR EQUIVALENTS UNDER THE LAWS OF ANY JURISDICTION), OR INFRINGEMENT OF ANY PATENT, COPYRIGHT OR OTHER INTELLECTUAL PROPERTY RIGHT.**

**ST PRODUCTS ARE NOT AUTHORIZED FOR USE IN WEAPONS. NOR ARE ST PRODUCTS DESIGNED OR AUTHORIZED FOR USE IN: (A) SAFETY CRITICAL APPLICATIONS SUCH AS LIFE SUPPORTING, ACTIVE IMPLANTED DEVICES OR SYSTEMS WITH PRODUCT FUNCTIONAL SAFETY REQUIREMENTS; (B) AERONAUTIC APPLICATIONS; (C) AUTOMOTIVE APPLICATIONS OR ENVIRONMENTS, AND/OR (D) AEROSPACE APPLICATIONS OR ENVIRONMENTS. WHERE ST PRODUCTS ARE NOT DESIGNED FOR SUCH USE, THE PURCHASER SHALL USE PRODUCTS AT PURCHASER'S SOLE RISK, EVEN IF ST HAS BEEN INFORMED IN WRITING OF SUCH USAGE, UNLESS A PRODUCT IS EXPRESSLY DESIGNATED BY ST AS BEING INTENDED FOR "AUTOMOTIVE, AUTOMOTIVE SAFETY OR MEDICAL" INDUSTRY DOMAINS ACCORDING TO ST PRODUCT DESIGN SPECIFICATIONS. PRODUCTS FORMALLY ESCC, QML OR JAN QUALIFIED ARE DEEMED SUITABLE FOR USE IN AEROSPACE BY THE CORRESPONDING GOVERNMENTAL AGENCY.**

Resale of ST products with provisions different from the statements and/or technical features set forth in this document shall immediately void any warranty granted by ST for the ST product or service described herein and shall not create or extend in any manner whatsoever, any liability of ST.

ST and the ST logo are trademarks or registered trademarks of ST in various countries.

Information in this document supersedes and replaces all information previously supplied.

The ST logo is a registered trademark of STMicroelectronics. All other names are the property of their respective owners.

© 2013 STMicroelectronics - All rights reserved

STMicroelectronics group of companies

Australia - Belgium - Brazil - Canada - China - Czech Republic - Finland - France - Germany - Hong Kong - India - Israel - Italy - Japan - Malaysia - Malta - Morocco - Philippines - Singapore - Spain - Sweden - Switzerland - United Kingdom - United States of America

[www.st.com](http://www.st.com)

