

# General Purpose Transistors

## NPN Silicon

### BC817-16L, SBC817-16L, BC817-25L, SBC817-25L, BC817-40L, SBC817-40L

#### Features

- S and NSV Prefixes for Automotive and Other Applications Requiring Unique Site and Control Change Requirements; AEC-Q101 Qualified and PPAP Capable
- These Devices are Pb-Free, Halogen Free/BFR Free and are RoHS Compliant

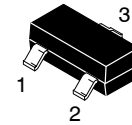
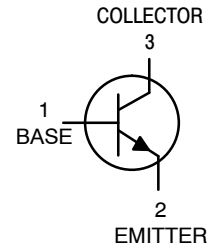

SOT-23  
CASE 318  
STYLE 6

#### MAXIMUM RATINGS

Rating	Symbol	Value	Unit
Collector – Emitter Voltage	$V_{CEO}$	45	V
Collector – Base Voltage	$V_{CBO}$	50	V
Emitter – Base Voltage	$V_{EBO}$	5.0	V
Collector Current – Continuous	$I_C$	500	mAdc

#### THERMAL CHARACTERISTICS

Characteristic	Symbol	Max	Unit
Total Device Dissipation FR-5 Board, (Note 1) $T_A = 25^\circ\text{C}$ Derate above $25^\circ\text{C}$	$P_D$	225 1.8	mW mW/ $^\circ\text{C}$
Thermal Resistance, Junction-to-Ambient	$R_{\theta JA}$	556	$^\circ\text{C}/\text{W}$
Total Device Dissipation Alumina Substrate, (Note 2) $T_A = 25^\circ\text{C}$ Derate above $25^\circ\text{C}$	$P_D$	300 2.4	mW mW/ $^\circ\text{C}$
Thermal Resistance, Junction-to-Ambient	$R_{\theta JA}$	417	$^\circ\text{C}/\text{W}$
Junction and Storage Temperature	$T_J, T_{stg}$	-65 to +150	$^\circ\text{C}$

Stresses exceeding those listed in the Maximum Ratings table may damage the device. If any of these limits are exceeded, device functionality should not be assumed, damage may occur and reliability may be affected.

1. FR-5 = 1.0 x 0.75 x 0.062 in.
2. Alumina = 0.4 x 0.3 x 0.024 in 99.5% alumina.

#### MARKING DIAGRAM

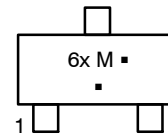

- 6x = Device Code  
x = A, B, or C  
M = Date Code\*  
▪ = Pb-Free Package

(Note: Microdot may be in either location)  
\*Date Code orientation and/or overbar may vary depending upon manufacturing location.

#### ORDERING INFORMATION

See detailed ordering and shipping information in the package dimensions section on page 2 of this data sheet.

# BC817-16L, SBC817-16L, BC817-25L, SBC817-25L, BC817-40L, SBC817-40L

## ELECTRICAL CHARACTERISTICS (T<sub>A</sub> = 25°C unless otherwise noted)

Characteristic	Symbol	Min	Typ	Max	Unit
<b>OFF CHARACTERISTICS</b>					
Collector - Emitter Breakdown Voltage (I <sub>C</sub> = 10 mA)	V <sub>(BR)CEO</sub>	45	-	-	V
Collector - Emitter Breakdown Voltage (V <sub>EB</sub> = 0, I <sub>C</sub> = 10 μA)	V <sub>(BR)CES</sub>	50	-	-	V
Emitter - Base Breakdown Voltage (I <sub>E</sub> = 1.0 μA)	V <sub>(BR)EBO</sub>	5.0	-	-	V
Collector Cutoff Current (V <sub>CB</sub> = 20 V) (V <sub>CB</sub> = 20 V, T <sub>A</sub> = 150°C)	I <sub>CBO</sub>	-	-	100 5.0	nA μA

## ON CHARACTERISTICS

DC Current Gain (I <sub>C</sub> = 100 mA, V <sub>CE</sub> = 1.0 V)	BC817-16, SBC817-16 BC817-25, SBC817-25 BC817-40, SBC817-40	h <sub>FE</sub>	100	-	250	-
(I <sub>C</sub> = 500 mA, V <sub>CE</sub> = 1.0 V)			160	-	400	
			250	-	600	
			40	-	-	
Collector - Emitter Saturation Voltage (I <sub>C</sub> = 500 mA, I <sub>B</sub> = 50 mA)	V <sub>CE(sat)</sub>	-	-	0.7	V	
Base - Emitter On Voltage (I <sub>C</sub> = 500 mA, V <sub>CE</sub> = 1.0 V)	V <sub>BE(on)</sub>	-	-	1.2	V	

## SMALL-SIGNAL CHARACTERISTICS

Current - Gain - Bandwidth Product (I <sub>C</sub> = 10 mA, V <sub>CE</sub> = 5.0 Vdc, f = 100 MHz)	f <sub>T</sub>	100	-	-	MHz
Output Capacitance (V <sub>CB</sub> = 10 V, f = 1.0 MHz)	C <sub>obo</sub>	-	10	-	pF

Product parametric performance is indicated in the Electrical Characteristics for the listed test conditions, unless otherwise noted. Product performance may not be indicated by the Electrical Characteristics if operated under different conditions.

## ORDERING INFORMATION

Device	Specific Marking	Package	Shipping <sup>†</sup>
BC817-16LT1G	6A	SOT-23 (Pb-Free)	3000 / Tape & Reel
NSVBC817-16LT1G			10,000 / Tape & Reel
BC817-16LT3G			
SBC817-16LT3G			
BC817-25LT1G	6B	SOT-23 (Pb-Free)	3000 / Tape & Reel
SBC817-25LT1G			10,000 / Tape & Reel
BC817-25LT3G			
SBC817-25LT3G			
BC817-40LT1G	6C	SOT-23 (Pb-Free)	3000 / Tape & Reel
SBC817-40LT1G			10,000 / Tape & Reel
BC817-40LT3G			
SBC817-40LT3G			

<sup>†</sup>For information on tape and reel specifications, including part orientation and tape sizes, please refer to our Tape and Reel Packaging Specifications Brochure, BRD8011/D.

TYPICAL CHARACTERISTICS - BC817-16L, SBC817-16L

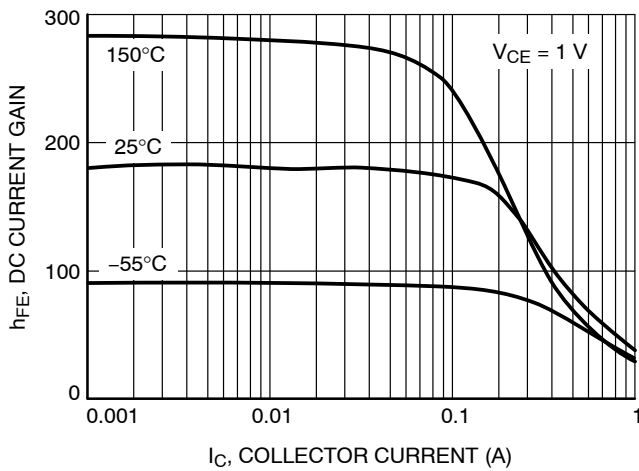

Figure 1. DC Current Gain vs. Collector Current

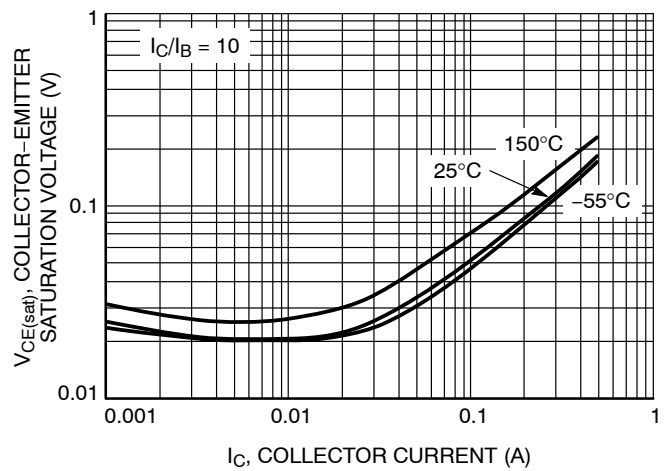

Figure 2. Collector Emitter Saturation Voltage vs. Collector Current

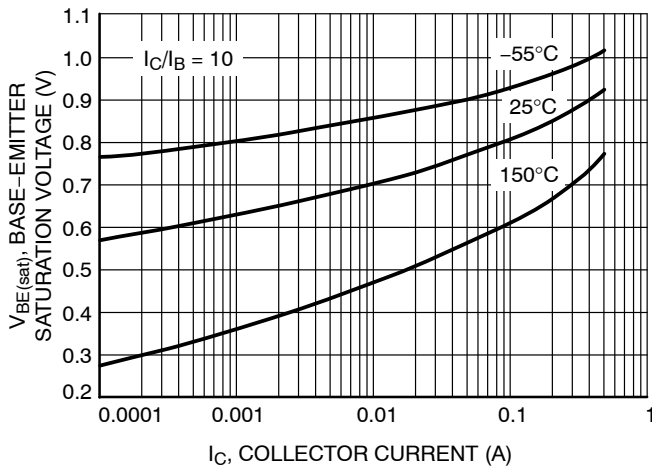

Figure 3. Base Emitter Saturation Voltage vs. Collector Current

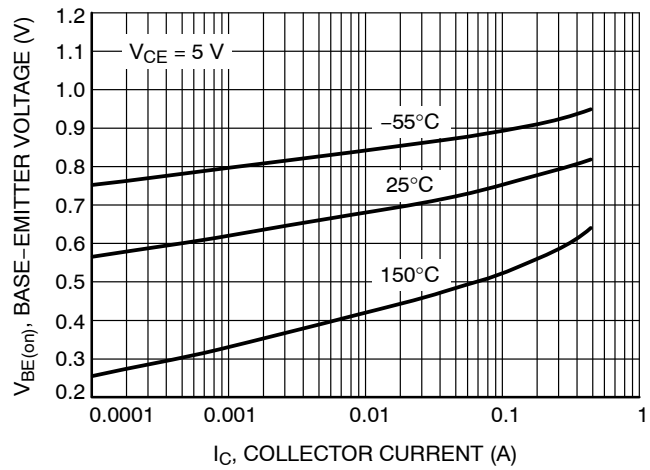

Figure 4. Base Emitter Voltage vs. Collector Current

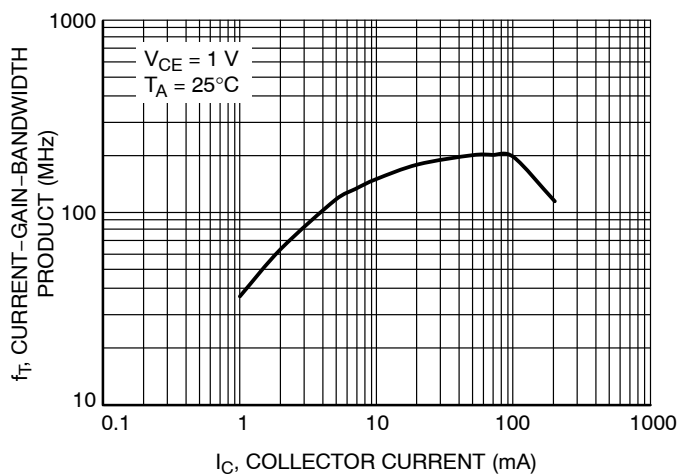

Figure 5. Current Gain Bandwidth Product vs. Collector Current

TYPICAL CHARACTERISTICS - BC817-16L, SBC817-16L

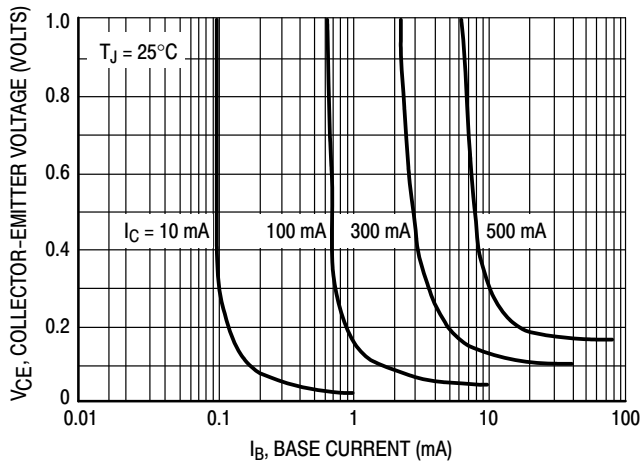

Figure 6. Saturation Region



Figure 7. Temperature Coefficients

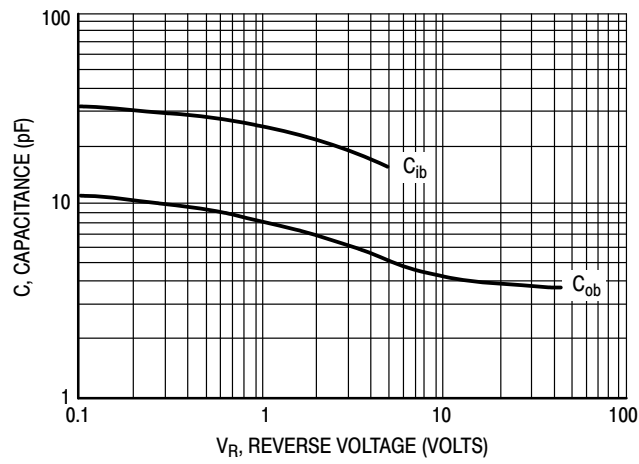

Figure 8. Capacitances

TYPICAL CHARACTERISTICS - BC817-25L, SBC817-25L

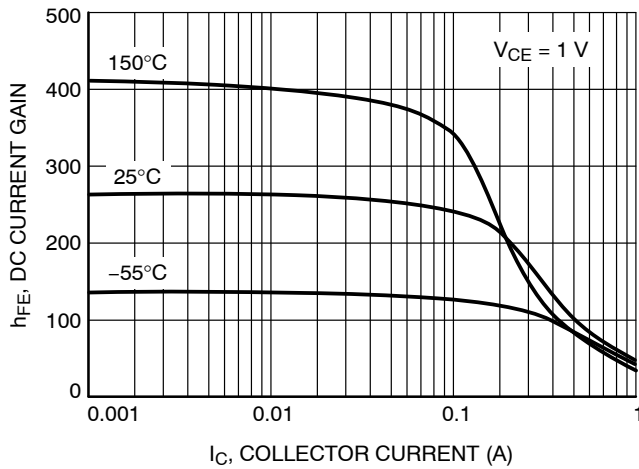

Figure 9. DC Current Gain vs. Collector Current

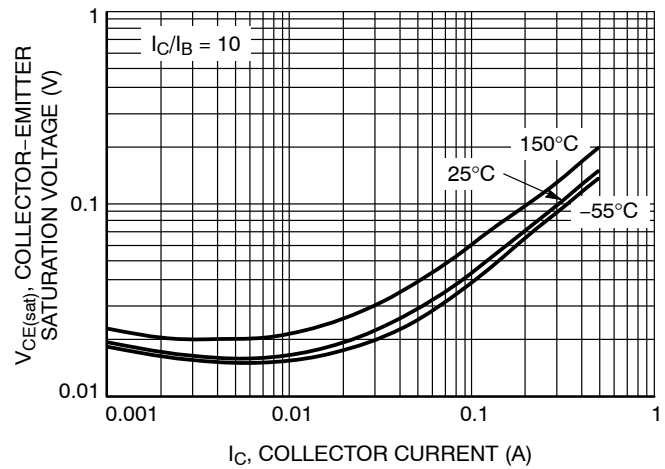

Figure 10. Collector Emitter Saturation Voltage vs. Collector Current



Figure 11. Base Emitter Saturation Voltage vs. Collector Current



Figure 12. Base Emitter Voltage vs. Collector Current

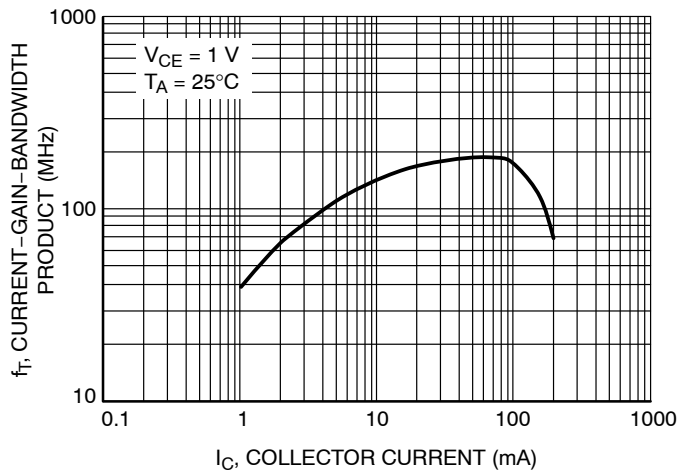

Figure 13. Current Gain Bandwidth Product vs. Collector Current

TYPICAL CHARACTERISTICS - BC817-25L, SBC81725L

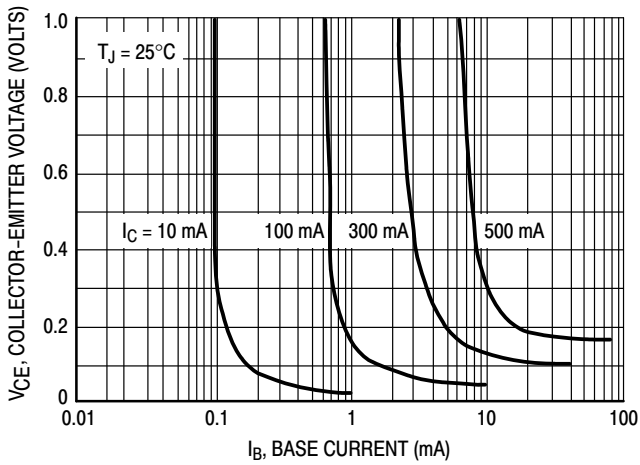

Figure 14. Saturation Region

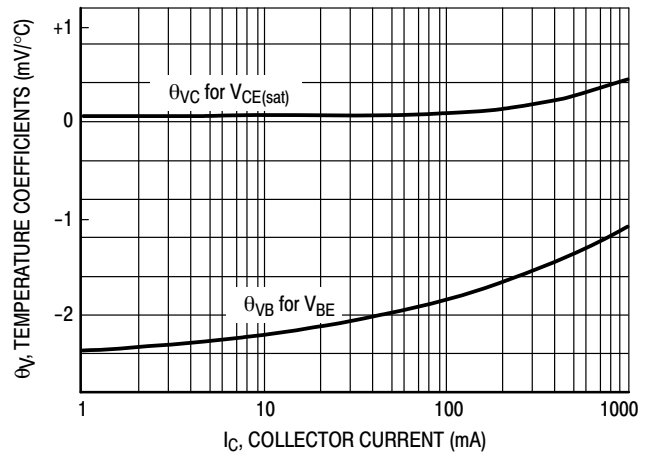

Figure 15. Temperature Coefficients



Figure 16. Capacitances

TYPICAL CHARACTERISTICS - BC817-40L, SBC817-40L



Figure 17. DC Current Gain vs. Collector Current

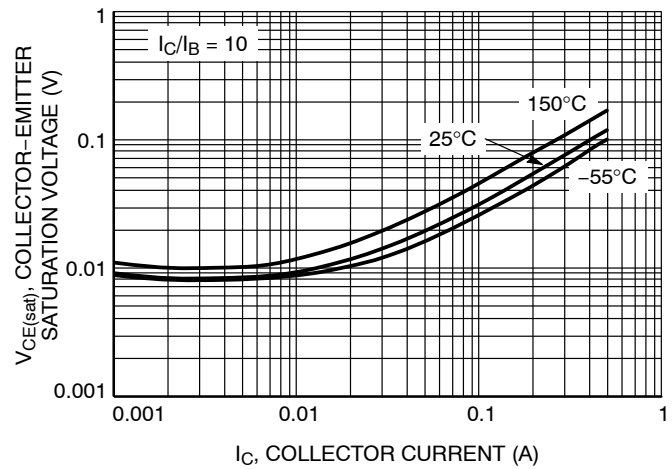

Figure 18. Collector Emitter Saturation Voltage vs. Collector Current



Figure 19. Base Emitter Saturation Voltage vs. Collector Current

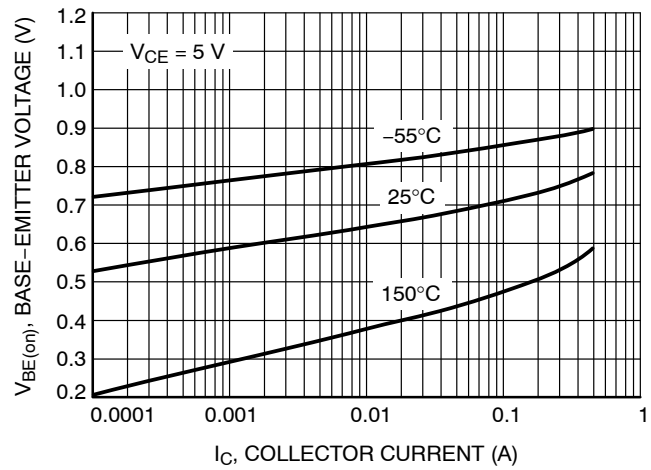

Figure 20. Base Emitter Voltage vs. Collector Current

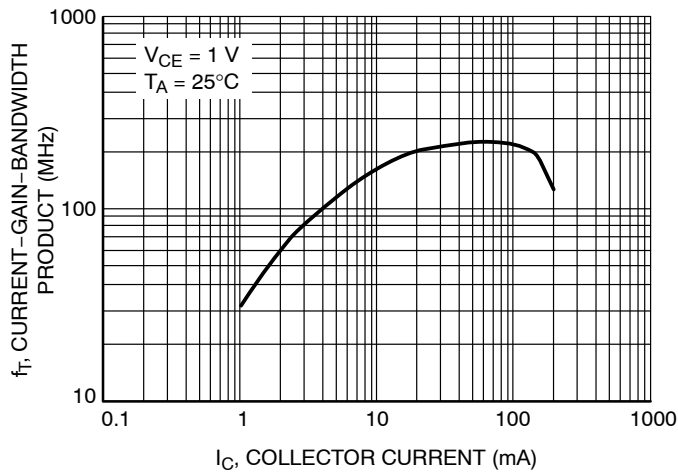

Figure 21. Current Gain Bandwidth Product vs. Collector Current

TYPICAL CHARACTERISTICS - BC817-40L, SBC817-40L

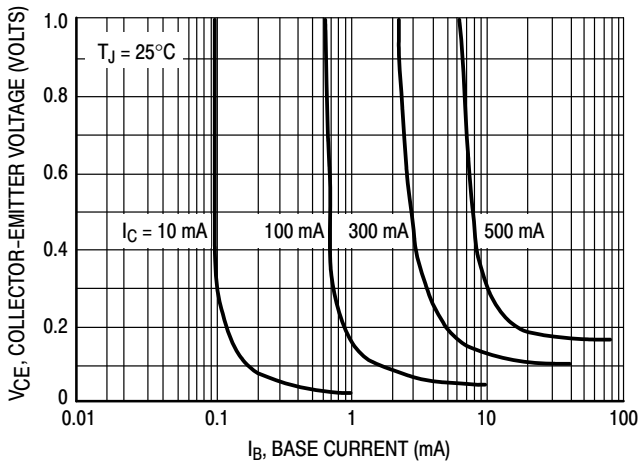

Figure 22. Saturation Region

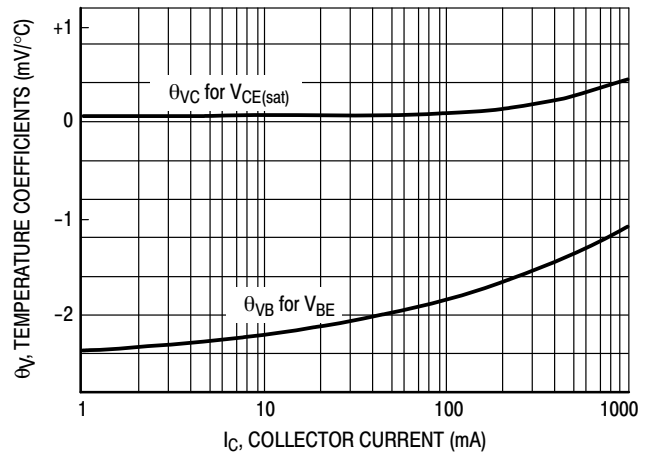

Figure 23. Temperature Coefficients

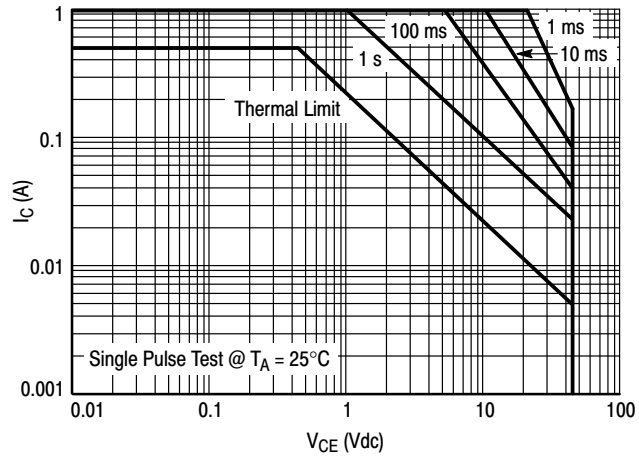

Figure 24. Capacitances



**BC817-16L, SBC817-16L, BC817-25L, SBC817-25L, BC817-40L, SBC817-40L**

**TYPICAL CHARACTERISTICS - BC817-16L, SBC817-16L, BC817-25L, SBC817-25L, BC817-40L, SBC817-40L**

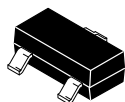

**Figure 25. Safe Operating Area**

# MECHANICAL CASE OUTLINE

## PACKAGE DIMENSIONS

ON Semiconductor®



SOT-23 (TO-236)  
CASE 318-08  
ISSUE AS

DATE 30 JAN 2018

SCALE 4:1

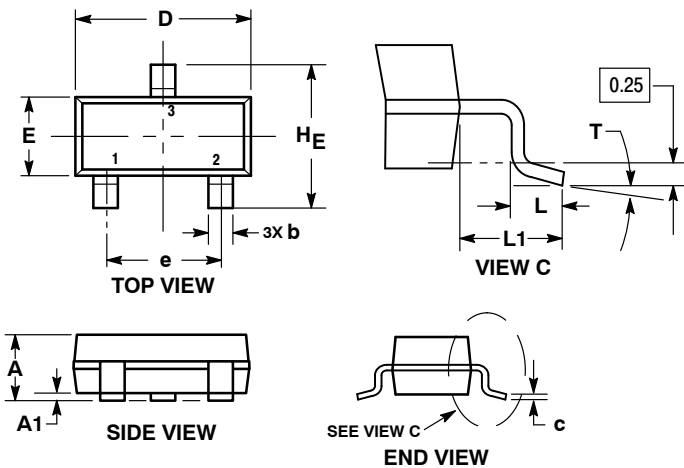

NOTES:

1. DIMENSIONING AND TOLERANCING PER ASME Y14.5M, 1994.
2. CONTROLLING DIMENSION: MILLIMETERS.
3. MAXIMUM LEAD THICKNESS INCLUDES LEAD FINISH. MINIMUM LEAD THICKNESS IS THE MINIMUM THICKNESS OF THE BASE MATERIAL.
4. DIMENSIONS D AND E DO NOT INCLUDE MOLD FLASH, PROTRUSIONS, OR GATE BURRS.

DIM	MILLIMETERS			INCHES		
	MIN	NOM	MAX	MIN	NOM	MAX
A	0.89	1.00	1.11	0.035	0.039	0.044
A1	0.01	0.06	0.10	0.000	0.002	0.004
b	0.37	0.44	0.50	0.015	0.017	0.020
c	0.08	0.14	0.20	0.003	0.006	0.008
D	2.80	2.90	3.04	0.110	0.114	0.120
E	1.20	1.30	1.40	0.047	0.051	0.055
e	1.78	1.90	2.04	0.070	0.075	0.080
L	0.30	0.43	0.55	0.012	0.017	0.022
L1	0.35	0.54	0.69	0.014	0.021	0.027
HE	2.10	2.40	2.64	0.083	0.094	0.104
T	0°	---	10°	0°	---	10°

### RECOMMENDED SOLDERING FOOTPRINT

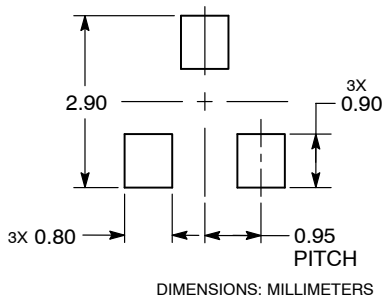

### GENERIC MARKING DIAGRAM\*

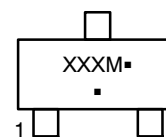

XXX = Specific Device Code  
M = Date Code  
▪ = Pb-Free Package

\*This information is generic. Please refer to device data sheet for actual part marking. Pb-Free indicator, "G" or microdot "▪", may or may not be present.

STYLE 1 THRU 5:  
CANCELLED

STYLE 6:  
PIN 1. BASE  
2. EMITTER  
3. COLLECTOR

STYLE 7:  
PIN 1. EMITTER  
2. BASE  
3. COLLECTOR

STYLE 8:  
PIN 1. ANODE  
2. NO CONNECTION  
3. CATHODE

STYLE 9:  
PIN 1. ANODE  
2. ANODE  
3. CATHODE

STYLE 10:  
PIN 1. DRAIN  
2. SOURCE  
3. GATE

STYLE 11:  
PIN 1. ANODE  
2. CATHODE  
3. CATHODE-ANODE

STYLE 12:  
PIN 1. CATHODE  
2. CATHODE  
3. ANODE

STYLE 13:  
PIN 1. SOURCE  
2. DRAIN  
3. GATE

STYLE 14:  
PIN 1. CATHODE  
2. GATE  
3. ANODE

STYLE 15:  
PIN 1. GATE  
2. CATHODE  
3. ANODE

STYLE 16:  
PIN 1. ANODE  
2. CATHODE  
3. CATHODE

STYLE 17:  
PIN 1. NO CONNECTION  
2. ANODE  
3. CATHODE

STYLE 18:  
PIN 1. NO CONNECTION  
2. CATHODE  
3. ANODE

STYLE 19:  
PIN 1. CATHODE  
2. ANODE  
3. CATHODE-ANODE

STYLE 20:  
PIN 1. CATHODE  
2. ANODE  
3. GATE

STYLE 21:  
PIN 1. GATE  
2. SOURCE  
3. DRAIN

STYLE 22:  
PIN 1. RETURN  
2. OUTPUT  
3. INPUT

STYLE 23:  
PIN 1. ANODE  
2. ANODE  
3. CATHODE

STYLE 24:  
PIN 1. GATE  
2. DRAIN  
3. SOURCE

STYLE 25:  
PIN 1. ANODE  
2. CATHODE  
3. GATE

STYLE 26:  
PIN 1. CATHODE  
2. ANODE  
3. NO CONNECTION

STYLE 27:  
PIN 1. CATHODE  
2. CATHODE  
3. CATHODE

STYLE 28:  
PIN 1. ANODE  
2. ANODE  
3. ANODE

<b>DOCUMENT NUMBER:</b>	<b>98ASB42226B</b>	Electronic versions are uncontrolled except when accessed directly from the Document Repository. Printed versions are uncontrolled except when stamped "CONTROLLED COPY" in red.
<b>DESCRIPTION:</b>	<b>SOT-23 (TO-236)</b>	<b>PAGE 1 OF 1</b>

ON Semiconductor and ON are trademarks of Semiconductor Components Industries, LLC dba ON Semiconductor or its subsidiaries in the United States and/or other countries. ON Semiconductor reserves the right to make changes without further notice to any products herein. ON Semiconductor makes no warranty, representation or guarantee regarding the suitability of its products for any particular purpose, nor does ON Semiconductor assume any liability arising out of the application or use of any product or circuit, and specifically disclaims any and all liability, including without limitation special, consequential or incidental damages. ON Semiconductor does not convey any license under its patent rights nor the rights of others.

**onsemi**, **Onsemi**, and other names, marks, and brands are registered and/or common law trademarks of Semiconductor Components Industries, LLC dba "**onsemi**" or its affiliates and/or subsidiaries in the United States and/or other countries. **onsemi** owns the rights to a number of patents, trademarks, copyrights, trade secrets, and other intellectual property. A listing of **onsemi**'s product/patent coverage may be accessed at [www.onsemi.com/site/pdf/Patent-Marking.pdf](http://www.onsemi.com/site/pdf/Patent-Marking.pdf). **onsemi** reserves the right to make changes at any time to any products or information herein, without notice. The information herein is provided "as-is" and **onsemi** makes no warranty, representation or guarantee regarding the accuracy of the information, product features, availability, functionality, or suitability of its products for any particular purpose, nor does **onsemi** assume any liability arising out of the application or use of any product or circuit, and specifically disclaims any and all liability, including without limitation special, consequential or incidental damages. Buyer is responsible for its products and applications using **onsemi** products, including compliance with all laws, regulations and safety requirements or standards, regardless of any support or applications information provided by **onsemi**. "Typical" parameters which may be provided in **onsemi** data sheets and/or specifications can and do vary in different applications and actual performance may vary over time. All operating parameters, including "Typicals" must be validated for each customer application by customer's technical experts. **onsemi** does not convey any license under any of its intellectual property rights nor the rights of others. **onsemi** products are not designed, intended, or authorized for use as a critical component in life support systems or any FDA Class 3 medical devices or medical devices with a same or similar classification in a foreign jurisdiction or any devices intended for implantation in the human body. Should Buyer purchase or use **onsemi** products for any such unintended or unauthorized application, Buyer shall indemnify and hold **onsemi** and its officers, employees, subsidiaries, affiliates, and distributors harmless against all claims, costs, damages, and expenses, and reasonable attorney fees arising out of, directly or indirectly, any claim of personal injury or death associated with such unintended or unauthorized use, even if such claim alleges that **onsemi** was negligent regarding the design or manufacture of the part. **onsemi** is an Equal Opportunity/Affirmative Action Employer. This literature is subject to all applicable copyright laws and is not for resale in any manner.

## PUBLICATION ORDERING INFORMATION

### LITERATURE FULFILLMENT:

Email Requests to: [orderlit@onsemi.com](mailto:orderlit@onsemi.com)

**onsemi Website:** [www.onsemi.com](http://www.onsemi.com)

### TECHNICAL SUPPORT

**North American Technical Support:**

Voice Mail: 1 800-282-9855 Toll Free USA/Canada

Phone: 011 421 33 790 2910

**Europe, Middle East and Africa Technical Support:**

Phone: 00421 33 790 2910

For additional information, please contact your local Sales Representative

