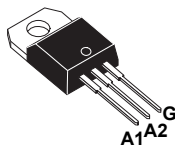

## 16 A Triac for LED light dimmer

**TO-220AB Ins.**

### Features

- Three quadrants with logic level gate
- Benefits:
  - Super low holding current  $I_H = 5 \text{ mA}$
  - Optimized thermal performance with low power dissipation
  - Optimized turn-off commutation for lighting loads

### Application

- Lighting:
  - Universal light dimmers
  - LED light dimmers
- Heating
- Overvoltage crowbar protection

### Description

The T1605G-6I Triac in TO-220AB insulated can be used for the on/off or phase angle control function in general purpose AC switching where high commutation capability is required.

Its super low holding current  $I_H$  enables deep dimming for LED light dimmers without flickering nor jittering.

Package environmentally friendly **ECOPACK2**, RoHS (2011/65/EU) and halogen free compliant.

TO-220AB insulated package is UL-94, V0 flammability resin compliance.

This component is recognized by UL. Representative samples of this component have been evaluated by UL and meet applicable UL requirements for UL 1557 standard (File Ref. 81734).

#### Product status link

[T1605G-6I](#)

#### Product summary

<b>Order code</b>	T1605G-6I
<b>Package</b>	TO-220AB Ins.
<b><math>V_{DRM}/V_{RRM}</math></b>	600 V
<b><math>I_{GT}</math></b>	5 mA
<b><math>I_H</math></b>	5 mA

# 1 Characteristics

**Table 1. Absolute maximum ratings (limiting values)**

Symbol	Parameters		Value	Unit	
$I_{T(RMS)}$	RMS on-state current (full sine wave)	$T_c = 85\text{ °C}$	16	A	
$I_{TSM}$	Non repetitive surge peak on-state current, (full cycle, $T_j$ initial = 25 °C)	$t_p = 16.7\text{ ms}$	$T_j = 25\text{ °C}$	140	A
		$t_p = 20\text{ ms}$	$T_j = 25\text{ °C}$	132	
$I^2t$	$I^2t$ value for fusing	$t_p = 10\text{ ms}$	$T_j = 25\text{ °C}$	116	A <sup>2</sup> s
$di/dt$	Critical rate of rise of on-state current $I_G = 2 \times I_{GT}$ , $t_r \leq 100\text{ ns}$	$f = 50\text{ Hz}$	$T_j = 25\text{ °C}$	50	A/ $\mu$ s
$V_{DRM}/V_{RRM}$	Repetitive peak off-state voltage		$T_j = 125\text{ °C}$	600	V
$V_{DSM}/V_{RSM}$	Non repetitive surge peak off-state voltage	$t_p = 20\text{ ms}$	$T_j = 25\text{ °C}$	700	V
$I_{GM}$	Peak gate current	$t_p = 20\text{ }\mu$ s	$T_j = 125\text{ °C}$	4	A
$P_{G(AV)}$	Average gate power dissipation		$T_j = 125\text{ °C}$	1	W
$T_{stg}$	Storage junction temperature range			-40 to +150	°C
$T_j$	Operating junction temperature range			-40 to +125	°C

**Table 2. Electrical characteristics ( $T_j = 25\text{ °C}$ , unless otherwise specified)**

Symbol	Parameters	Quadrant		Value	Unit
$I_{GT}$	$V_D = 12\text{ V}$ , $R_L = 33\text{ }\Omega$	I - II - III	Min.	0.25	mA
			Max.	5	
$V_{GT}$			Max.	1.3	V
$V_{GD}$	$V_D = V_{DRM}$ , $R_L = 3.3\text{ k}\Omega$ , $T_j = 125\text{ °C}$	I - II - III	Min.	0.2	V
$I_H^{(1)}$	$I_T = 500\text{ mA}$ , gate open		Max.	5	mA
$I_L$	$I_G = 1.2 I_{GT}$	I - III	Max.	10	mA
		II	Max.	15	
$dV/dt^{(1)}$	$V_D = 67\% V_{DRM}$ , gate open	$T_j = 125\text{ °C}$	Min.	10	V/ $\mu$ s
$(di/dt)^c^{(1)}$	$(dV/dt)^c = 0.1\text{ V}/\mu$ s	$T_j = 125\text{ °C}$	Min.	2.5	A/ms

1. For both polarities of A2 referenced to A1

**Table 3. Static electrical characteristics**

Symbol	Test conditions	$T_j$		Value	Unit
$V_{TM}^{(1)}$	$I_{TM} = 22.5\text{ A}$ , $t_p = 380\text{ }\mu$ s	25 °C	Max.	1.55	V
$V_{TO}^{(1)}$	threshold on-state voltage	125 °C	Max.	0.83	V
$R_D^{(1)}$	Dynamic resistance	125 °C	Max.	28	m $\Omega$
$I_{DRM}/I_{RRM}$	$V_{DRM} = V_{RRM} = 600\text{ V}$	25 °C	Max.	5	$\mu$ A
		125 °C		1	mA

1. For both polarities of A2 referenced to A1

**Table 4. Thermal resistance**

Symbol	Parameters		Value	Unit
$R_{th(j-c)}$	Max. junction to case (AC)	Max.	2.1	°C/W
$R_{th(j-a)}$	Junction to ambient	Typ.	60	

## 1.1 Characteristics (curves)

**Figure 1. Maximum power dissipation versus on-state RMS current (full cycle)**

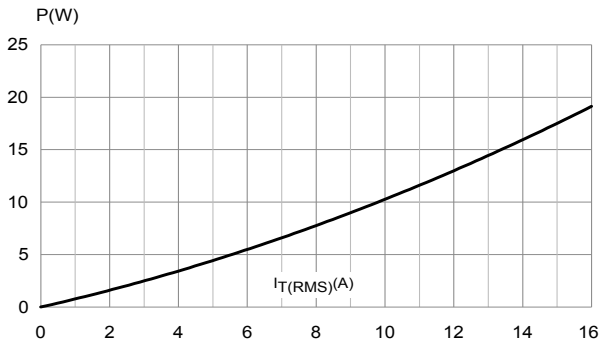

**Figure 2. RMS on-state current versus case temperature (full cycle)**

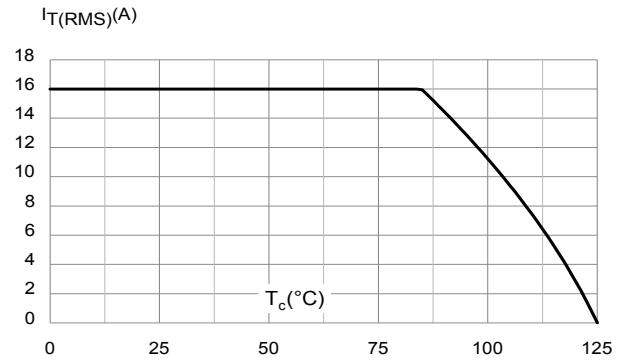

**Figure 3. Relative variation of thermal impedance versus pulse duration**

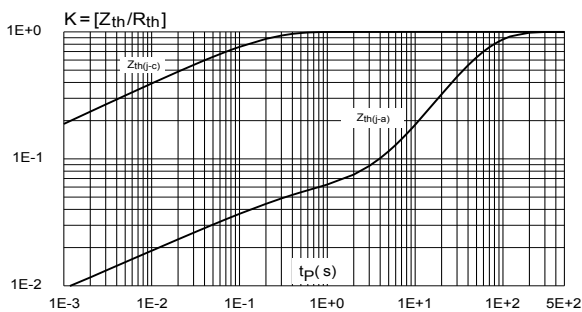

**Figure 4. On-state characteristics (maximum values)**

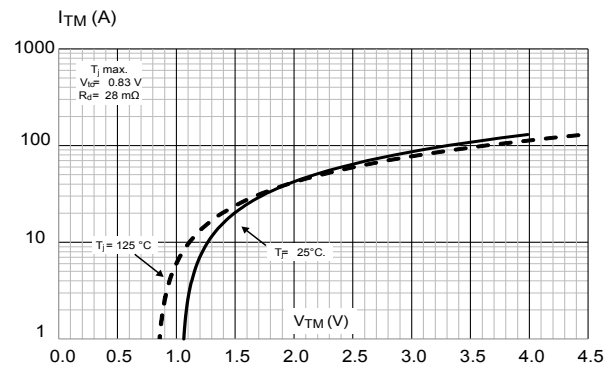

**Figure 5. Surge peak on-state current versus number of cycles**

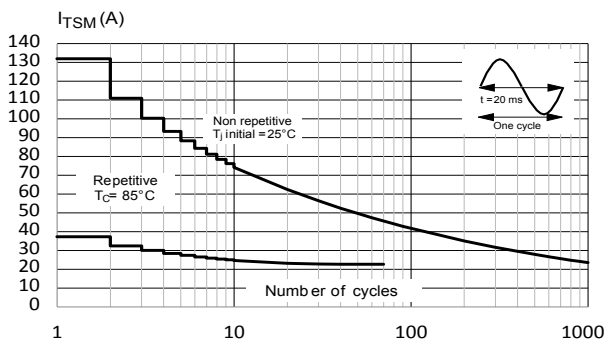

**Figure 6. Non-repetitive surge peak on-state current for a sinusoidal pulse with width  $t_p < 10 \text{ ms}$**

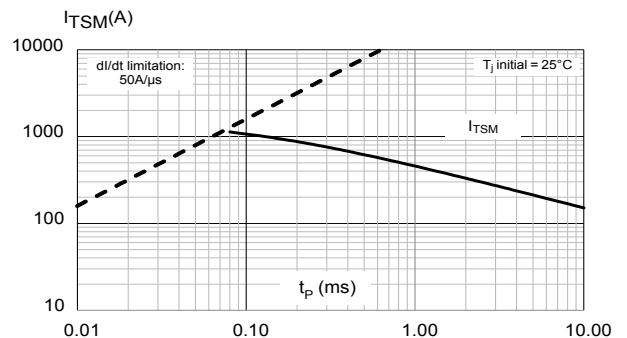

**Figure 7. Relative variation of critical rate of decrease of main current versus junction temperature**

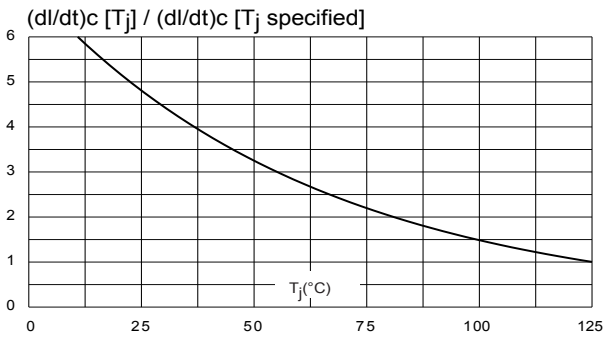

**Figure 8. Relative variation of gate trigger current and latching current versus junction temperature (typical values)**

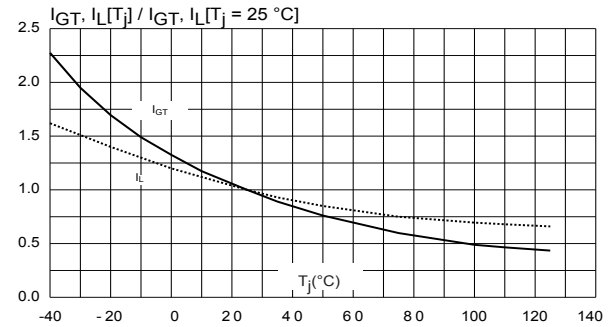

**Figure 9. Relative variation of holding current versus junction temperature (typical values)**

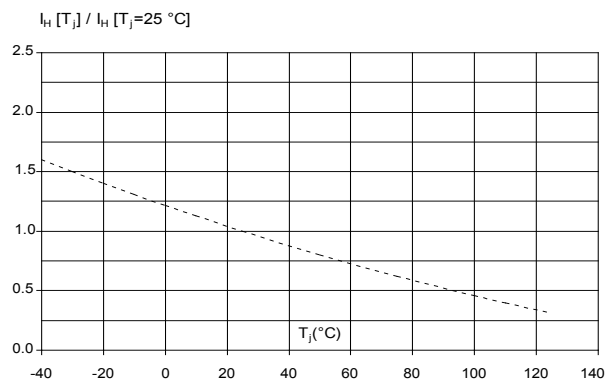

## 2 Package information

In order to meet environmental requirements, ST offers these devices in different grades of **ECOPACK** packages, depending on their level of environmental compliance. ECOPACK specifications, grade definitions and product status are available at: [www.st.com](http://www.st.com). ECOPACK is an ST trademark.

### 2.1 TO-220AB insulated package information

- Epoxy meets UL 94, V0
- Cooling method: by conduction (C)
- Recommended torque value: 0.55 N·m
- Maximum torque value: 0.70 N·m

Figure 10. TO-220AB insulated package outline

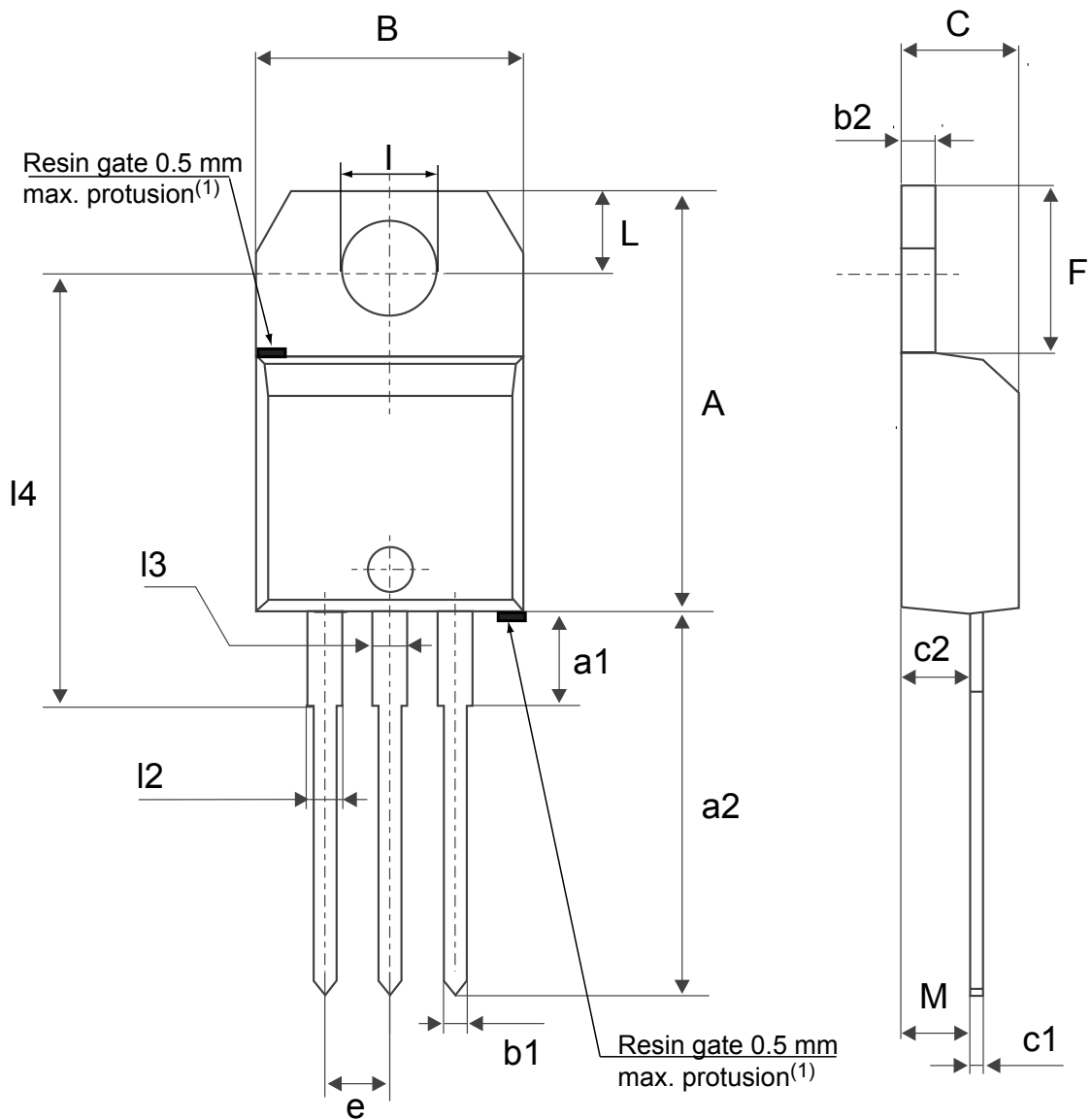

(1) Resin gate position accepted in one of the two positions or in the symmetrical opposites.

**Table 5. TO-220AB insulated package mechanical data**

Ref.	Dimensions					
	Millimeters			Inches <sup>(1)</sup>		
	Min.	Typ.	Max.	Min.	Typ.	Max.
A	15.20		15.90	0.5984		0.6260
a1		3.75			0.1476	
a2	13.00		14.00	0.5118		0.5512
B	10.00		10.40	0.3937		0.4094
b1	0.61		0.88	0.0240		0.0346
b2	1.23		1.32	0.0484		0.0520
C	4.40		4.60	0.1732		0.1811
c1	0.49		0.70	0.0193		0.0276
c2	2.40		2.72	0.0945		0.1071
e	2.40		2.70	0.0945		0.1063
F	6.20		6.60	0.2441		0.2598
I	3.73		3.88	0.1469		0.1528
L	2.65		2.95	0.1043		0.1161
I2	1.14		1.70	0.0449		0.0669
I3	1.14		1.70	0.0449		0.0669
I4	15.80	16.40	16.80	0.6220	0.6457	0.6614
M		2.6			0.1024	

1. Inch dimensions are for reference only.

### 3 Ordering information

Figure 11. Ordering information scheme

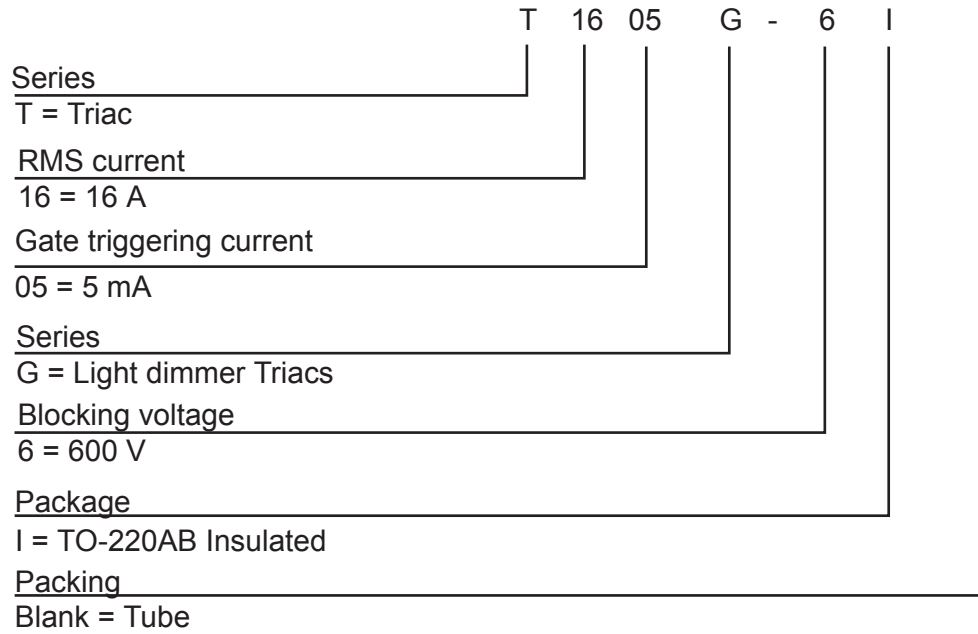

Table 6. Ordering information

Order code	Marking	Package	Weight	Base qty.	Delivery mode
T1605G-6I	T1605G-6I	TO-220AB-Ins.	2.3 g	50	Tube



## Revision history

**Table 7. Document revision history**

Date	Revision	Changes
07-Oct-2020	1	Initial release.
28-Oct-2020	2	Updated <a href="#">Table 6</a> .
27-Sep-2021	3	Updated cover image pin name, <a href="#">Figure 7</a> and <a href="#">Figure 9</a> .

**IMPORTANT NOTICE – PLEASE READ CAREFULLY**

STMicroelectronics NV and its subsidiaries (“ST”) reserve the right to make changes, corrections, enhancements, modifications, and improvements to ST products and/or to this document at any time without notice. Purchasers should obtain the latest relevant information on ST products before placing orders. ST products are sold pursuant to ST’s terms and conditions of sale in place at the time of order acknowledgement.

Purchasers are solely responsible for the choice, selection, and use of ST products and ST assumes no liability for application assistance or the design of Purchasers’ products.

No license, express or implied, to any intellectual property right is granted by ST herein.

Resale of ST products with provisions different from the information set forth herein shall void any warranty granted by ST for such product.

ST and the ST logo are trademarks of ST. For additional information about ST trademarks, please refer to [www.st.com/trademarks](http://www.st.com/trademarks). All other product or service names are the property of their respective owners.

Information in this document supersedes and replaces information previously supplied in any prior versions of this document.

© 2021 STMicroelectronics – All rights reserved