

Overvoltage protected AC switch (ACS™)

Datasheet – production data

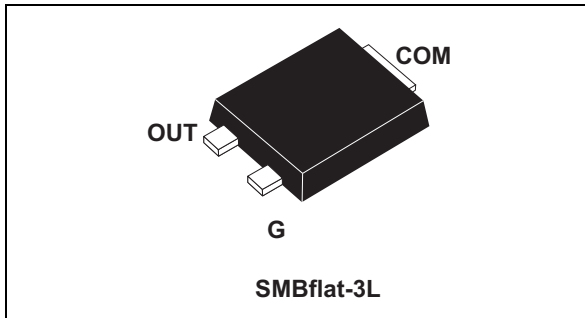

Description

The ACS108-8SUN belongs to the AC line switch range (built with A.S.D.® technology). This high performance switch can control a load of up to 0.8 A.

The ACS108-8SUN switch includes an overvoltage crowbar structure to absorb the overvoltage energy and a gate level shifter driver to separate the digital controller from the main switch. It is triggered with a negative gate current flowing out of the gate pin.

Features

- Less footprint area than SOT-223 (saves PCB)
- ECOPACK®2 compliant component
- Thinner option versus SOT-223 (1.1 mm max. thickness)
- Enables equipment to meet IEC 61000-4-5
- High noise immunity against static dV/dt and IEC 61000-4-4 burst
- Overvoltage protection by crowbar technology
- Needs no external protection snubber or varistor
- Reduces component count by up to 80% and Interfaces directly with the micro-controller
- V_{CL} gives headroom before clamping then crowbar action
- Common package tab connection supports connection of several alternating current switches on the same cooling pad

Applications

- Alternating current on/off static switching in appliances and industrial control systems
- Drive of low power high inductive or resistive loads like:
 - relay, valve, solenoid, dispenser,
 - pump, fan, low power motor, door lock,
 - lamp

Figure 1. Functional diagram

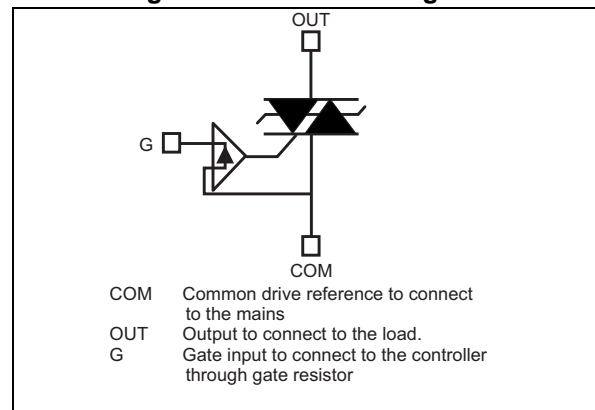

Table 1. Device summary

Symbol	Value	Unit
$I_{T(RMS)}$	0.8	A
V_{DRM} / V_{RRM}	800	V
I_{GT}	10	mA

®: ECOPACK2 is a registered trademark of STMicroelectronics

TM: ACS is a trademark of STMicroelectronics

®: A.S.D. is a registered trademark of STMicroelectronics

1 Characteristics

Table 2. Absolute maximum ratings ($T_{amb} = 25\text{ °C}$, unless otherwise specified)

Symbol	Parameter		Value	Unit	
$I_{T(RMS)}$	On-state rms current (full sine wave)	$S = 0.5\text{ cm}^2$ $T_{amb} = 75\text{ °C}$	0.45	A	
		$T_{tab} = 113\text{ °C}$	0.8	A	
I_{TSM}	Non repetitive surge peak on-state current (full cycle sine wave, T_j initial = 25 °C)	$F = 60\text{ Hz}$ $t = 16.7\text{ ms}$	13.7	A	
		$F = 50\text{ Hz}$ $t = 20\text{ ms}$	13		
I^2t	I^2t Value for fusing		$t_p = 10\text{ ms}$	1.1	A^2s
di/dt	Critical rate of rise of on-state current $I_G = 2 \times I_{GT}$, $tr \leq 100\text{ ns}$	$F = 120\text{ Hz}$ $T_j = 125\text{ °C}$	100	$A/\mu s$	
V_{PP}	Non repetitive line peak pulse mains voltage ⁽¹⁾		$T_j = 25\text{ °C}$	2	kV
I_{GM}	Peak gate current	$t_p = 20\text{ }\mu s$ $T_j = 125\text{ °C}$	1	A	
V_{GM}	Peak positive gate voltage		$T_j = 125\text{ °C}$	10	V
$P_{G(AV)}$	Average gate power dissipation		$T_j = 125\text{ °C}$	0.1	W
T_{stg} T_j	Storage junction temperature range		-40 to +150	$^{\circ}C$	
	Operating junction temperature range		-30 to +125		

1. according to test described by IEC 61000-4-5 standard and [Figure 19](#)

Table 3. Electrical characteristics ($T_j = 25\text{ °C}$, unless otherwise specified)

Symbol	Test conditions	Quadrant		Value	Unit
$I_{GT}^{(1)}$	$V_{OUT} = 12\text{ V}$, $R_L = 33\text{ }\Omega$	II - III	Max.	10	mA
V_{GT}				1	V
V_{GD}	$V_{OUT} = V_{DRM}$, $R_L = 3.3\text{ k}\Omega$, $T_j = 125\text{ °C}$	II - III	Min.	0.15	V
I_H	$I_{OUT} = 100\text{ mA}$		Max.	10	mA
I_L	$I_G = 1.2 \times I_{GT}$		Max.	25	mA
dV/dt	$V_{OUT} = 402\text{ V}$, gate open, $T_j = 125\text{ °C}$		Min.	2000	$V/\mu s$
	$V_{OUT} = 536\text{ V}$, gate open, $T_j = 125\text{ °C}$		Min.	400	$V/\mu s$
$(di/dt)_c$	Without snubber ($15\text{ V}/\mu s$), turn-off time $\leq 20\text{ ms}$, $T_j = 125\text{ °C}$		Min.	2	A/ms
V_{CL}	$I_{CL} = 0.1\text{ mA}$, $t_p = 1\text{ ms}$, $T_j = 125\text{ °C}$		Min.	850	V

1. Minimum I_{GT} is guaranteed at 10% of I_{GT} max

Table 4. Static electrical characteristics

Symbol	Test conditions		Value	Unit
$V_{TM}^{(1)}$	$I_{TM} = 1.1 \text{ A}$, $t_p = 500 \mu\text{s}$	$T_j = 25 \text{ }^\circ\text{C}$	Max. 1.3	V
$V_{TO}^{(1)}$	Threshold voltage	$T_j = 125 \text{ }^\circ\text{C}$	Max. 0.85	V
$R_D^{(1)}$	Dynamic resistance	$T_j = 125 \text{ }^\circ\text{C}$	Max. 300	m Ω
I_{DRM} I_{RRM}	$V_{OUT} = V_{DRM} = V_{RRM}$	$T_j = 25 \text{ }^\circ\text{C}$	Max. 2	μA
		$T_j = 125 \text{ }^\circ\text{C}$		mA

1. For both polarities of OUT referenced to COM

Table 5. Thermal resistance

Symbol	Parameter		Value	Unit
$R_{th(j-t)}$	Junction to tab (AC)		Max. 14	$^\circ\text{C/W}$
$R_{th(j-a)}$	Junction to ambient	$S = 0.5 \text{ cm}^2$	Max. 130	

Figure 2. Maximum power dissipation versus on-state rms current (full cycle)

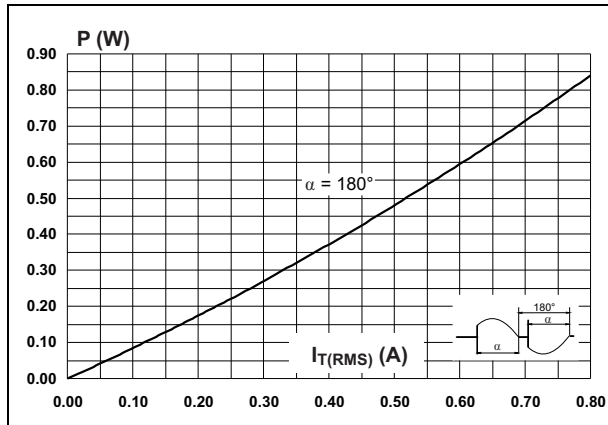

Figure 3. On-state rms current versus tab temperature (full cycle)

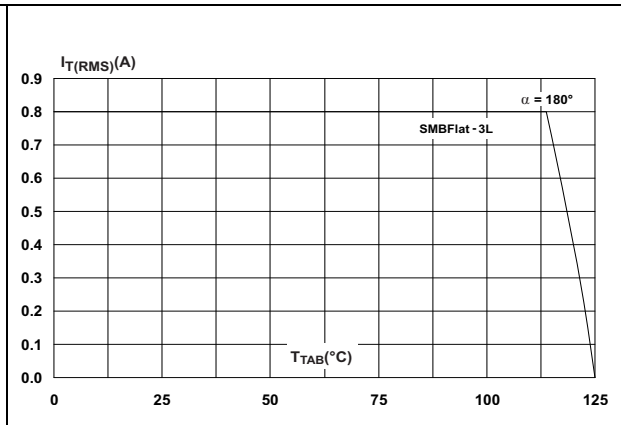

Figure 4. On-state rms current versus ambient temperature (free air convection)

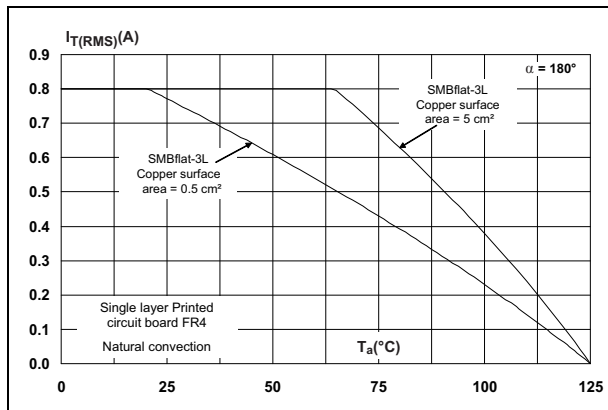

Figure 5. Relative variation of thermal impedance junction to ambient versus pulse duration

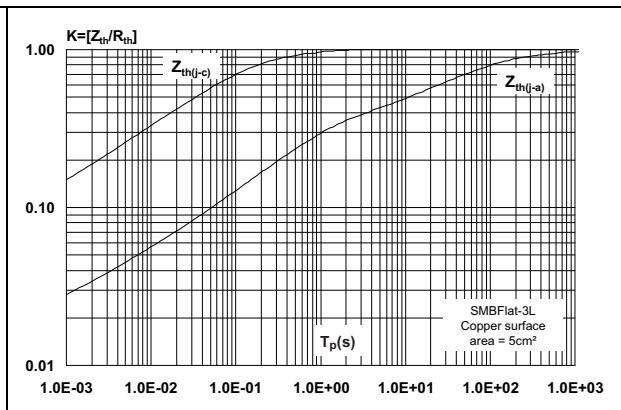

Figure 6. Relative variation of holding and latching current versus junction temperature

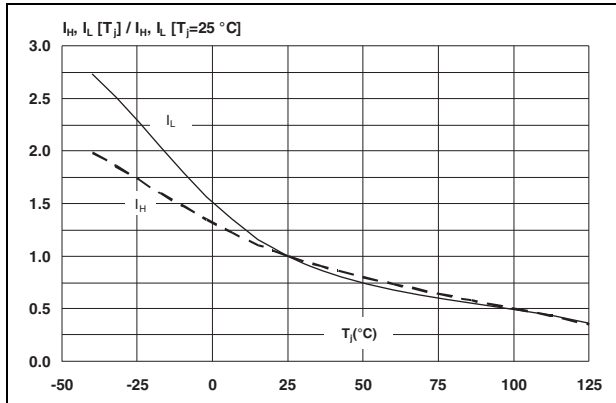

Figure 7. Relative variation of I_{GT} and V_{GT} versus junction temperature

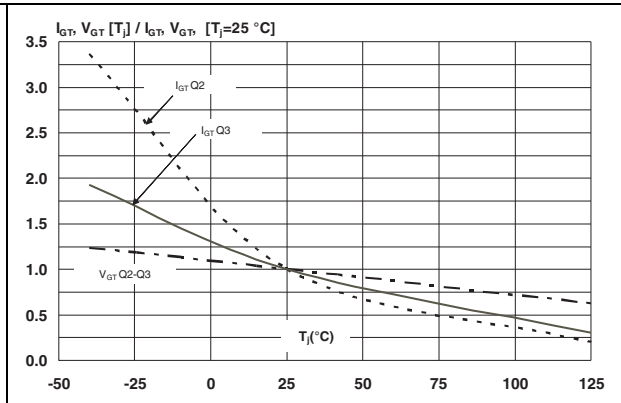

Figure 8. Surge peak on-state current versus number of cycles

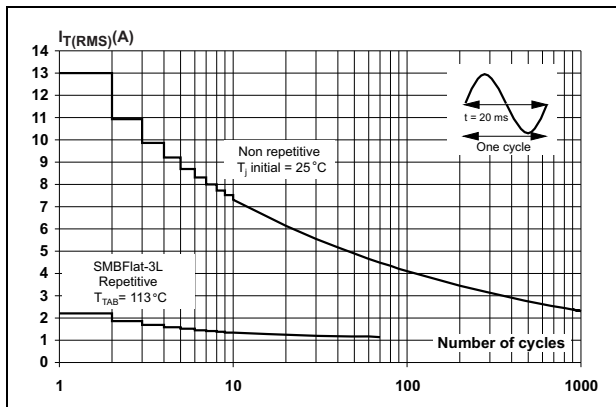

Figure 9. Non repetitive surge peak on-state current for a sinusoidal pulse, and corresponding value of I^2t

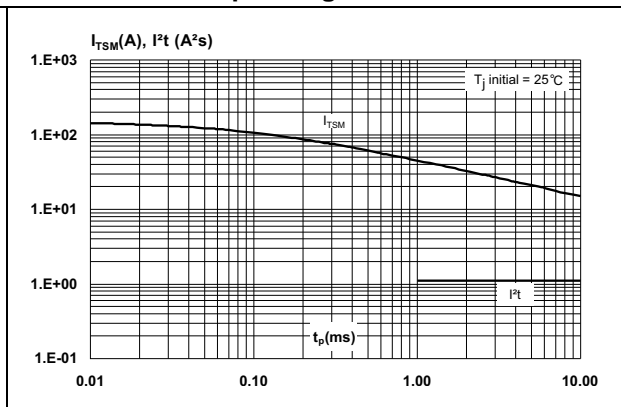

Figure 10. On-state characteristics (maximum values)

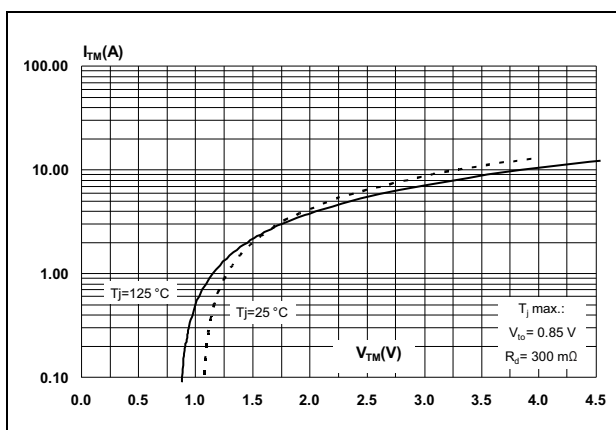

Figure 11. Relative variation of critical rate of decrease of main current versus junction temperature

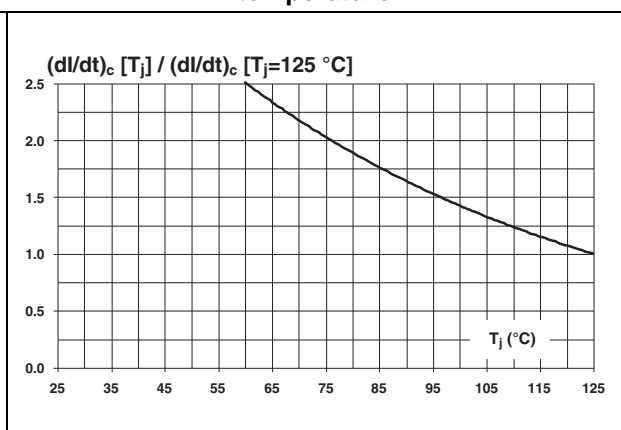

Figure 12. Relative variation of static dV/dt immunity versus junction temperature

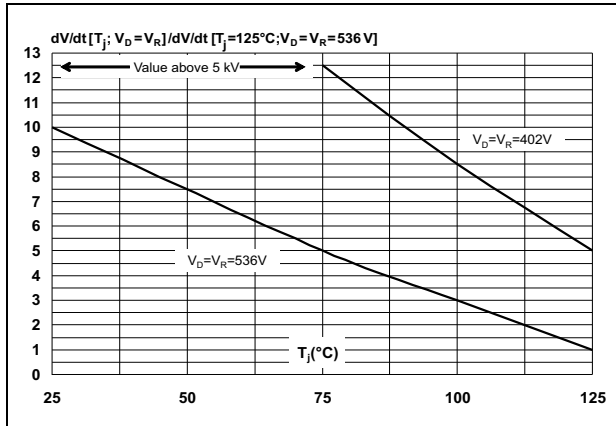

Figure 13. Relative variation of leakage current versus junction temperature

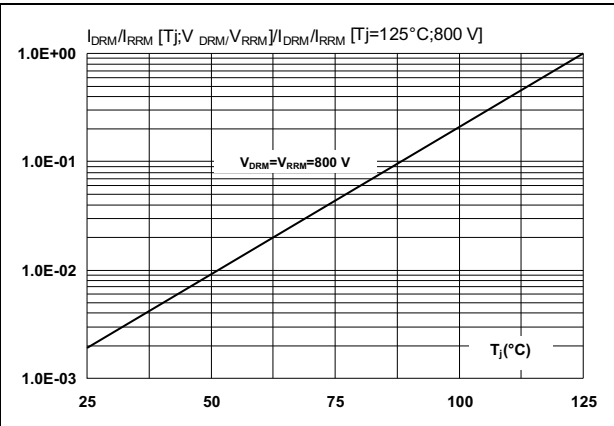

Figure 14. Relative variation of critical rate of decrease of main current (dl/dt)_c versus (dV/dt)_c

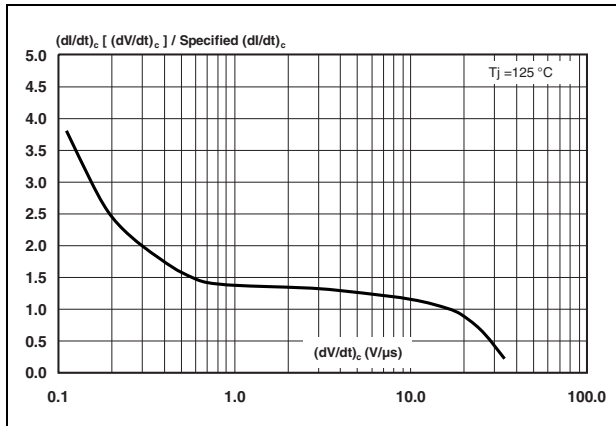
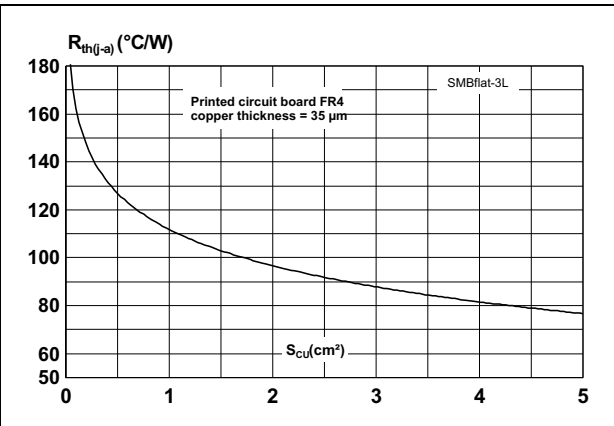

Figure 15. Thermal resistance junction to ambient versus copper surface under tab



2 Alternating current line switch - basic application

The ACS108-8SUN switch is triggered by a negative gate current flowing from the gate pin G. The switch can be driven directly by the digital controller through a resistor as shown in [Figure 16](#).

Thanks to its overvoltage protection and turn-off commutation performance, the ACS108-8SUN switch can drive a small power high inductive load with neither varistor nor additional turn-off snubber.

Figure 16. Typical application program

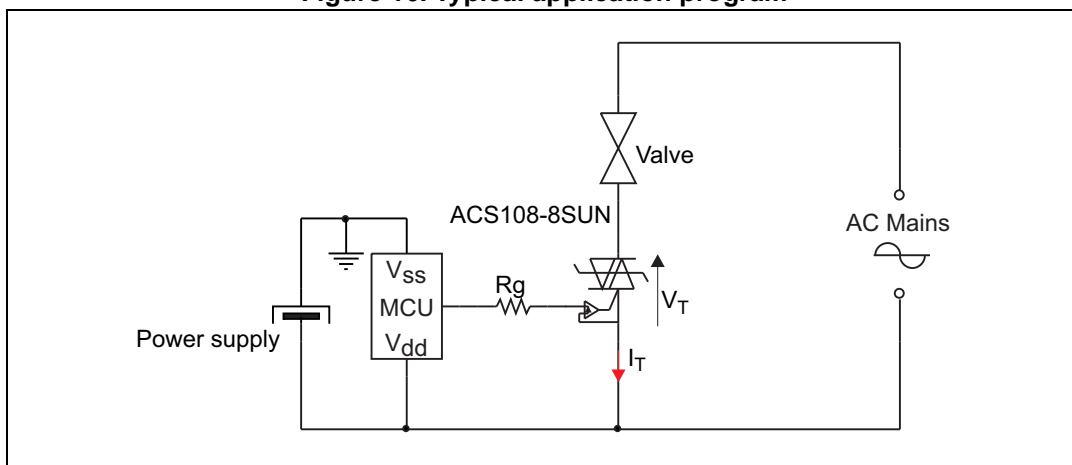

2.1 Protection against overvoltage: the best choice is ACS

In comparison with standard Triacs, which are not robust against surge voltage, the ACS108-8SUN is over-voltage self-protected, specified by the new parameter V_{CL} . This feature is useful in two operating conditions: in case of turn-off of very inductive load, and in case of surge voltage that can occur on the electrical network.

2.1.1 High inductive load switch-off: turn-off overvoltage clamping

With high inductive and low RMS current loads the rate of decrease of the current is very low. An overvoltage can occur when the gate current is removed and the OUT current is lower than I_H .

As shown in [Figure 17](#) and [Figure 18](#), at the end of the last conduction half-cycle, the load current decreases (1). The load current reaches the holding current level I_H (2), and the ACS108-8SUN turns off (3). The water valve, as an inductive load (up to 15 H), reacts as a current generator and an overvoltage is created, which is clamped by the ACS108-8SUN (4). The current flows through the ACS108-8SUN avalanche and decreases linearly to zero. During this time, the voltage across the switch is limited to the clamping voltage V_{CL} . The energy stored in the inductance of the load is dissipated in the clamping section that is designed for this purpose. When the energy has been dissipated, the ACS108-8SUN voltage falls back to the mains voltage value (5) ($230 V_{rms}$, 50 Hz).

Figure 17. Effect of the switching off of a high inductive load - typical clamping capability of ACS108-8SUN ($T_{amb} = 25\text{ }^{\circ}\text{C}$)

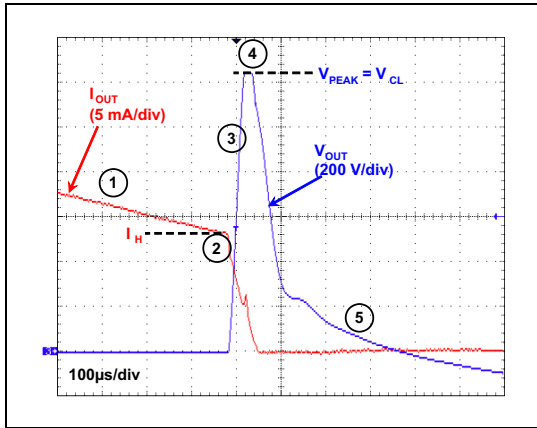
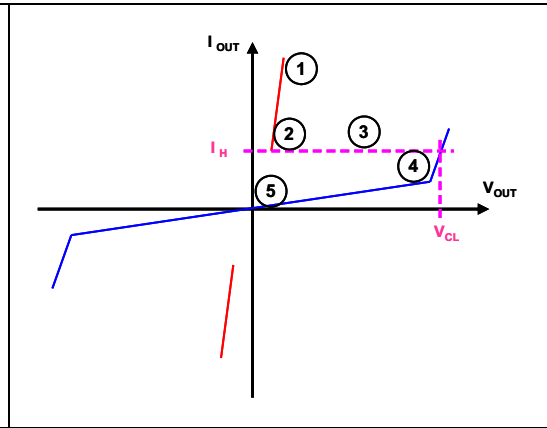

Figure 18. Description of the different steps during switching off of a high inductive load



2.1.2 Alternating current line transient voltage ruggedness

The ACS108-8SUN switch is able to withstand safely the ac line transients either by clamping the low energy spikes or by breaking over under high energy shocks, even with high turn-on current rises.

The test circuit shown in *Figure 19* is representative of the final ACS108-8SUN application, and is also used to test the ac switch according to the IEC 61000-4-5 standard conditions. Thanks to the load limiting the current, the ACS108-8SUN switch withstands the voltage spikes up to 2 kV above the peak line voltage. The protection is based on an overvoltage crowbar technology. Actually, the ACS108-8SUN breaks over safely as shown in *Figure 20*. The ACS108-8SUN recovers its blocking voltage capability after the surge (switch off back at the next zero crossing of the current).

Such non-repetitive tests can be done 10 times on each ac line voltage polarity.

Figure 19. Overvoltage ruggedness test circuit for resistive and inductive loads with conditions equivalent to IEC 61000-4-5 standards

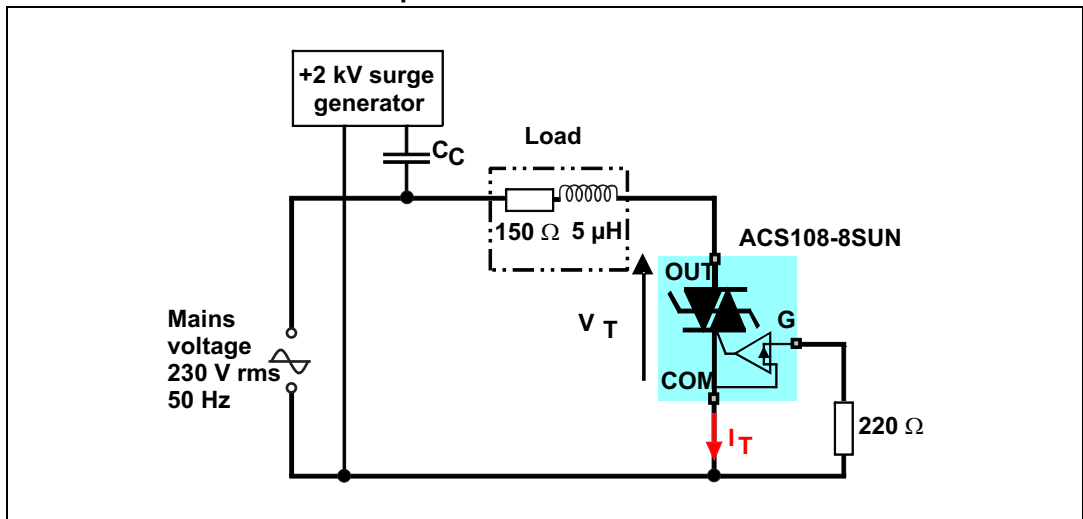
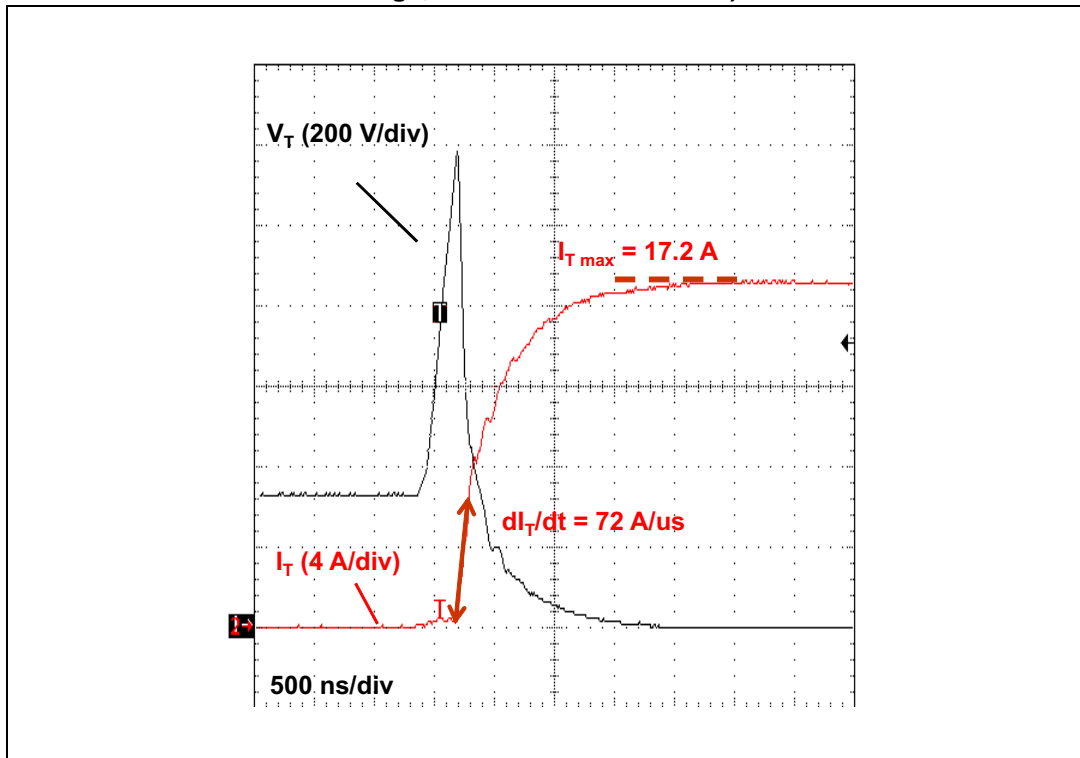

Figure 20. Typical current and voltage waveforms across the ACS108-8SUN (+2 kV surge, IEC 61000-4-5 standard)



3 Package information

- Epoxy meets UL94, V0
- Lead-free packages

In order to meet environmental requirements, ST offers these devices in different grades of ECOPACK® packages, depending on their level of environmental compliance. ECOPACK® specifications, grade definitions and product status are available at: www.st.com. ECOPACK® is an ST trademark.

Figure 21. SMBflat-3L dimension definitions

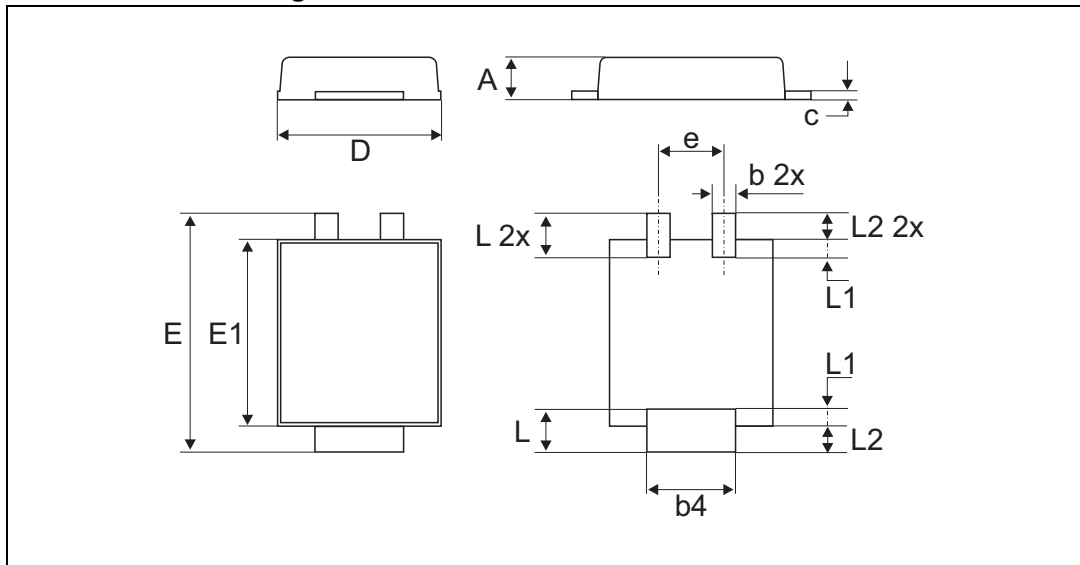
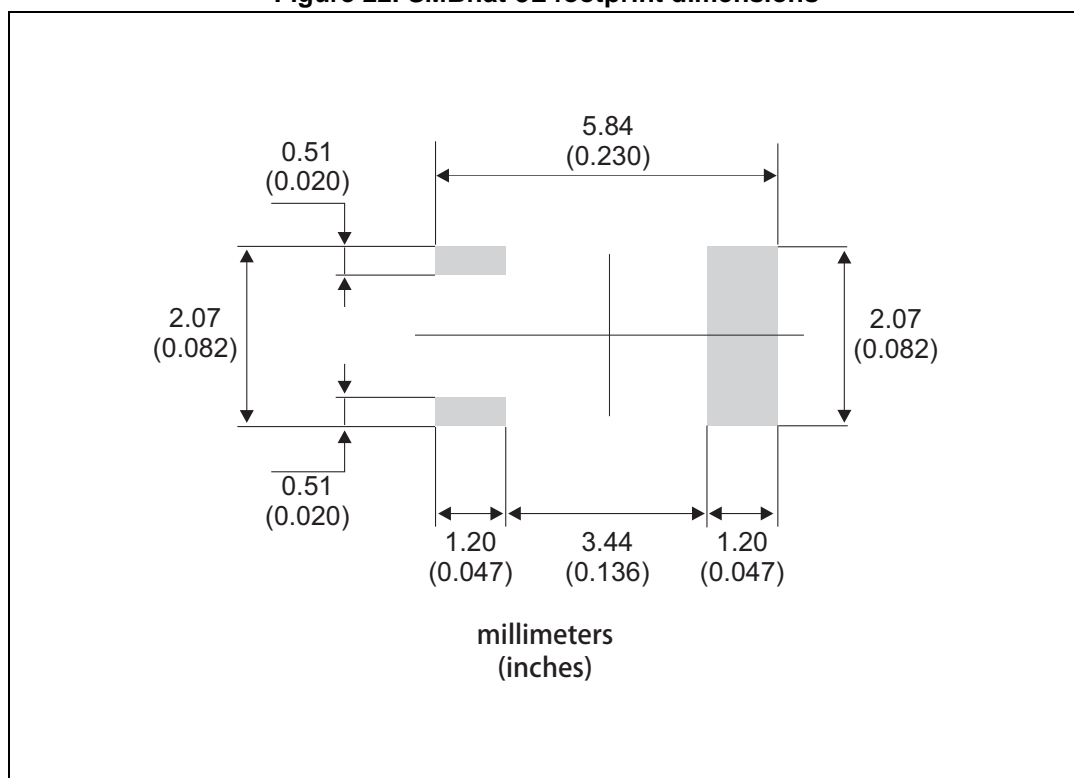

Table 6. SMBflat-3L dimensions

Ref.	Dimensions					
	Millimeters			Inches		
	Min.	Typ.	Max.	Min.	Typ.	Max.
A	0.90		1.10	0.035		0.043
b	0.35		0.65	0.014		0.026
b4	1.95		2.20	0.07		0.087
c	0.15		0.40	0.006		0.016
D	3.30		3.95	0.130		0.156
E	5.10		5.60	0.201		0.220
E1	4.05		4.60	0.156		0.181
L	0.75		1.50	0.030		0.059
L1		0.40			0.016	
L2		0.60			0.024	
e		1.60			0.063	

Figure 22. SMBflat-3L footprint dimensions



4 Ordering information

Figure 23. Ordering information scheme

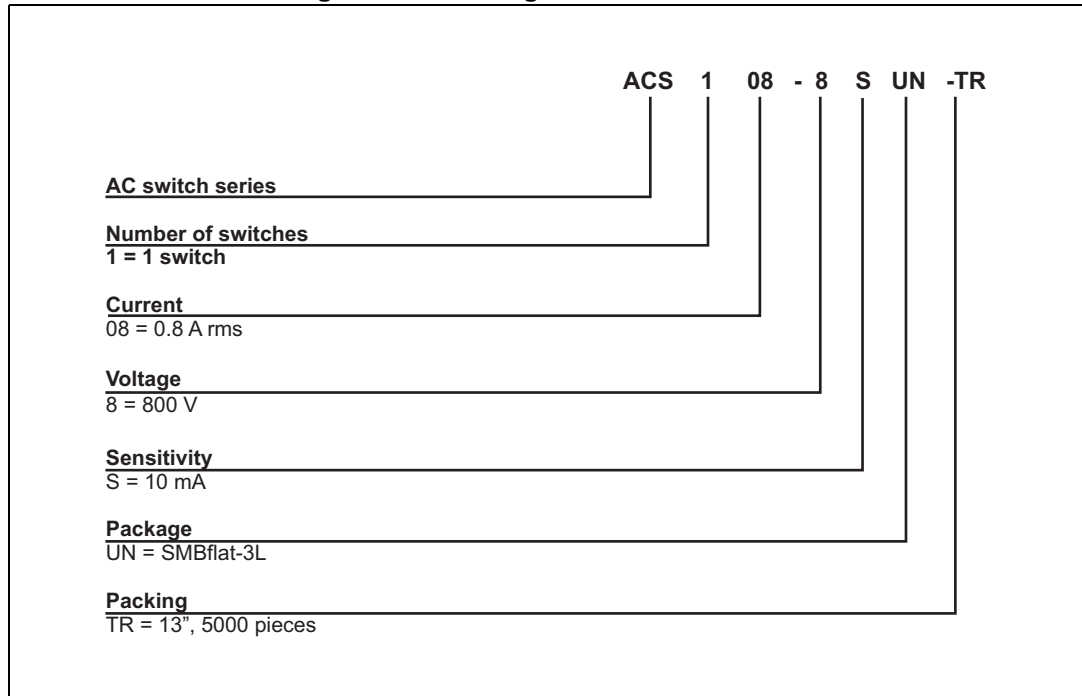

Table 7. Ordering information

Order code	Marking	Package	Weight	Base Qty	Delivery mode
ACS108-8SUN-TR	A088N	SMBflat-3L	0.2 g	2000	Tape and reel

5 Revision history

Table 8. Document revision history

Date	Revision	Changes
30-Jul-2014	1	Initial release.

IMPORTANT NOTICE – PLEASE READ CAREFULLY

STMicroelectronics NV and its subsidiaries (“ST”) reserve the right to make changes, corrections, enhancements, modifications, and improvements to ST products and/or to this document at any time without notice. Purchasers should obtain the latest relevant information on ST products before placing orders. ST products are sold pursuant to ST’s terms and conditions of sale in place at the time of order acknowledgement.

Purchasers are solely responsible for the choice, selection, and use of ST products and ST assumes no liability for application assistance or the design of Purchasers’ products.

No license, express or implied, to any intellectual property right is granted by ST herein.

Resale of ST products with provisions different from the information set forth herein shall void any warranty granted by ST for such product.

ST and the ST logo are trademarks of ST. All other product or service names are the property of their respective owners.

Information in this document supersedes and replaces information previously supplied in any prior versions of this document.

© 2014 STMicroelectronics – All rights reserved