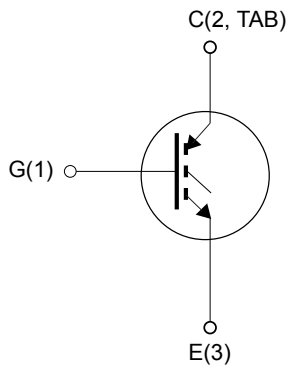
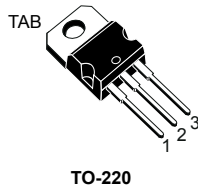


## Trench gate field-stop, 650 V, 20 A, high-speed HB2 series IGBT in a TO-220 package



G1C2TE3



### Features

- Maximum junction temperature :  $T_J = 175\text{ °C}$
- Low  $V_{CE(sat)} = 1.65\text{ V (typ.) @ } I_C = 20\text{ A}$
- Minimized tail current
- Tight parameter distribution
- Low thermal resistance
- Positive  $V_{CE(sat)}$  temperature coefficient

### Applications

- Welding
- Power factor correction
- UPS
- Solar inverters
- Chargers

### Description

The newest IGBT 650 V HB2 series represents an evolution of the advanced proprietary trench gate field-stop structure. The performance of the HB2 series is optimized in terms of conduction, thanks to a better  $V_{CE(sat)}$  behavior at low current values, as well as in terms of reduced switching energy. The result is a product specifically designed to maximize efficiency for a wide range of fast applications.

#### Product status link

[STGP20H65FB2](#)

#### Product summary

Order code	STGP20H65FB2
Marking	G20H65FB2
Package	TO-220
Packing	Tube

# 1 Electrical ratings

**Table 1. Absolute maximum ratings**

Symbol	Parameter	Value	Unit
$V_{CES}$	Collector-emitter voltage ( $V_{GE} = 0$ V)	650	V
$I_C$	Continuous collector current at $T_C = 25$ °C	40	A
	Continuous collector current at $T_C = 100$ °C	25	
$I_{CP}^{(1)(2)}$	Pulsed collector current	60	
$V_{GE}$	Gate-emitter voltage	$\pm 20$	V
	Transient gate-emitter voltage ( $t_p \leq 10$ $\mu$ s)	$\pm 30$	
$P_{TOT}$	Total power dissipation at $T_C = 25$ °C	147	W
$T_{stg}$	Storage temperature range	-55 to 150	°C
$T_J$	Operating junction temperature range	-55 to 175	

1. Defined by design, not subject to production test.
2. Pulse width is limited by maximum junction temperature.

**Table 2. Thermal data**

Symbol	Parameter	Value	Unit
$R_{thJC}$	Thermal resistance junction-case	1.02	°C/W
$R_{thJA}$	Thermal resistance junction-ambient	62.5	

## 2 Electrical characteristics

$T_C = 25\text{ °C}$  unless otherwise specified

**Table 3. Static characteristics**

Symbol	Parameter	Test conditions	Min.	Typ.	Max.	Unit
$V_{(BR)CES}$	Collector-emitter breakdown voltage	$V_{GE} = 0\text{ V}, I_C = 1\text{ mA}$	650			V
$V_{CE(sat)}$	Collector-emitter saturation voltage	$V_{GE} = 15\text{ V}, I_C = 20\text{ A}$		1.65	2.1	V
		$V_{GE} = 15\text{ V}, I_C = 20\text{ A}, T_J = 125\text{ °C}$		1.95		
		$V_{GE} = 15\text{ V}, I_C = 20\text{ A}, T_J = 175\text{ °C}$		2.1		
$V_{GE(th)}$	Gate threshold voltage	$V_{CE} = V_{GE}, I_C = 1\text{ mA}$	5	6	7	V
$I_{CES}$	Collector cut-off current	$V_{GE} = 0\text{ V}, V_{CE} = 650\text{ V}$			25	$\mu\text{A}$
$I_{GES}$	Gate-emitter leakage current	$V_{CE} = 0\text{ V}, V_{GE} = \pm 20\text{ V}$			$\pm 250$	nA

**Table 4. Dynamic characteristics**

Symbol	Parameter	Test conditions	Min.	Typ.	Max.	Unit
$C_{ies}$	Input capacitance	$V_{CE} = 25\text{ V}, f = 1\text{ MHz}, V_{GE} = 0\text{ V}$	-	1010	-	$\mu\text{F}$
$C_{oes}$	Output capacitance		-	81	-	
$C_{res}$	Reverse transfer capacitance		-	26	-	
$Q_g$	Total gate charge	$V_{CC} = 520\text{ V}, I_C = 20\text{ A}, V_{GE} = 0\text{ to }15\text{ V}$ (see Figure 22. Gate charge test circuit)	-	56	-	nC
$Q_{ge}$	Gate-emitter charge		-	9.4	-	
$Q_{gc}$	Gate-collector charge		-	27.8	-	

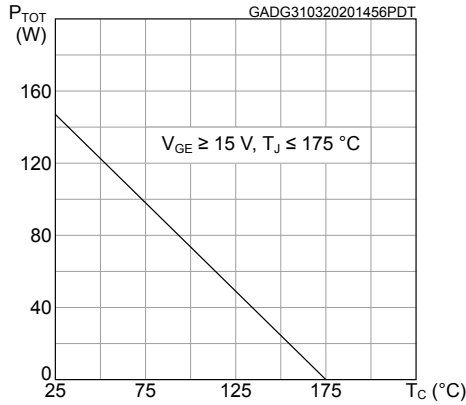
**Table 5. Switching characteristics (inductive load)**

Symbol	Parameter	Test conditions	Min.	Typ.	Max.	Unit
$t_{d(on)}$	Turn-on delay time	$V_{CC} = 400\text{ V}$ , $I_C = 20\text{ A}$ , $V_{GE} = 15\text{ V}$ , $R_G = 10\ \Omega$ (see Figure 21. Test circuit for inductive load switching)	-	16	-	ns
$t_r$	Current rise time		-	8	-	ns
$E_{on(1)}$	Turn-on switching energy		-	265	-	$\mu\text{J}$
$t_{d(off)}$	Turn-off delay time		-	78.8	-	ns
$t_f$	Current fall time		-	35	-	ns
$E_{off(2)}$	Turn-off switching energy		-	214	-	$\mu\text{J}$
$t_{d(on)}$	Turn-on delay time	$V_{CC} = 400\text{ V}$ , $I_C = 20\text{ A}$ , $V_{GE} = 15\text{ V}$ , $R_G = 10\ \Omega$ , $T_J = 175\text{ }^\circ\text{C}$ (see Figure 21. Test circuit for inductive load switching)	-	17	-	ns
$t_r$	Current rise time		-	9	-	ns
$E_{on(1)}$	Turn-on switching energy		-	556	-	$\mu\text{J}$
$t_{d(off)}$	Turn-off delay time		-	98	-	ns
$t_f$	Current fall time		-	80	-	ns
$E_{off(2)}$	Turn-off switching energy		-	378	-	$\mu\text{J}$

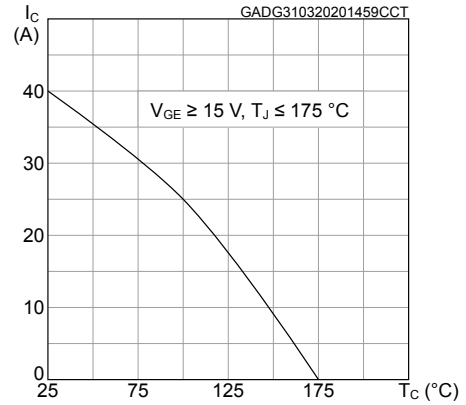
1. Including the reverse recovery of the external diode. The diode is the same of the co-packed STGWA20H65DFB2.
2. Including the tail of the collector current.

## 2.1 Electrical characteristics (curves)

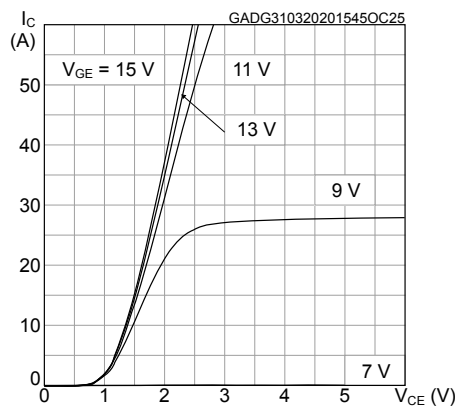
**Figure 1. Power dissipation vs case temperature**



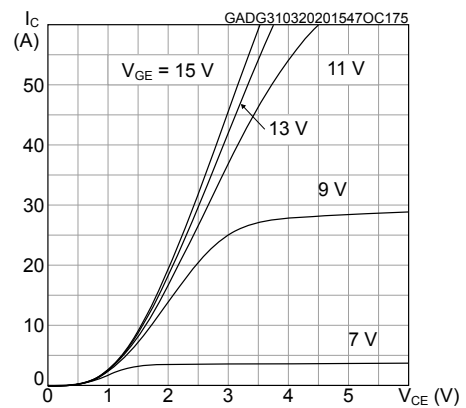
**Figure 2. Collector current vs case temperature**



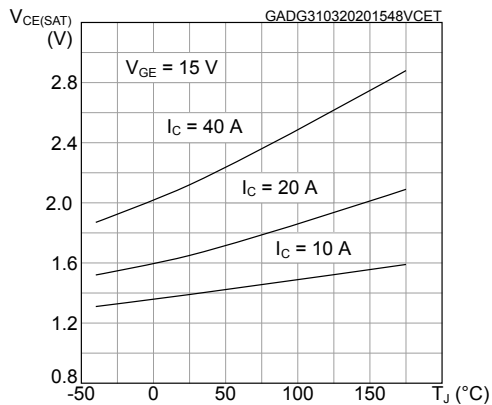
**Figure 3. Output characteristics (T<sub>J</sub> = 25 °C)**



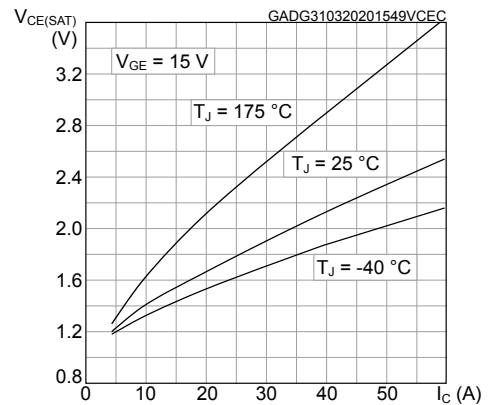
**Figure 4. Output characteristics (T<sub>J</sub> = 175 °C)**



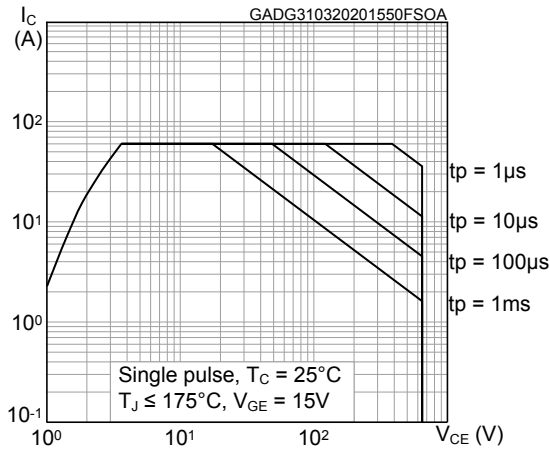
**Figure 5. V<sub>CE(sat)</sub> vs junction temperature**



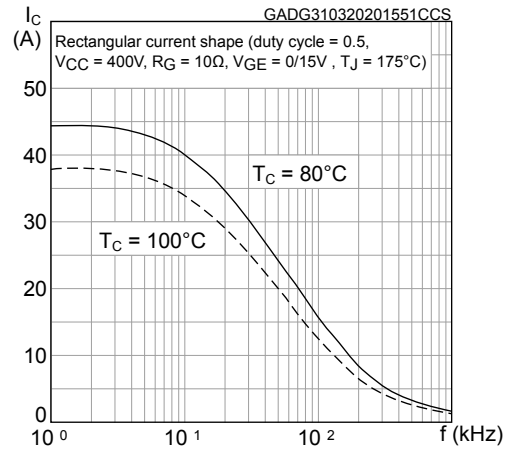
**Figure 6. V<sub>CE(sat)</sub> vs collector current**



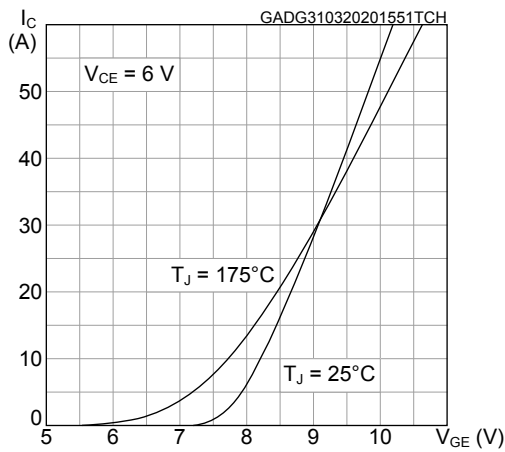
**Figure 7. Forward bias safe operating area**



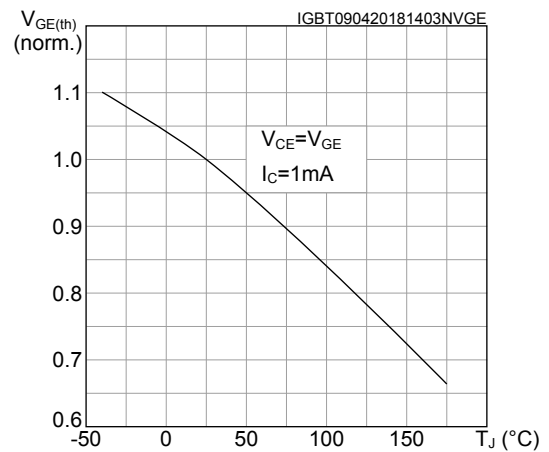
**Figure 8. Collector current vs switching frequency**



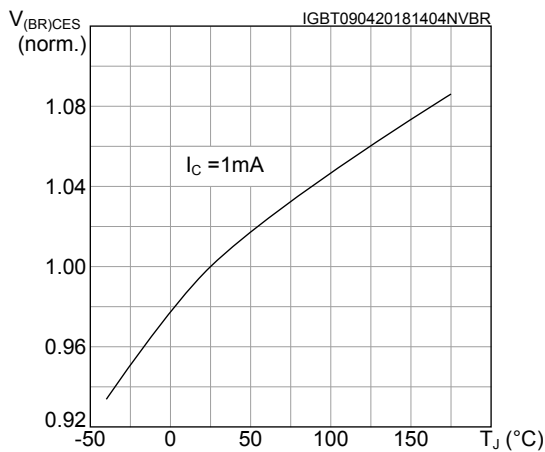
**Figure 9. Transfer characteristics**



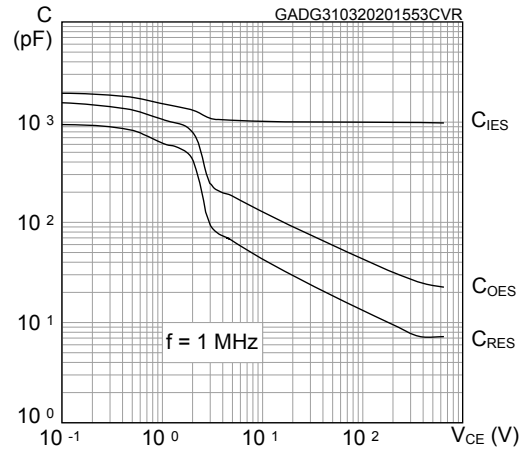
**Figure 10. Normalized V\_GE(th) vs junction temperature**



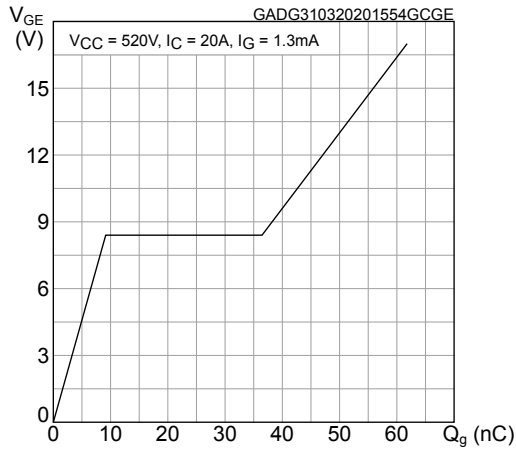
**Figure 11. Normalized V\_(BR)CES vs junction temperature**



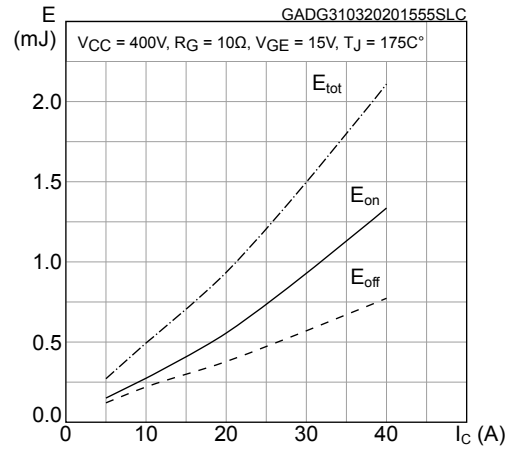
**Figure 12. Capacitance variations**



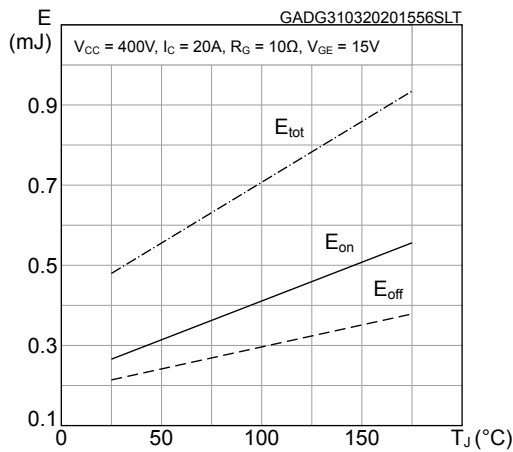
**Figure 13. Gate charge vs gate-emitter voltage**



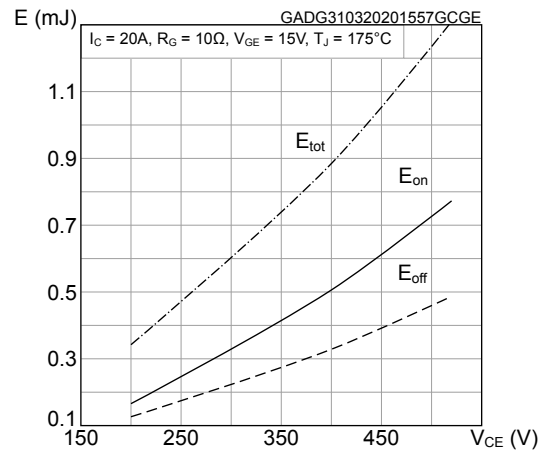
**Figure 14. Switching energy vs collector current**



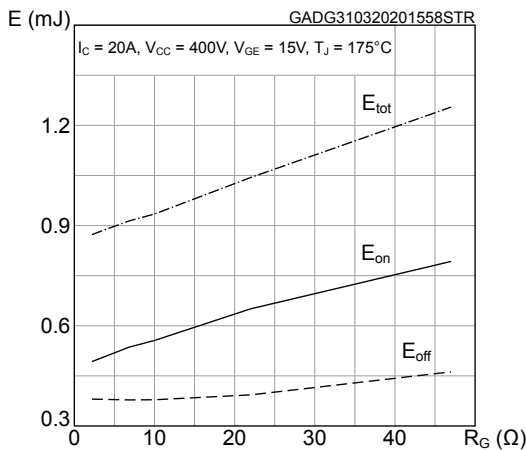
**Figure 15. Switching energy vs temperature**



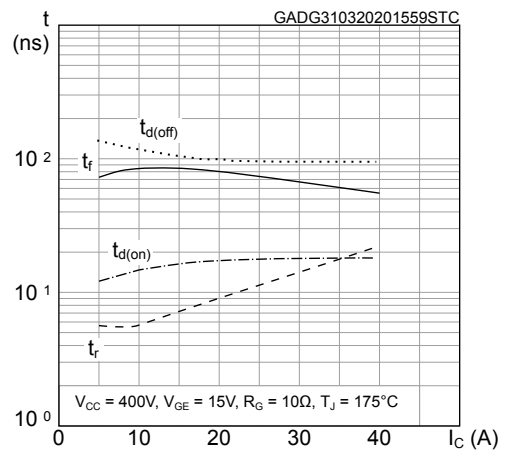
**Figure 16. Switching energy vs collector emitter voltage**



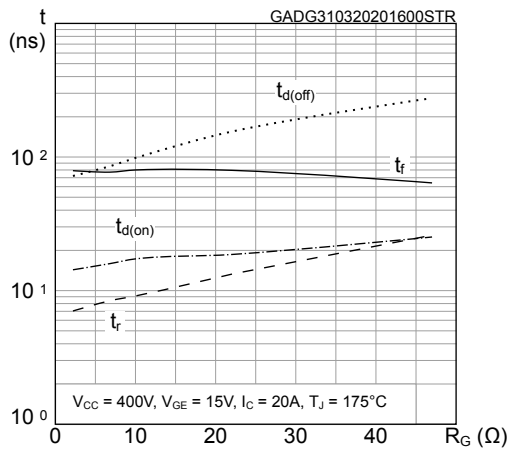
**Figure 17. Switching energy vs gate resistance**



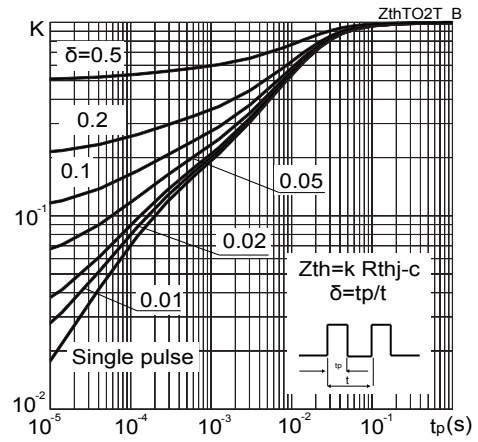
**Figure 18. Switching times vs collector current**



**Figure 19. Switching times vs gate resistance**

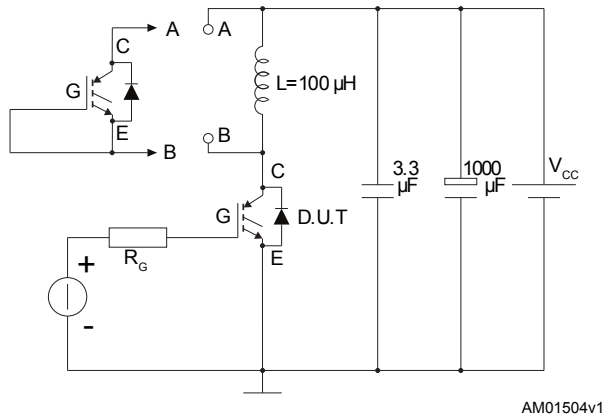
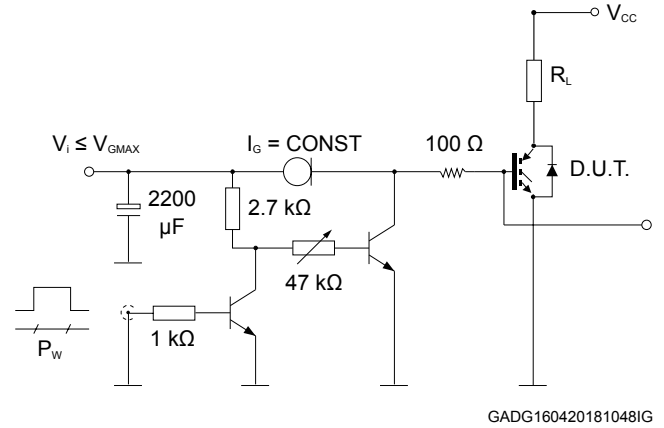
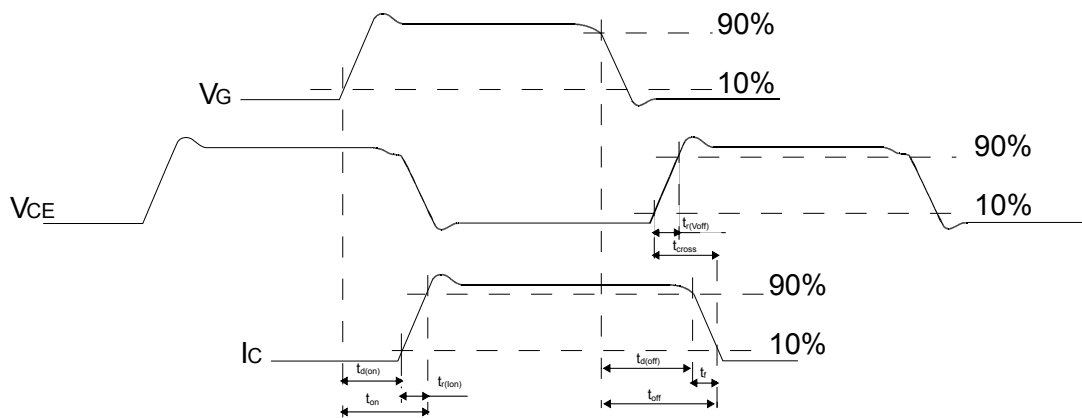


**Figure 20. Thermal impedance**





### 3 Test circuits

**Figure 21. Test circuit for inductive load switching**

**Figure 22. Gate charge test circuit**

**Figure 23. Switching waveform**


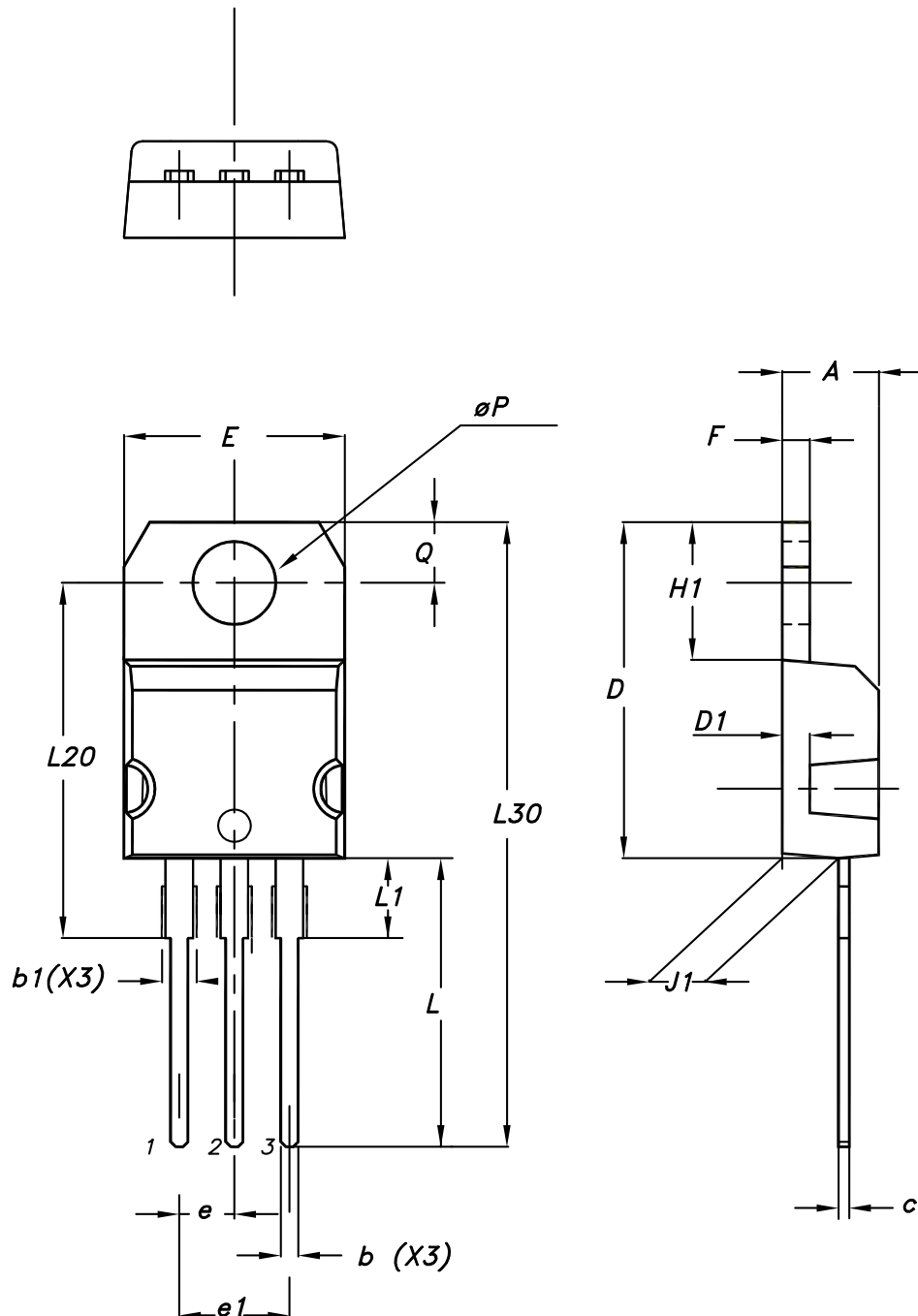
AM01506v1

## 4 Package information

In order to meet environmental requirements, ST offers these devices in different grades of **ECOPACK** packages, depending on their level of environmental compliance. ECOPACK specifications, grade definitions and product status are available at: [www.st.com](http://www.st.com). ECOPACK is an ST trademark.

### 4.1 TO-220 type A package information

Figure 24. TO-220 type A package outline



0015988\_typeA\_Rev\_23

**Table 6. TO-220 type A package mechanical data**

Dim.	mm		
	Min.	Typ.	Max.
A	4.40		4.60
b	0.61		0.88
b1	1.14		1.55
c	0.48		0.70
D	15.25		15.75
D1		1.27	
E	10.00		10.40
e	2.40		2.70
e1	4.95		5.15
F	1.23		1.32
H1	6.20		6.60
J1	2.40		2.72
L	13.00		14.00
L1	3.50		3.93
L20		16.40	
L30		28.90	
øP	3.75		3.85
Q	2.65		2.95
Slug flatness		0.03	0.10

## Revision history

**Table 7. Document revision history**

Date	Version	Changes
20-May-2020	1	First release.

---

## Contents

<b>1</b>	<b>Electrical ratings</b> .....	<b>2</b>
<b>2</b>	<b>Electrical characteristics</b> .....	<b>3</b>
<b>2.1</b>	<b>Electrical characteristics (curves)</b> .....	<b>5</b>
<b>3</b>	<b>Test circuits</b> .....	<b>9</b>
<b>4</b>	<b>Package information</b> .....	<b>10</b>
<b>4.1</b>	<b>TO-220 type A package information</b> .....	<b>10</b>
	<b>Revision history</b> .....	<b>12</b>

**IMPORTANT NOTICE – PLEASE READ CAREFULLY**

STMicroelectronics NV and its subsidiaries (“ST”) reserve the right to make changes, corrections, enhancements, modifications, and improvements to ST products and/or to this document at any time without notice. Purchasers should obtain the latest relevant information on ST products before placing orders. ST products are sold pursuant to ST’s terms and conditions of sale in place at the time of order acknowledgement.

Purchasers are solely responsible for the choice, selection, and use of ST products and ST assumes no liability for application assistance or the design of Purchasers’ products.

No license, express or implied, to any intellectual property right is granted by ST herein.

Resale of ST products with provisions different from the information set forth herein shall void any warranty granted by ST for such product.

ST and the ST logo are trademarks of ST. For additional information about ST trademarks, please refer to [www.st.com/trademarks](http://www.st.com/trademarks). All other product or service names are the property of their respective owners.

Information in this document supersedes and replaces information previously supplied in any prior versions of this document.

© 2020 STMicroelectronics – All rights reserved