

Trench gate field-stop, 650 V, 4 A, M series low-loss IGBT

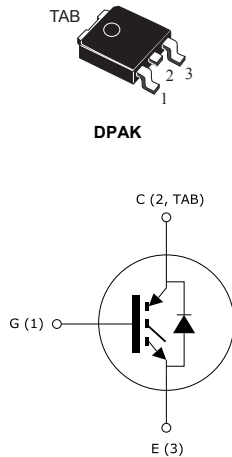

Features

- 6 μ s of short-circuit withstand time
- $V_{CE(sat)} = 1.6$ V (typ.) @ $I_C = 4$ A
- Tight parameter distribution
- Safer paralleling
- Low thermal resistance
- Soft and very fast recovery antiparallel diode

Applications

- Motor control
- UPS
- PFC

Description

This device is an IGBT developed using an advanced proprietary trench gate field-stop structure. The device is part of the M series IGBTs, which represent an optimal balance between inverter system performance and efficiency where the low-loss and the short-circuit functionality is essential. Furthermore, the positive $V_{CE(sat)}$ temperature coefficient and the tight parameter distribution result in safer paralleling operation.

Product status

STGD4M65DF2

Product summary

Order code	STGD4M65DF2
Marking	G4M65DF2
Package	DPAK
Packing	Tape and reel

1 Electrical ratings

Table 1. Absolute maximum ratings

Symbol	Parameter	Value	Unit
V_{CES}	Collector-emitter voltage ($V_{GE} = 0$ V)	650	V
I_C	Continuous collector current at $T_C = 25$ °C	8	A
	Continuous collector current at $T_C = 100$ °C	4	A
$I_{CP}^{(1)}$	Pulsed collector current	16	A
V_{GE}	Gate-emitter voltage	±20	V
I_F	Continuous forward current at $T_C = 25$ °C	8	A
	Continuous forward current at $T_C = 100$ °C	4	A
$I_{FP}^{(1)}$	Pulsed forward current	16	A
P_{TOT}	Total power dissipation at $T_C = 25$ °C	68	W
T_{STG}	Storage temperature range	- 55 to 150	°C
T_J	Operating junction temperature range	- 55 to 175	°C

1. Pulse width limited by maximum junction temperature.

Table 2. Thermal data

Symbol	Parameter	Value	Unit
R_{thJC}	Thermal resistance junction-case IGBT	2.2	°C/W
R_{thJC}	Thermal resistance junction-case diode	5	°C/W
R_{thJA}	Thermal resistance junction-ambient	100	°C/W

2 Electrical characteristics

$T_C = 25\text{ °C}$ unless otherwise specified

Table 3. Static characteristics

Symbol	Parameter	Test conditions	Min.	Typ.	Max.	Unit
$V_{(BR)CES}$	Collector-emitter breakdown voltage	$V_{GE} = 0\text{ V}, I_C = 250\text{ }\mu\text{A}$	650			V
$V_{CE(sat)}$	Collector-emitter saturation voltage	$V_{GE} = 15\text{ V}, I_C = 4\text{ A}$		1.6	2.1	V
		$V_{GE} = 15\text{ V}, I_C = 4\text{ A}, T_J = 125\text{ °C}$		1.9		
		$V_{GE} = 15\text{ V}, I_C = 4\text{ A}, T_J = 175\text{ °C}$		2.1		
V_F	Forward on-voltage	$I_F = 4\text{ A}$		1.9		V
		$I_F = 4\text{ A}, T_J = 125\text{ °C}$		1.7		
		$I_F = 4\text{ A}, T_J = 175\text{ °C}$		1.6		
$V_{GE(th)}$	Gate threshold voltage	$V_{CE} = V_{GE}, I_C = 250\text{ }\mu\text{A}$	5	6	7	V
I_{CES}	Collector cut-off current	$V_{GE} = 0\text{ V}, V_{CE} = 650\text{ V}$			25	μA
I_{GES}	Gate-emitter leakage current	$V_{CE} = 0\text{ V}, V_{GE} = \pm 20\text{ V}$			± 250	μA

Table 4. Dynamic characteristics

Symbol	Parameter	Test conditions	Min.	Typ.	Max.	Unit
C_{ies}	Input capacitance	$V_{CE} = 25\text{ V}, f = 1\text{ MHz}, V_{GE} = 0\text{ V}$	-	369	-	μF
C_{oes}	Output capacitance		-	24.8	-	
C_{res}	Reverse transfer capacitance		-	8	-	
Q_g	Total gate charge	$V_{CC} = 520\text{ V}, I_C = 4\text{ A}, V_{GE} = 0\text{ to }15\text{ V}$ (see Figure 29. Gate charge test circuit)	-	15.2	-	nC
Q_{ge}	Gate-emitter charge		-	3	-	
Q_{gc}	Gate-collector charge		-	7	-	

Table 5. IGBT switching characteristics (inductive load)

Symbol	Parameter	Test conditions	Min.	Typ.	Max.	Unit
$t_{d(on)}$	Turn-on delay time	$V_{CE} = 400\text{ V}$, $I_C = 4\text{ A}$, $V_{GE} = 15\text{ V}$, $R_G = 47\ \Omega$ (see Figure 28. Test circuit for inductive load switching)		12	-	ns
t_r	Current rise time			6.9	-	ns
$(di/dt)_{on}$	Turn-on current slope			480	-	A/ μ s
$t_{d(off)}$	Turn-off delay time			86	-	ns
t_f	Current fall time			120	-	ns
$E_{on}^{(1)}$	Turn-on switching energy			0.040	-	mJ
$E_{off}^{(2)}$	Turn-off switching energy			0.136	-	mJ
E_{ts}	Total switching energy			0.176	-	mJ
$t_{d(on)}$	Turn-on delay time		$V_{CE} = 400\text{ V}$, $I_C = 4\text{ A}$, $V_{GE} = 15\text{ V}$, $R_G = 47\ \Omega$, $T_J = 175\text{ }^\circ\text{C}$ (see Figure 28. Test circuit for inductive load switching)		11.6	-
t_r	Current rise time			8	-	ns
$(di/dt)_{on}$	Turn-on current slope			410	-	A/ μ s
$t_{d(off)}$	Turn-off delay time			85	-	ns
t_f	Current fall time			211	-	ns
$E_{on}^{(1)}$	Turn-on switching energy			0.067	-	mJ
$E_{off}^{(2)}$	Turn-off switching energy			0.210	-	mJ
E_{ts}	Total switching energy			0.277	-	mJ
t_{sc}	Short-circuit withstand time	$V_{CC} \leq 400\text{ V}$, $V_{GE} = 15\text{ V}$, $T_{Jstart} = 150\text{ }^\circ\text{C}$		6		-
		$V_{CC} \leq 400\text{ V}$, $V_{GE} = 13\text{ V}$, $T_{Jstart} = 150\text{ }^\circ\text{C}$	10		-	

1. Including the reverse recovery of the diode.
2. Including the tail of the collector current.

Table 6. Diode switching characteristics (inductive load)

Symbol	Parameter	Test conditions	Min.	Typ.	Max.	Unit
t_{rr}	Reverse recovery time	$I_F = 4\text{ A}$, $V_R = 400\text{ V}$, $V_{GE} = 15\text{ V}$, $di/dt = 800\text{ A}/\mu\text{s}$ (see Figure 28. Test circuit for inductive load switching)	-	133	-	ns
Q_{rr}	Reverse recovery charge		-	140	-	nC
I_{rrm}	Reverse recovery current		-	5	-	A
di_{rr}/dt	Peak rate of fall of reverse recovery current during t_b		-	520	-	A/ μ s
E_{rr}	Reverse recovery energy		-	15	-	μ J
t_{rr}	Reverse recovery time		$I_F = 4\text{ A}$, $V_R = 400\text{ V}$, $V_{GE} = 15\text{ V}$, $T_J = 175\text{ }^\circ\text{C}$, $di/dt = 800\text{ A}/\mu\text{s}$ (see Figure 28. Test circuit for inductive load switching)	-	236	-
Q_{rr}	Reverse recovery charge	-		370	-	nC
I_{rrm}	Reverse recovery current	-		6.6	-	A
di_{rr}/dt	Peak rate of fall of reverse recovery current during t_b	-		378	-	A/ μ s
E_{rr}	Reverse recovery energy	-		32	-	μ J

2.1 STGD4M65DF2 electrical characteristics (curves)

Figure 1. Power dissipation vs. case temperature

Figure 2. Collector current vs. case temperature

Figure 3. Output characteristics (T_J = 25 °C)

Figure 4. Output characteristics (T_J = 175 °C)

Figure 5. V_{CE(sat)} vs. junction temperature

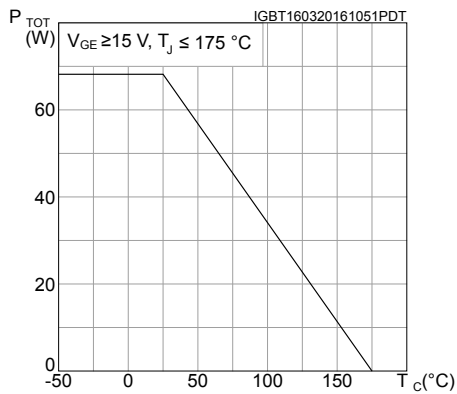
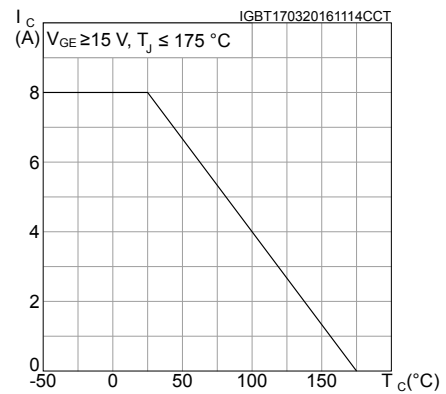
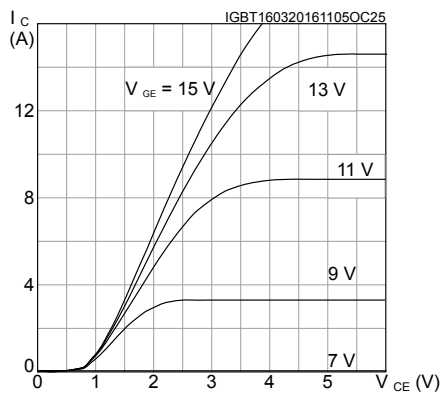
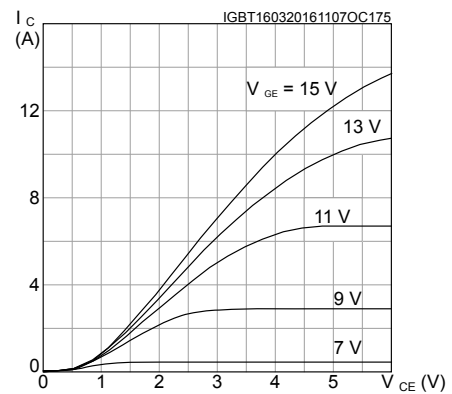
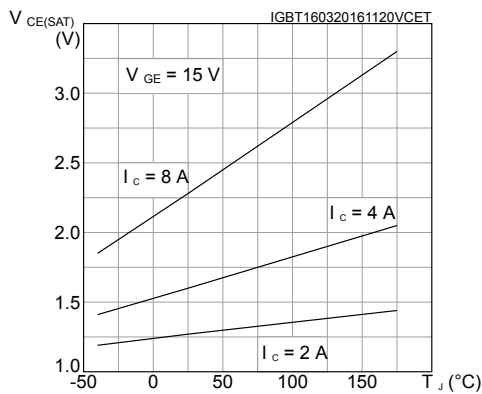
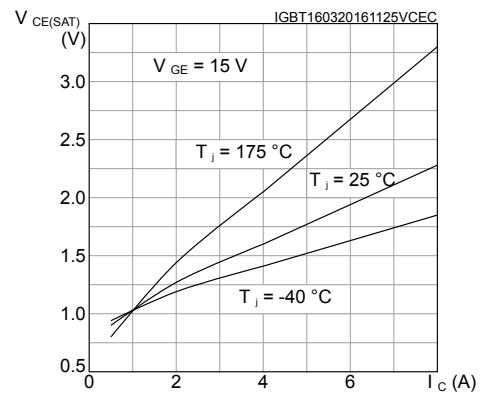
Figure 6. V_{CE(sat)} vs. collector current

Figure 7. Collector current vs. switching frequency

Figure 8. Forward bias safe operating area

Figure 9. Transfer characteristics

Figure 10. Diode Vf vs. forward current

Figure 11. Normalized VGE(th) vs. junction temperature

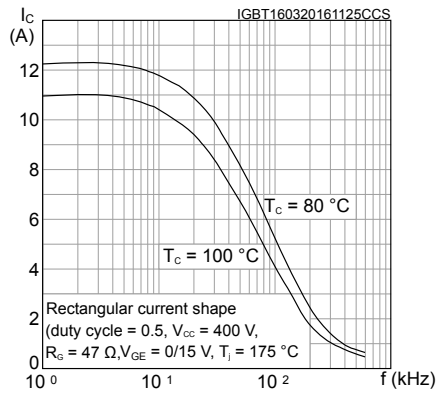
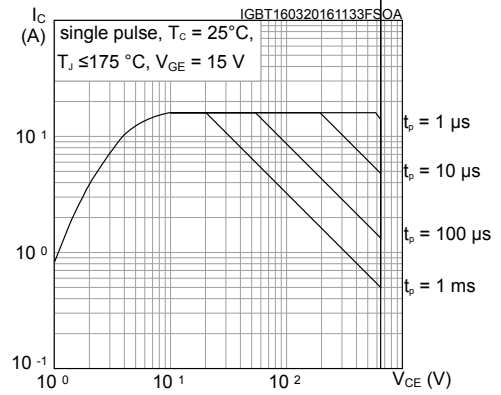
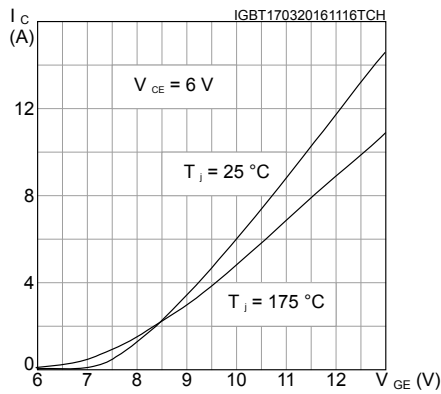
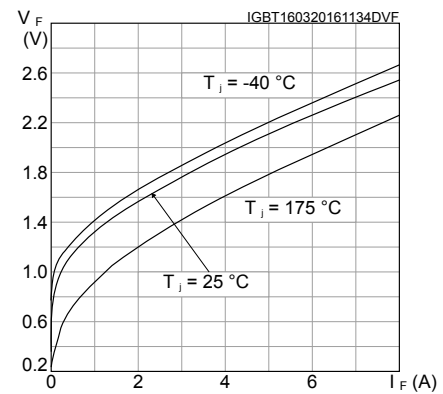
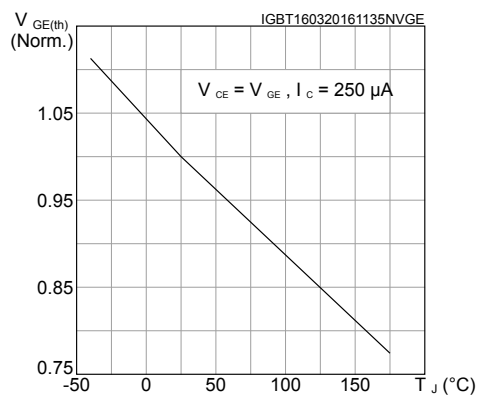
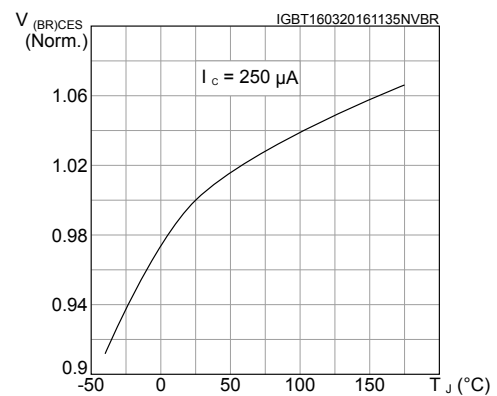
Figure 12. Normalized V(BR)CES vs. junction temperature

Figure 13. Capacitance variations

Figure 14. Gate charge vs. gate-emitter voltage

Figure 15. Switching energy vs. collector current

Figure 16. Switching energy vs. gate resistance

Figure 17. Switching energy vs. temperature

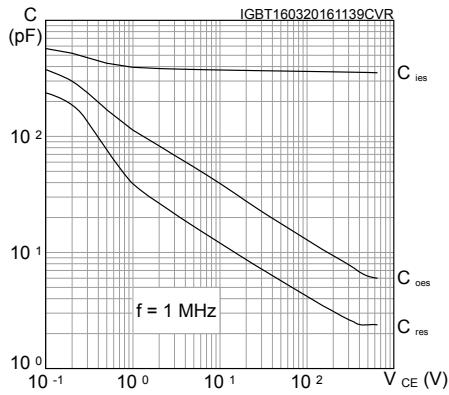
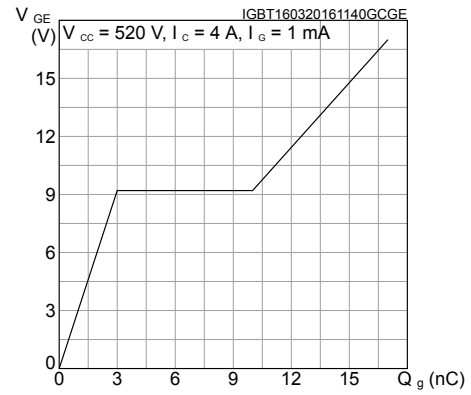
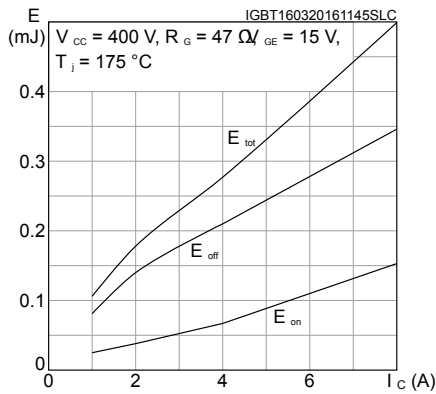
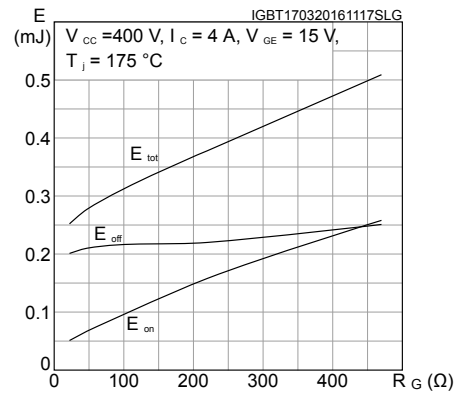
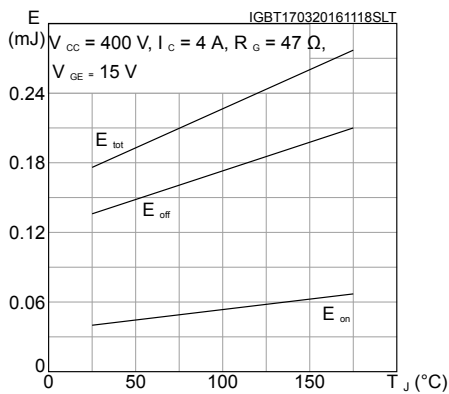
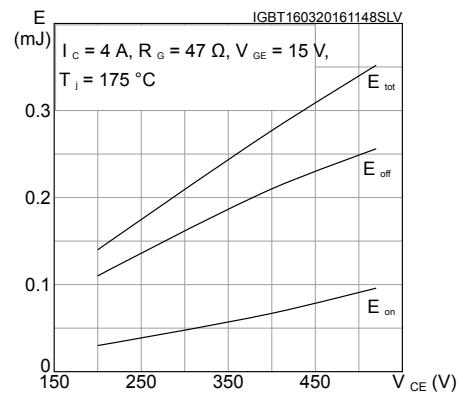
Figure 18. Switching energy vs. collector emitter voltage

Figure 19. Short-circuit time and current vs. V_{GE}

Figure 20. Switching times vs. collector current

Figure 21. Switching times vs. gate resistance

Figure 22. Reverse recovery current vs. diode current slope

Figure 23. Reverse recovery time vs. diode current slope

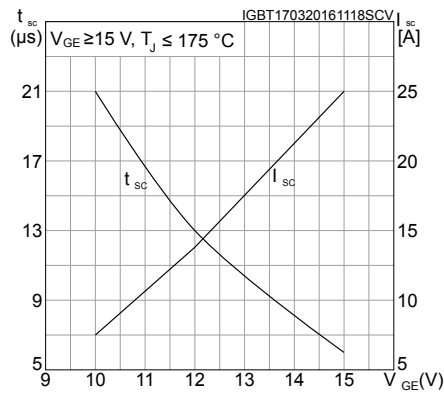
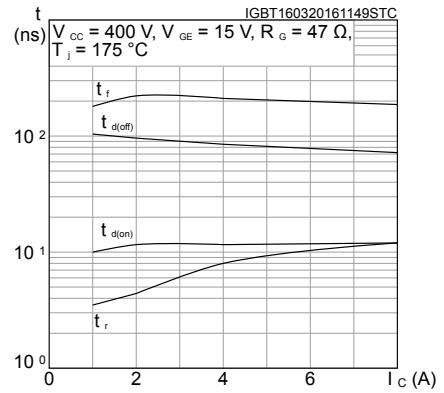
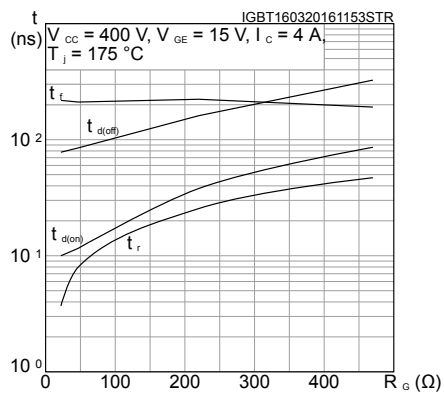
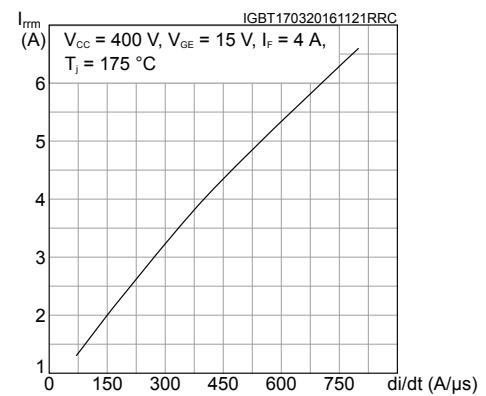
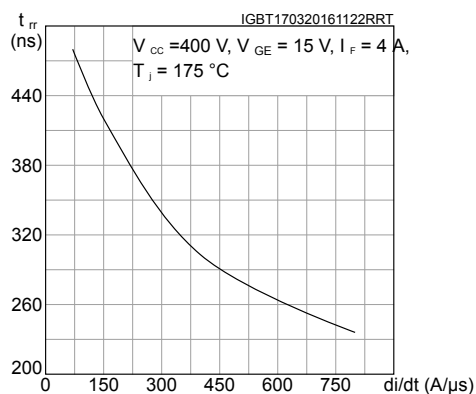
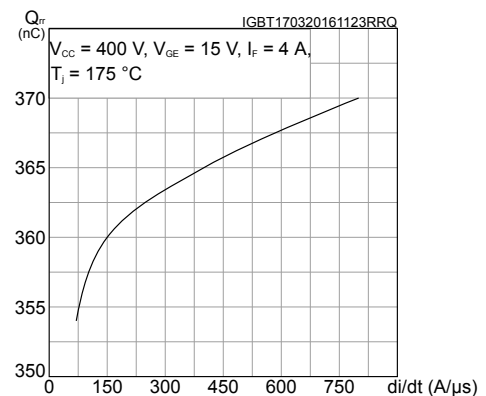
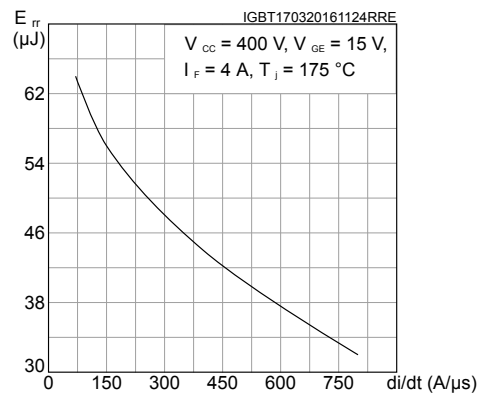
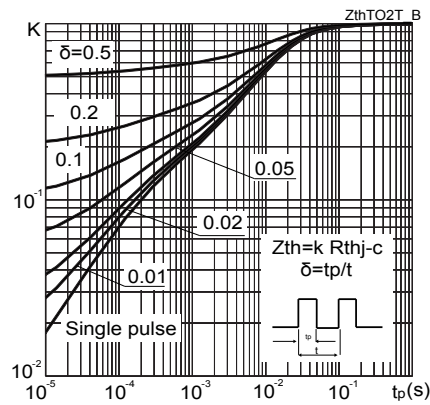
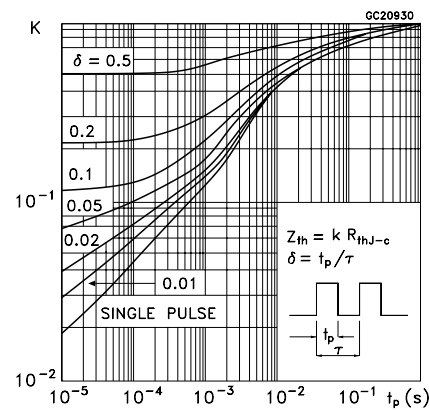
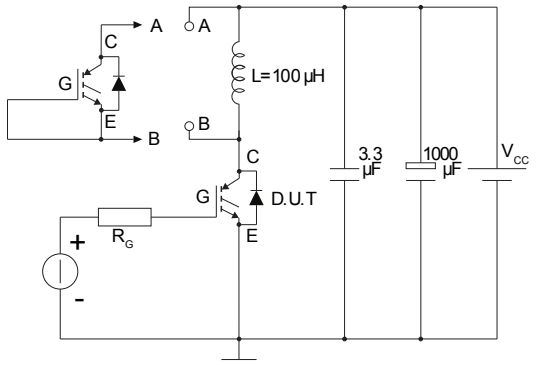
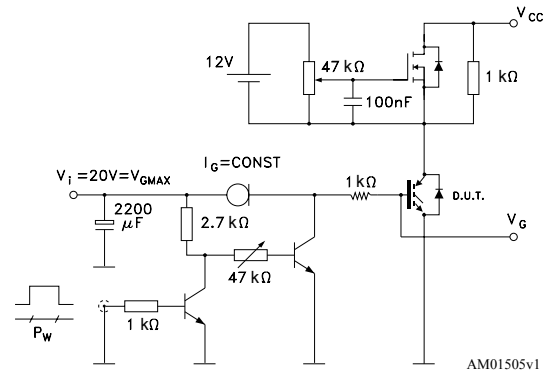
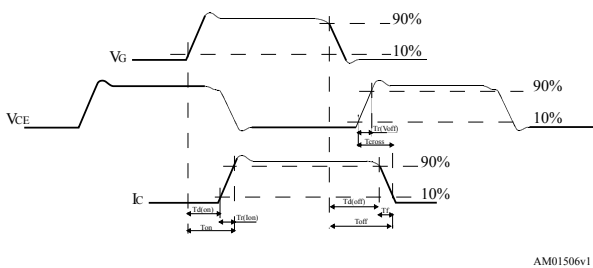
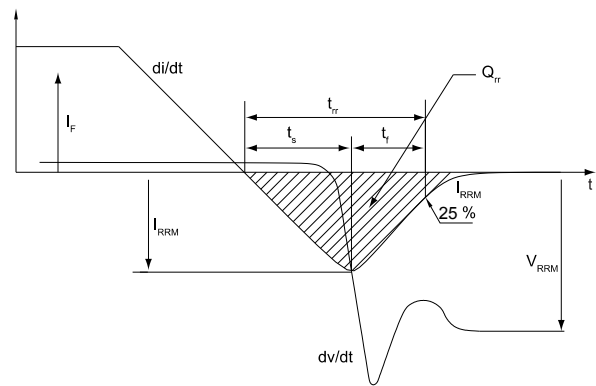
Figure 24. Reverse recovery charge vs. diode current slope

Figure 25. Reverse recovery energy vs. diode current slope

Figure 26. Thermal impedance for IGBT

Figure 27. Thermal impedance for diode

3 Test circuits

Figure 28. Test circuit for inductive load switching

Figure 29. Gate charge test circuit

Figure 30. Switching waveform

Figure 31. Diode reverse recovery waveform

4 Package information

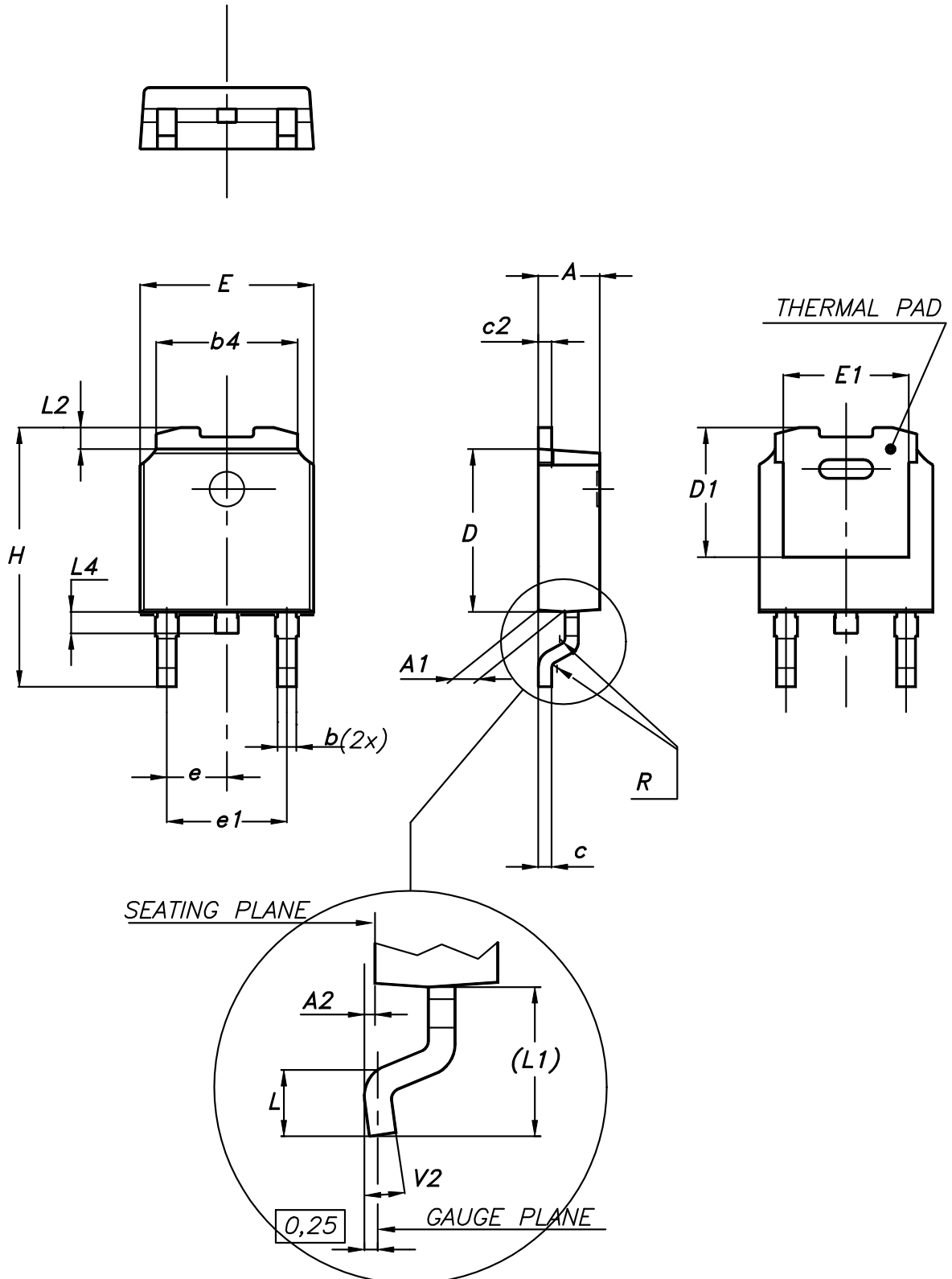
In order to meet environmental requirements, ST offers these devices in different grades of **ECOPACK[®]** packages, depending on their level of environmental compliance. ECOPACK[®] specifications, grade definitions and product status are available at: www.st.com. ECOPACK[®] is an ST trademark.

4.1 DPAK (TO-252) type A2 package information

Figure 32. DPAK (TO-252) type A2 package outline



0068772_type-A2_rev26

Table 7. DPAK (TO-252) type A2 mechanical data

Dim.	mm		
	Min.	Typ.	Max.
A	2.20		2.40
A1	0.90		1.10
A2	0.03		0.23
b	0.64		0.90
b4	5.20		5.40
c	0.45		0.60
c2	0.48		0.60
D	6.00		6.20
D1	4.95	5.10	5.25
E	6.40		6.60
E1	5.10	5.20	5.30
e	2.159	2.286	2.413
e1	4.445	4.572	4.699
H	9.35		10.10
L	1.00		1.50
L1	2.60	2.80	3.00
L2	0.65	0.80	0.95
L4	0.60		1.00
R		0.20	
V2	0°		8°

4.2 DPAK (TO-252) type C2 package information

Figure 33. DPAK (TO-252) type C2 package outline

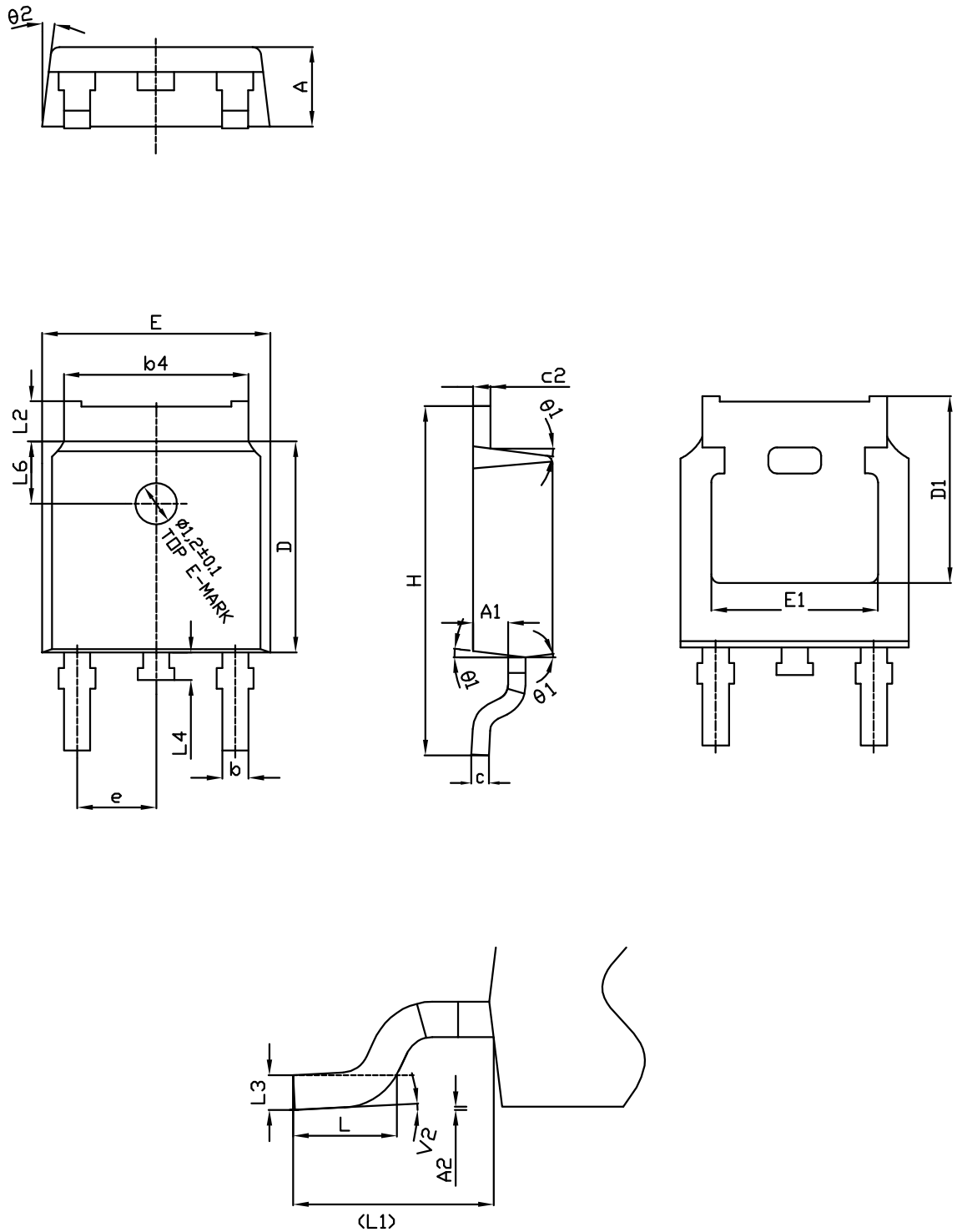

0068772_type-C2_rev26

Table 8. DPAK (TO-252) type C2 mechanical data

Dim.	mm		
	Min.	Typ.	Max.
A	2.20	2.30	2.38
A1	0.90	1.01	1.10
A2	0.00		0.10
b	0.72		0.85
b4	5.13	5.33	5.46
c	0.47		0.60
c2	0.47		0.60
D	6.00	6.10	6.20
D1	5.10		5.60
E	6.50	6.60	6.70
E1	5.20		5.50
e	2.186	2.286	2.386
H	9.80	10.10	10.40
L	1.40	1.50	1.70
L1	2.90 REF		
L2	0.90		1.25
L3	0.51 BSC		
L4	0.60	0.80	1.00
L6	1.80 BSC		
θ1	5°	7°	9°
θ2	5°	7°	9°
V2	0°		8°

Figure 34. DPAK (TO-252) recommended footprint (dimensions are in mm)

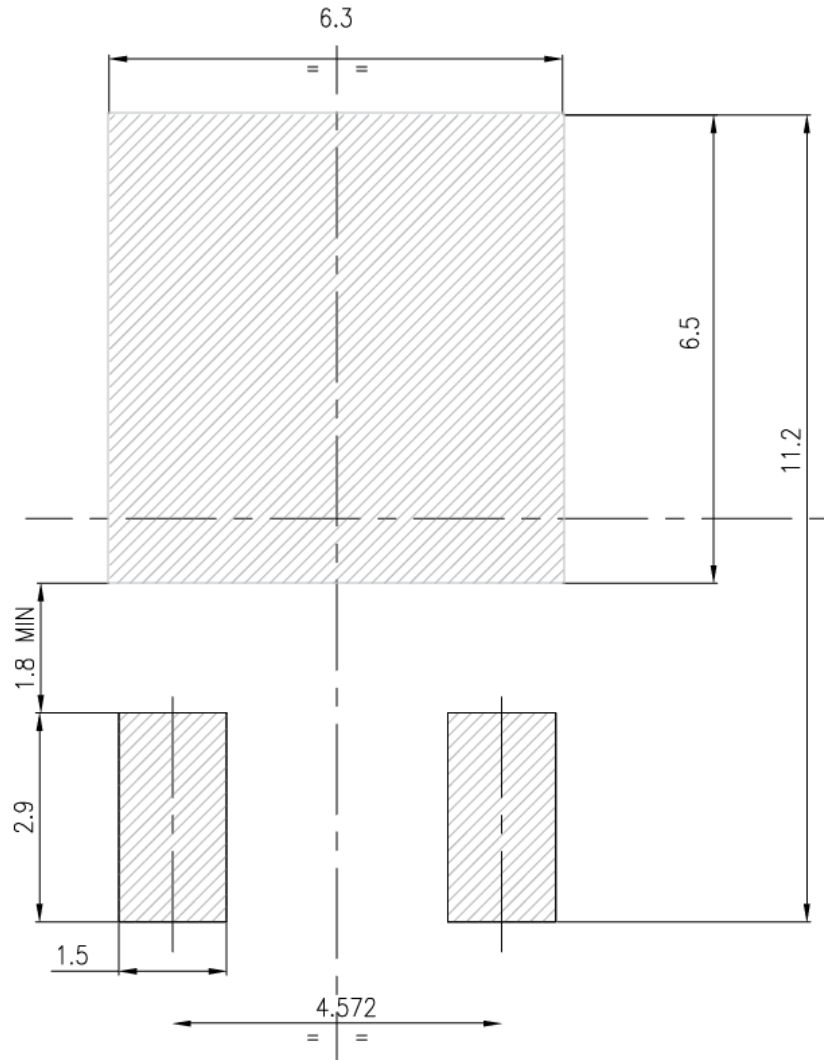

FP_0068772_rev26

4.3 DPAK (TO-252) packing information

Figure 35. DPAK (TO-252) tape outline

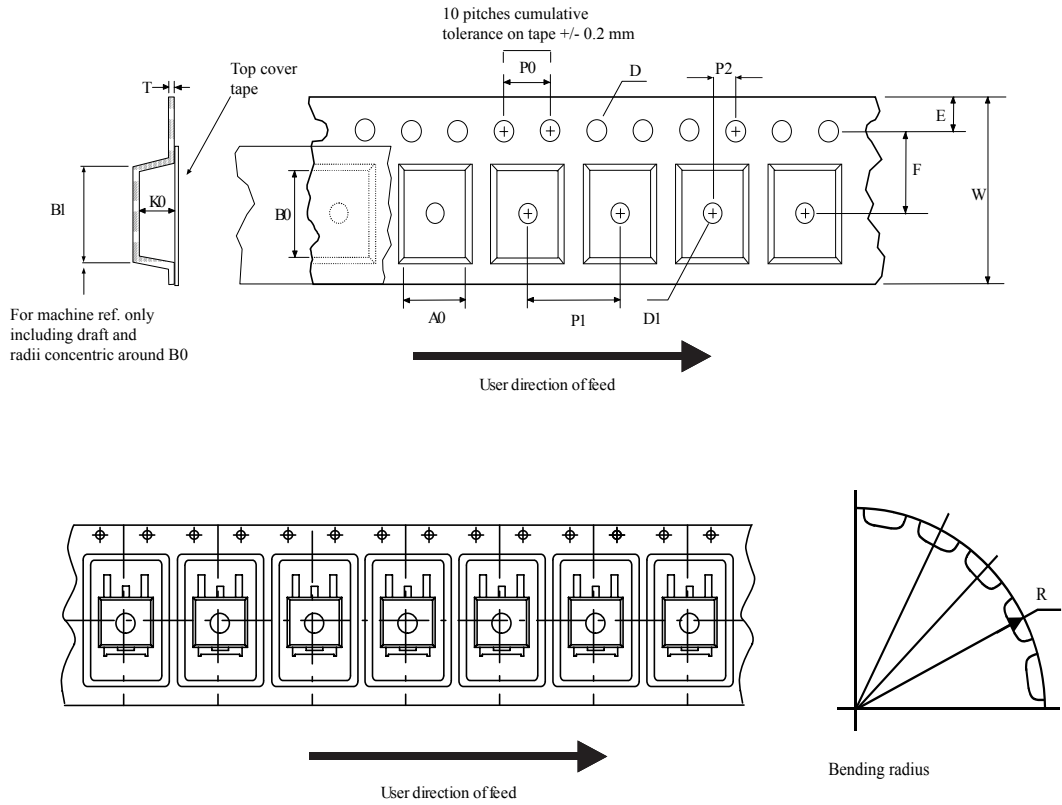

AM08852v1

Figure 36. DPAK (TO-252) reel outline

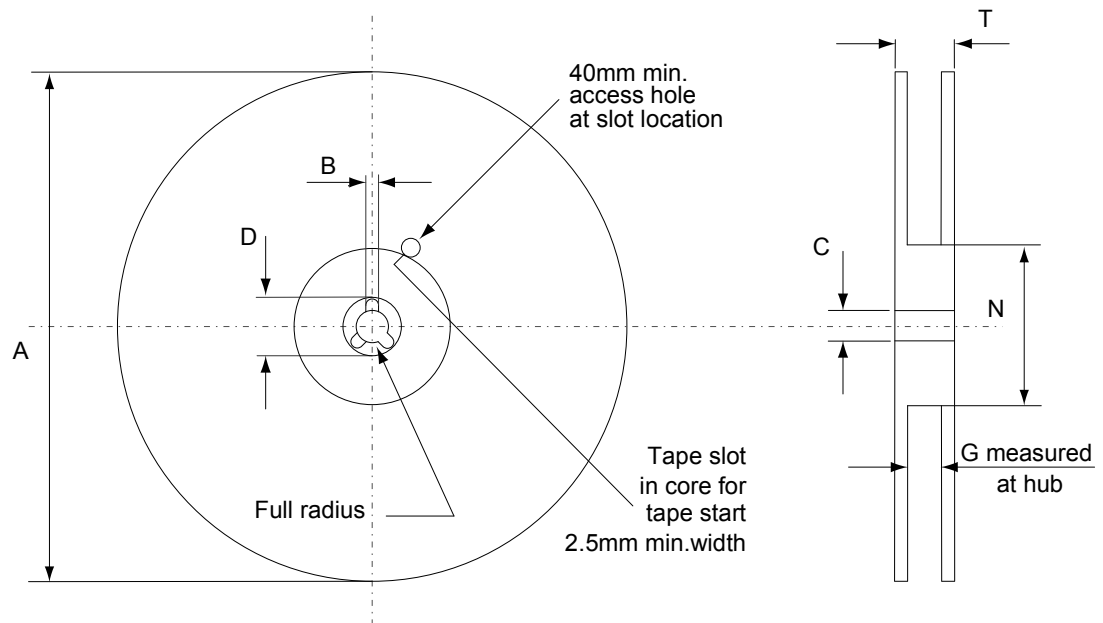

AM06038v1

Table 9. DPAK (TO-252) tape and reel mechanical data

Tape			Reel		
Dim.	mm		Dim.	mm	
	Min.	Max.		Min.	Max.
A0	6.8	7	A		330
B0	10.4	10.6	B	1.5	
B1		12.1	C	12.8	13.2
D	1.5	1.6	D	20.2	
D1	1.5		G	16.4	18.4
E	1.65	1.85	N	50	
F	7.4	7.6	T		22.4
K0	2.55	2.75			
P0	3.9	4.1	Base qty.		2500
P1	7.9	8.1	Bulk qty.		2500
P2	1.9	2.1			
R	40				
T	0.25	0.35			
W	15.7	16.3			

Revision history

Table 10. Document revision history

Date	Revision	Changes
25-Nov-2015	1	First release.
18-Apr-2016	2	Modified: features in cover page Modified: Table 2: " <i>Absolute maximum ratings</i> ", Table 4: " <i>Static characteristics</i> ", Table 5: " <i>Dynamic characteristics</i> ", Table 6: " <i>IGBT switching characteristics (inductive load)</i> " and Table 7: " <i>Diode switching characteristics (inductive load)</i> " Added: Section 2.1: " <i>Electrical characteristics (curves)</i> " Minor text changes
28-Apr-2016	3	Modified: Table 1: " <i>Device summary</i> " in cover page Minor text changes
21-Nov-2016	4	Updated Table 1. Absolute maximum ratings Updated Figure 24. Reverse recovery charge vs. diode current slope Updated Figure 31. Diode reverse recovery waveform
05-Dec-2018	5	Added Section 4.2 DPAK (TO-252) type C2 package information.

IMPORTANT NOTICE – PLEASE READ CAREFULLY

STMicroelectronics NV and its subsidiaries (“ST”) reserve the right to make changes, corrections, enhancements, modifications, and improvements to ST products and/or to this document at any time without notice. Purchasers should obtain the latest relevant information on ST products before placing orders. ST products are sold pursuant to ST’s terms and conditions of sale in place at the time of order acknowledgement.

Purchasers are solely responsible for the choice, selection, and use of ST products and ST assumes no liability for application assistance or the design of Purchasers’ products.

No license, express or implied, to any intellectual property right is granted by ST herein.

Resale of ST products with provisions different from the information set forth herein shall void any warranty granted by ST for such product.

ST and the ST logo are trademarks of ST. All other product or service names are the property of their respective owners.

Information in this document supersedes and replaces information previously supplied in any prior versions of this document.

© 2018 STMicroelectronics – All rights reserved