

SENSITIVE GATE SCR

FEATURES

- $I_{T(RMS)} = 1.4A$
- $V_{DRM} = 200V$ to $800V$
- Low $I_{GT} < 200 \mu A$

DESCRIPTION

The X02xxxN series of SCRs uses a high performance TOP GLASS PNP technology. These parts are intended for general purpose high volume applications using surface mount technology.

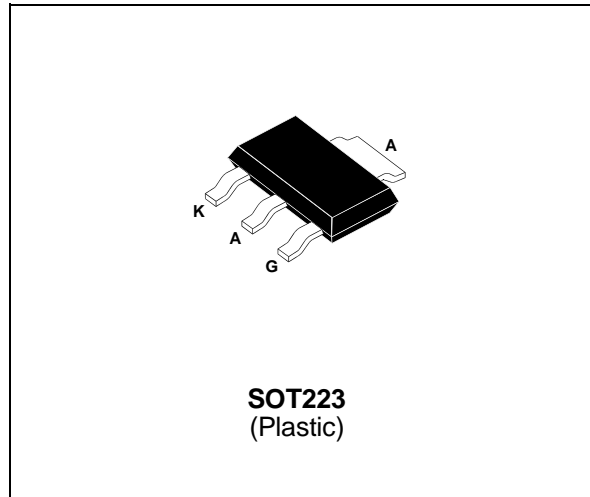

ABSOLUTE RATINGS (limiting values)

Symbol	Parameter	Value	Unit	
$I_{T(RMS)}$ *	RMS on-state current (180° conduction angle)	$T_{tab} = 90^{\circ}C$	1.4	A
		$T_a = 75^{\circ}C$	1.0	A
$I_{T(AV)}$ *	Mean on-state current (180° conduction angle)	$T_{tab} = 90^{\circ}C$	0.9	A
		$T_a = 75^{\circ}C$	0.64	A
I_{TSM}	Non repetitive surge peak on-state current (T_j initial = $25^{\circ}C$)	$t_p = 8.3$ ms	25	A
		$t_p = 10$ ms	22.5	A
I^2t	I^2t Value for fusing	$t_p = 10$ ms	2.5	A^2s
di/dt	Critical rate of rise of on-state current $I_G = 10$ mA $di_G/dt = 0.1$ A/ μs .	30	A/ μs	
T_{stg} T_j	Storage and operating junction temperature range	- 40, + 150 - 40, + 125	$^{\circ}C$	
TI	Maximum lead temperature for soldering during 10s	260	$^{\circ}C$	

* : With $5cm^2$ copper ($e=35\mu m$) surface under tab.

Symbol	Parameter	Voltage				Unit
		B	D	M	N	
V_{DRM} V_{RRM}	Repetitive peak off-state voltage $T_j = 125^{\circ}C$ $R_{GK} = 1K\Omega$	200	400	600	800	V

X02xxxN

THERMAL RESISTANCES

Symbol	Parameter	Value	Unit
Rth(j-a)	Junction to ambient *	60	°C/W
Rth(j-t)	Junction to tab for DC	25	°C/W

* : With 5cm² copper (e=35µm) surface under tab.

GATE CHARACTERISTICS (maximum values)

$P_{G(AV)} = 0.2 \text{ W}$ $P_{GM} = 3 \text{ W}$ ($t_p = 20 \mu\text{s}$) $I_{GM} = 1.2 \text{ A}$ ($t_p = 20 \mu\text{s}$)

ELECTRICAL CHARACTERISTICS

Symbol	Test Conditions				Sensitivity			Unit
					02	03	05	
I _{GT}	V _D =12V (DC) R _L =140Ω	T _j = 25°C	MIN		20	20	µA	
			MAX	200	200	50		
V _{GT}	V _D =12V (DC) R _L =140Ω	T _j = 25°C	MAX	0.8			V	
V _{GD}	V _D =V _{DRM} R _L =3.3kΩ R _{GK} = 1 KΩ	T _j = 125°C	MIN	0.1			V	
V _{RGM}	I _{RG} = 10µA	T _j = 25°C	MIN	8			V	
t _{gd}	V _D =V _{DRM} I _{TM} = 3 x I _{T(AV)} dI _G /dt = 0.1A/µs I _G = 10mA	T _j = 25°C	TYP	0.5			µs	
I _H	I _T = 50mA R _{GK} = 1 KΩ	T _j = 25°C	MAX	5			mA	
I _L	I _G =1mA R _{GK} = 1 KΩ	T _j = 25°C	MAX	6			mA	
V _{TM}	I _{TM} = 2.8A t _p = 380µs	T _j = 25°C	MAX	1.5			V	
I _{DRM} I _{RDM}	V _D = V _{DRM} R _{GK} = 1 KΩ V _R = V _{RDM}	T _j = 25°C	MAX	5			µA	
		T _j = 110°C	MAX	200			µA	
dV/dt	V _D =67%V _{DRM} R _{GK} = 1 KΩ	T _j = 110°C	TYP	15	20	15	V/µs	
t _q	I _{TM} = 3 x I _{T(AV)} V _R =35V dI/dt=10A/µs t _p =100µs dV/dt=2V/µs V _D = 67%V _{DRM} R _{GK} = 1 KΩ	T _j = 110°C	MAX	100			µs	

ORDERING INFORMATION

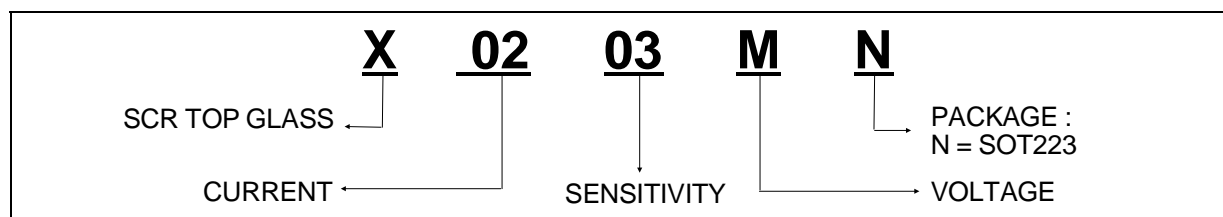

Fig.1 : Maximum average power dissipation versus average on-state current.

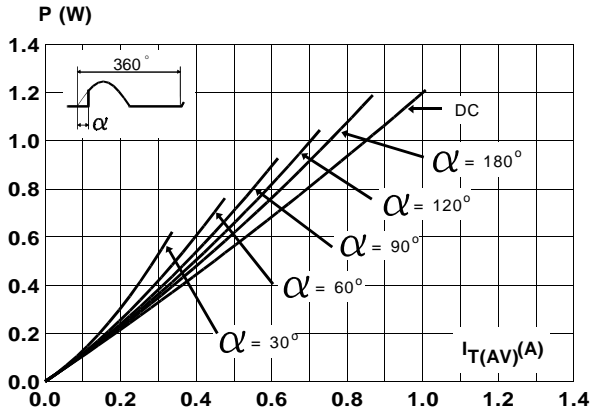

Fig.2 : Correlation between maximum average power dissipation and maximum allowable temperature (T_{amb} and T_{tab}).

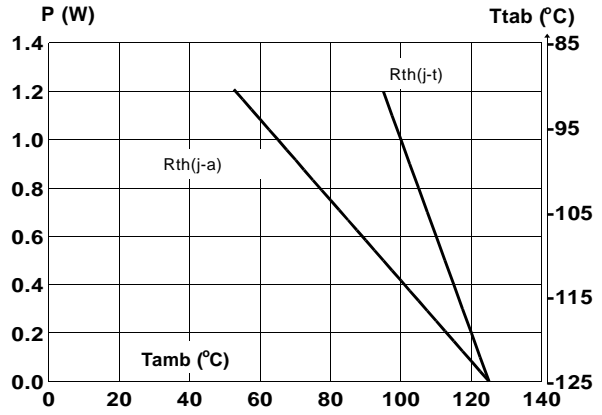

Fig.3 : Average on-state current versus tab temperature.

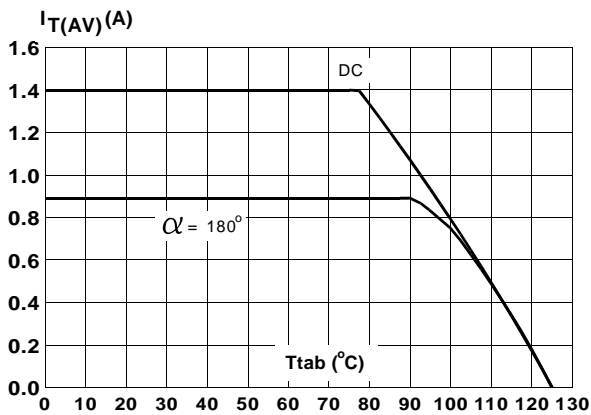

Fig.4 : Relative variation of thermal impedance junction to ambient versus pulse duration.

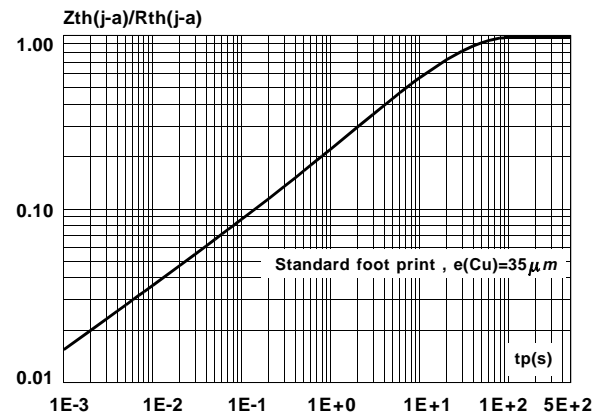

Fig.5 : Relative variation of gate trigger current and holding current versus junction temperature.

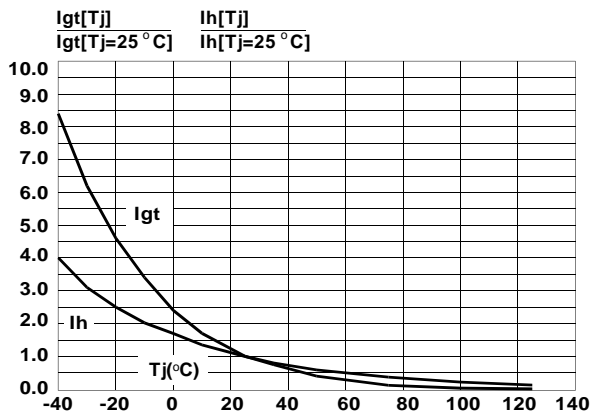
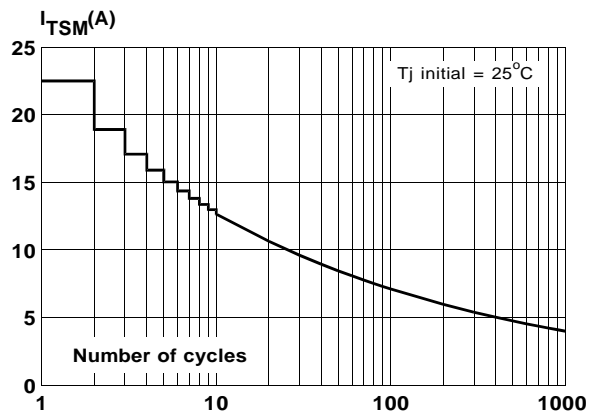

Fig.6 : Non repetitive surge peak on-state current versus number of cycles.



X02xxxN

Fig.7 : Non repetitive surge peak on-state current for a sinusoidal pulse with width : $t_p \leq 10\text{ms}$, and corresponding value of I^2t .

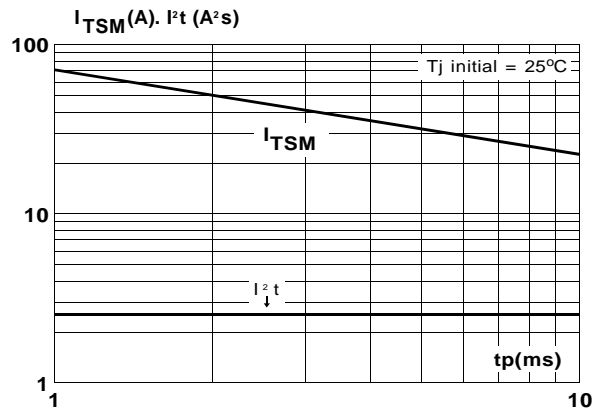
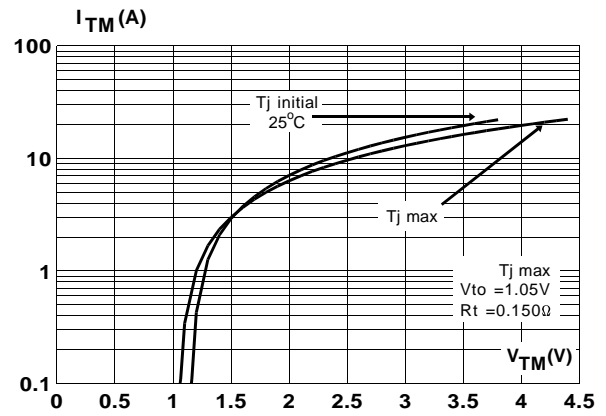
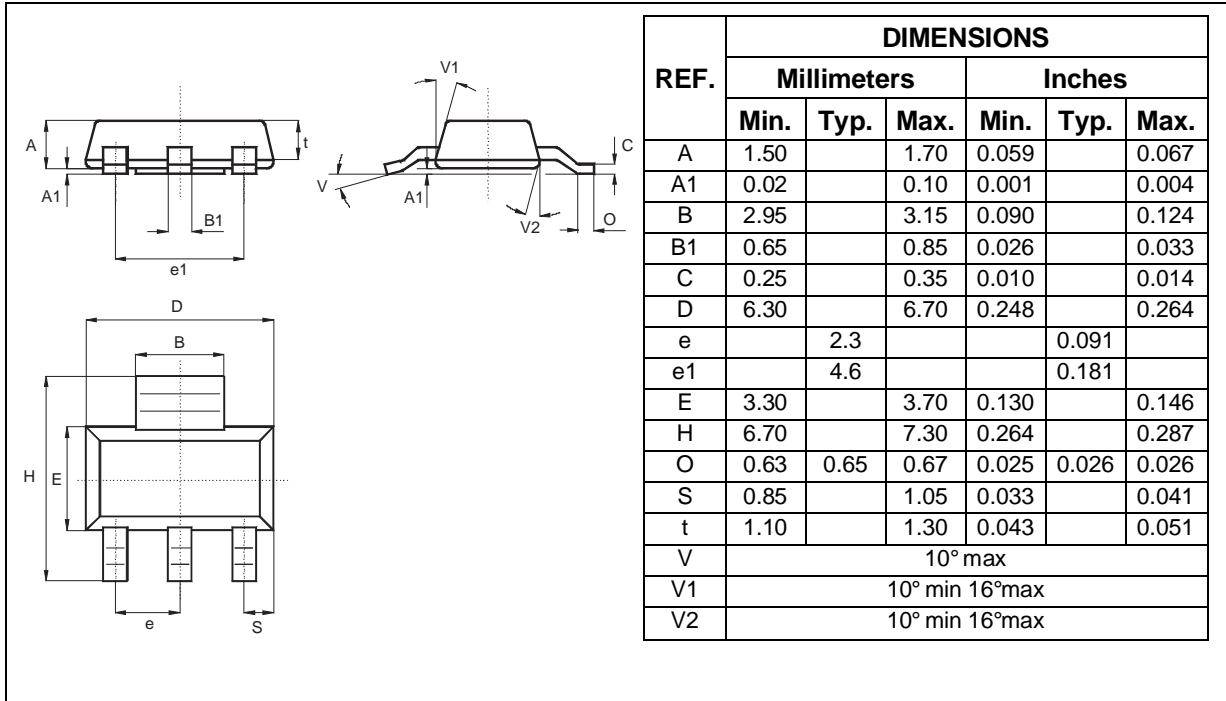

Fig.8 : On-state characteristics (maximum values).



PACKAGE MECHANICAL DATA
SOT223 (Plastic)



Weight : 0.11 g

MARKING

FOOT PRINT

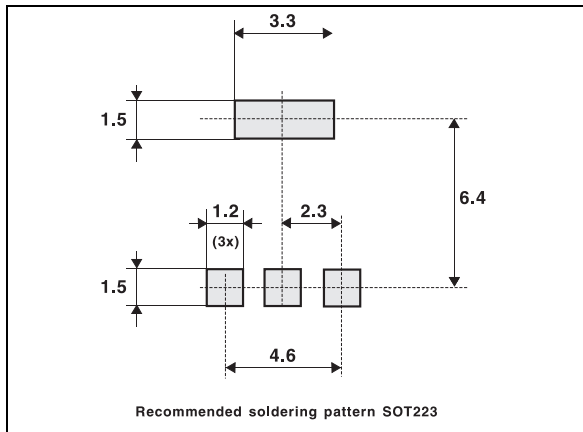

Type	Marking
X0202BN	X2B
X0202DN	X2D
X0202MN	X2M
X0202NN	X2N
X0203BN	X3B
X0203DN	X3D
X0203MN	X3M
X0203NN	X3N
X0205BN	X5B
X0205DN	X5D
X0205MN	X5M
X0205NN	X5N

Information furnished is believed to be accurate and reliable. However, STMicroelectronics assumes no responsibility for the consequences of use of such information nor for any infringement of patents or other rights of third parties which may result from its use. No license is granted by implication or otherwise under any patent or patent rights of STMicroelectronics. Specification mentioned in this publication are subject to change without notice. This publication supersedes and replaces all information previously supplied. STMicroelectronics products are not authorized for use as critical components in life support devices or systems without express written approval of STMicroelectronics.

The ST logo is a trademark of STMicroelectronics

© 1998 STMicroelectronics – Printed in Italy – All Rights Reserved

STMicroelectronics GROUP OF COMPANIES

Australia - Brazil - Canada - China - France - Germany - Italy - Japan - Korea - Malaysia - Malta - Morocco - The Netherlands - Singapore - Spain - Sweden - Switzerland - Taiwan - Thailand - United Kingdom - U.S.A.

