

## Transient protected AC switch (ACS™)

### Features

- Needs no external protection snubber or varistor
- Enables equipment to meet IEC 61000-4-5
- Reduces component count by up to 80%
- Interfaces directly with the microcontroller
- Common package tab connection supports connection of several alternating current switches (ACS) on the same cooling pad
- Integrated structure based on ASD technology
- Overvoltage protection by crowbar technology
- High noise immunity - static  $dV/dt > 300 \text{ V}/\mu\text{s}$

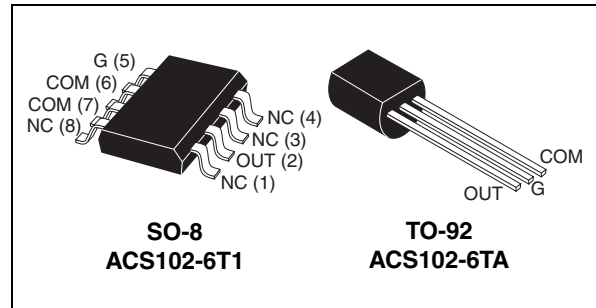
### Applications

- Alternating current on/off static switching in appliances and industrial control systems
- Drive of low-power, high-inductive or resistive loads like:
  - relay, valve, solenoid
  - dispenser, door lock
  - micro-motor

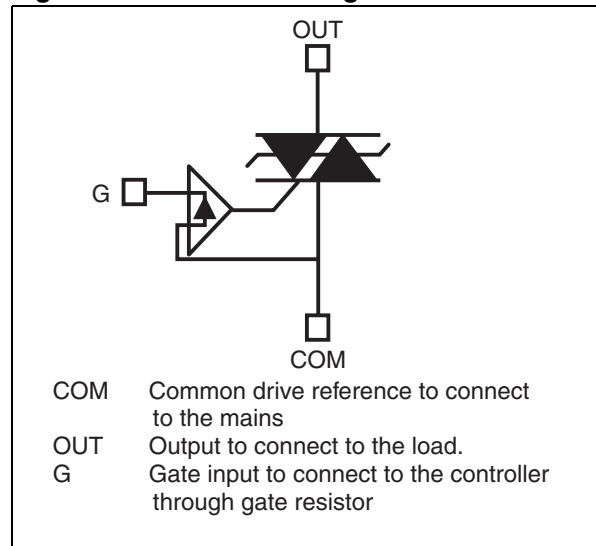
### Description

The ACS102-6T belongs to the AC line switch family. This high performance switch can control a load of up to 0.2A.

The ACS102-6T switch includes an overvoltage crowbar structure to absorb the overvoltage energy, and a gate level shifter driver to separate the digital controller from the main switch. It is triggered with a negative gate current flowing out of the gate pin.



**Figure 1. Functional diagram**



**Table 1. Device summary**

Symbol	Value	Unit
$I_{T(RMS)}$	0.2	A
$V_{DRM}/V_{RRM}$	600	V
$I_{GT}$	5	mA

TM: ACS is a trademark of STMicroelectronics

ASD: Application specific devices

# 1 Characteristics

**Table 2. Absolute maximum ratings ( $T_{amb} = 25\text{ °C}$ , unless otherwise specified)**

Symbol	Parameter		Value	Unit	
$I_{T(RMS)}$	On-state rms current (full sine wave)	TO-92	$T_{amb} = 100\text{ °C}$	0.2	A
		SO-08	$T_{amb} = 100\text{ °C}$		
$I_{TSM}$	Non repetitive surge peak on-state current (full cycle sine wave, $T_j$ initial = $25\text{ °C}$ )	f = 60 Hz	t = 16.7 ms	7.6	A
		f = 50 Hz	t = 20 ms	7.3	
$I^2t$	$I^2t$ Value for fusing	$t_p = 10\text{ ms}$		0.38	A <sup>2</sup> s
dI/dt	Critical rate of rise of on-state current $I_G = 2 \times I_{GT}$ , tr ≤ 100 ns	f = 120 Hz	$T_j = 125\text{ °C}$	50	A/μs
$V_{PP}$	Non repetitive line peak mains voltage <sup>(1)</sup>		$T_j = 25\text{ °C}$	2	kV
$I_{GM}$	Peak gate current	$t_p = 20\text{ μs}$	$T_j = 125\text{ °C}$	1	A
$V_{GM}$	Peak positive gate voltage		$T_j = 125\text{ °C}$	10	V
$P_{G(AV)}$	Average gate power dissipation		$T_j = 125\text{ °C}$	0.1	W
$T_{stg}$ $T_j$	Storage junction temperature range Operating junction temperature range			-40 to +150 -30 to +125	°C

1. According to test described by IEC 61000-4-5 standard and [Figure 17](#)

**Table 3. Electrical characteristics ( $T_j = 25\text{ °C}$ , unless otherwise specified)**

Symbol	Test conditions	Quadrant		Value	Unit
$I_{GT}^{(1)}$	$V_{OUT} = 12\text{ V}$ , $R_L = 33\text{ Ω}$	II - III	MAX	5	mA
$V_{GT}$				0.9	V
$V_{GD}$	$V_{OUT} = V_{DRM}$ , $R_L = 3.3\text{ kΩ}$ , $T_j = 125\text{ °C}$	II - III	MIN	0.15	V
$I_H^{(2)}$	$I_{OUT} = 100\text{ mA}$		MAX	20	mA
$I_L^{(2)}$	$I_G = 1.2 \times I_{GT}$		MAX	25	mA
dV/dt <sup>(2)</sup>	$V_{OUT} = 67\% V_{DRM}$ , gate open, $T_j = 125\text{ °C}$		MIN	300	V/μs
(dI/dt) <sub>C</sub> <sup>(2)</sup>	Without snubber (15 V/μs), turn-off time ≤ 20 ms, $T_j = 125\text{ °C}$		MIN	0.15	A/ms
$V_{CL}$	$I_{CL} = 0.1\text{ mA}$ , $t_p = 1\text{ ms}$ , $T_j = 125\text{ °C}$		MIN	650	V

1. Minimum  $I_{GT}$  is guaranteed at 10% of  $I_{GT}$  max

2. For both polarities of OUT referenced to COM

**Table 4. Static electrical characteristics**

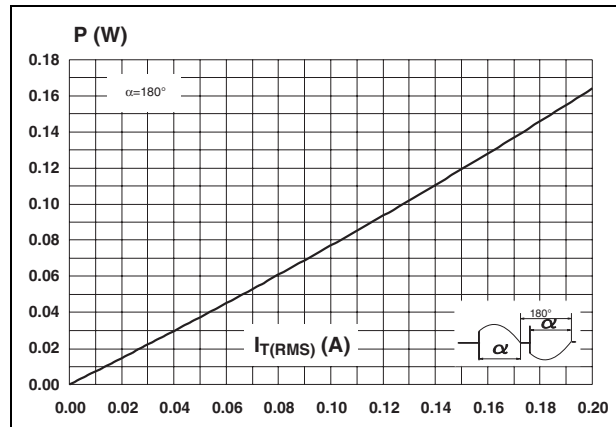
Symbol	Test conditions			Value	Unit
$V_{TM}^{(1)}$	$I_{TM} = 0.3 \text{ A}$ , $t_p = 380 \mu\text{s}$	$T_j = 25 \text{ }^\circ\text{C}$	MAX	1.2	V
$V_{TO}^{(1)}$		$T_j = 125 \text{ }^\circ\text{C}$	MAX	0.80	V
$R_D^{(1)}$		$T_j = 125 \text{ }^\circ\text{C}$	MAX	500	m $\Omega$
$I_{DRM}$ $I_{RRM}$	$V_{OUT} = 600 \text{ V}$	$T_j = 25 \text{ }^\circ\text{C}$	MAX	2	$\mu\text{A}$
		$T_j = 125 \text{ }^\circ\text{C}$		0.2	mA

1. for both polarities of OUT referenced to COM

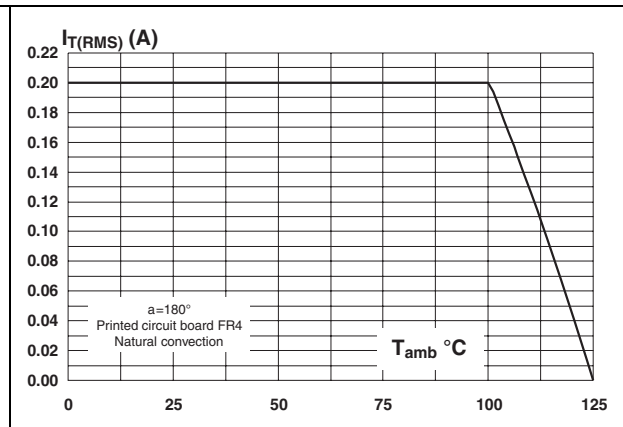
**Table 5. Thermal resistance**

Symbol	Parameter		Value	Unit
$R_{th(j-l)}$	Junction to lead (AC)	TO-92	60	$^\circ\text{C/W}$
$R_{th(j-a)}$	Junction to ambient	TO-92	150	
		$S = 40 \text{ mm}^2$ SO-8	150	

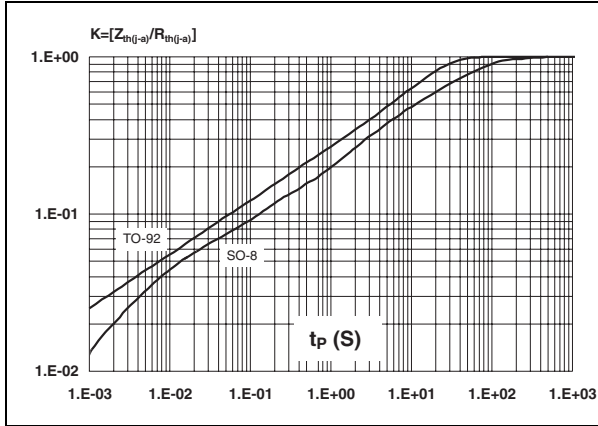
**Figure 2. Maximum power dissipation versus on-state rms current (full cycle)**



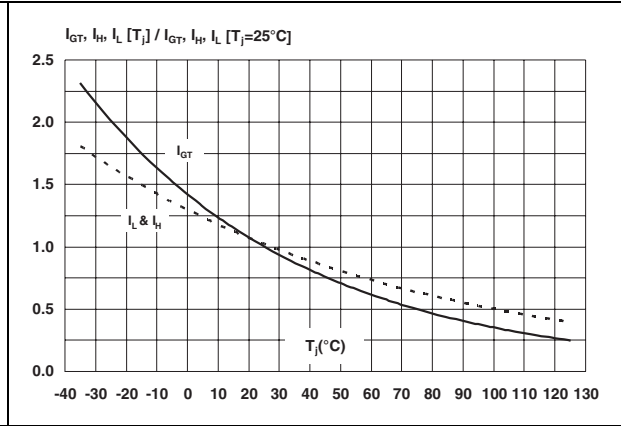
**Figure 3. On-state rms current versus ambient temperature (full cycle)**



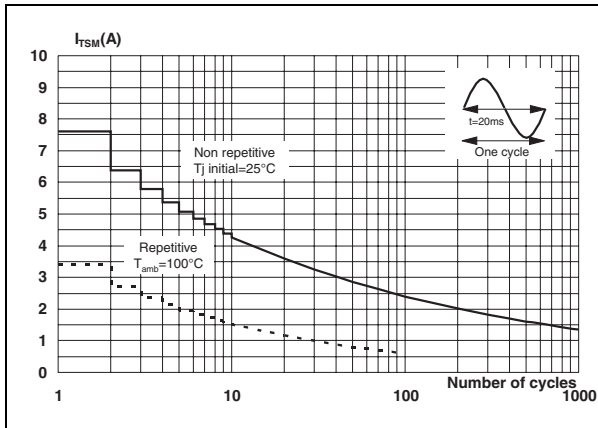
**Figure 4. Relative variation of junction to ambient thermal impedance versus pulse duration and package**



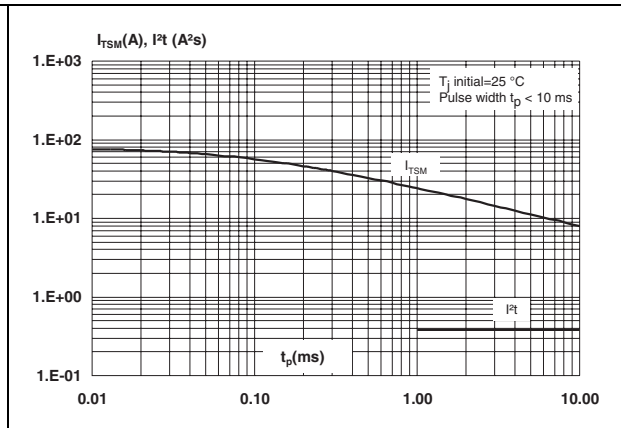
**Figure 5. Relative variation of gate trigger, holding and latching current versus junction temperature**



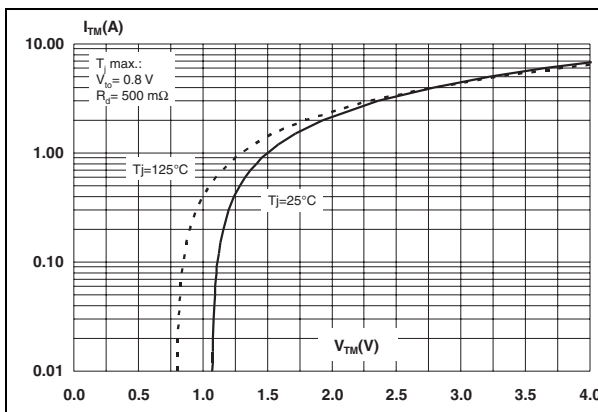
**Figure 6. Non repetitive surge peak on-state current versus number of cycles**



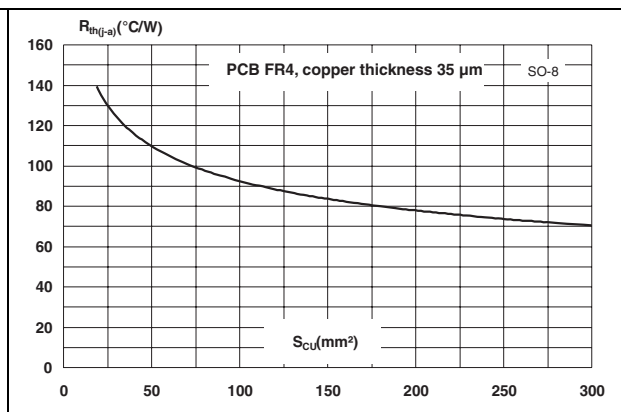
**Figure 7. Non repetitive surge peak on-state current for a sinusoidal pulse, and corresponding value of  $I^2t$**



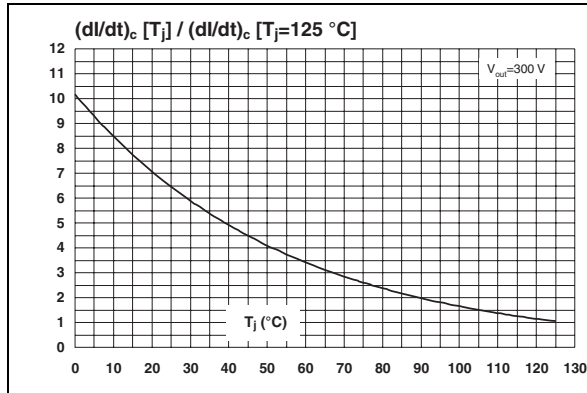
**Figure 8. On-state characteristics (maximal values)**



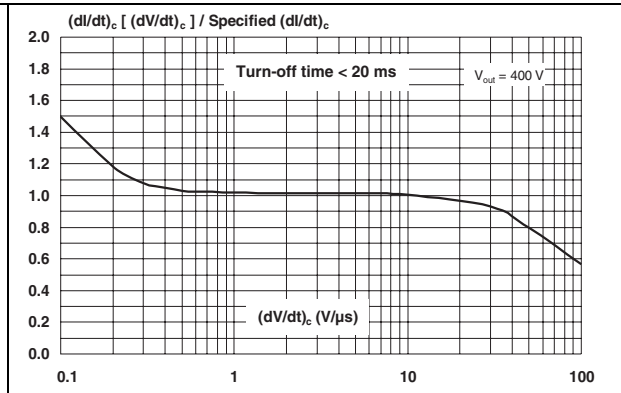
**Figure 9. SO-8 junction to ambient thermal resistance versus copper surface resistance under tab**



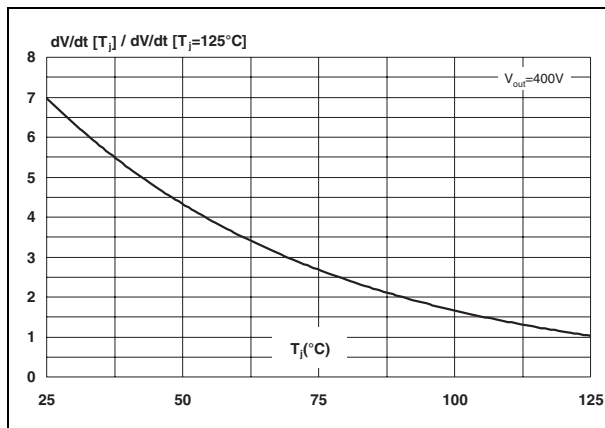
**Figure 10. Relative variation of critical rate of decrease of main current (di/dt)<sub>c</sub> versus junction temperature**



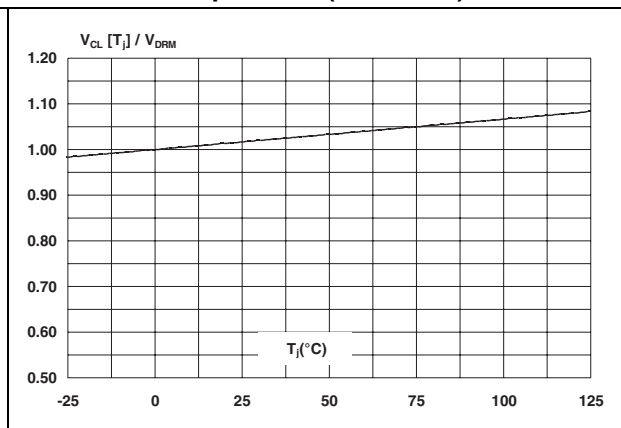
**Figure 11. Relative variation of critical rate of decrease of main current (di/dt)<sub>c</sub> versus (dV/dt)<sub>c</sub>**



**Figure 12. Relative variation of static dV/dt versus junction temperature**



**Figure 13. Relative variation of the maximal clamping voltage versus junction temperature (min value)**

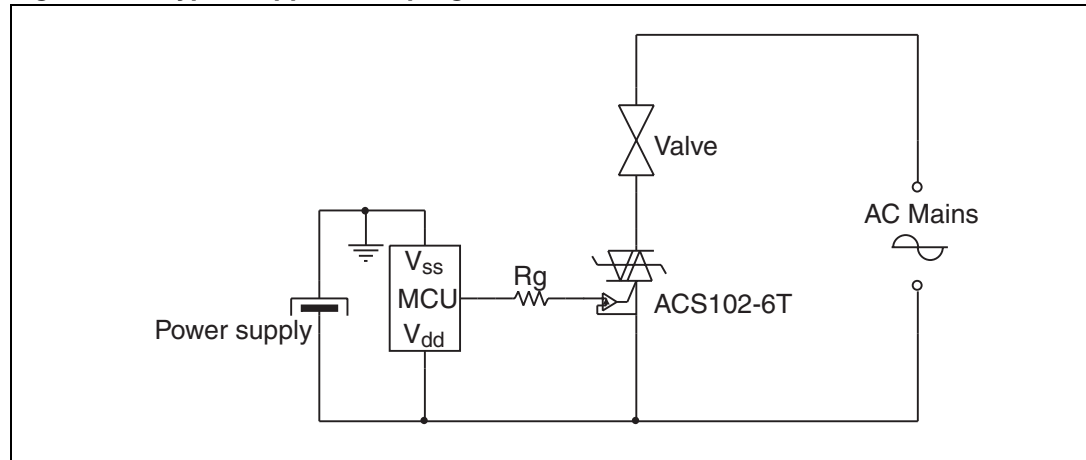


## 2 Alternating current line switch - basic application

The ACS102-6T switch is triggered by a negative gate current flowing from the gate pin G. The switch can be driven directly by the digital controller through a resistor as shown in [Figure 14](#).

Thanks to its overvoltage protection and turn-off commutation performance, the ACS102-6T switch can drive a small power, high-inductive load with neither varistor nor additional turn-off snubber.

**Figure 14. Typical application program**



### 2.1 Protection against overvoltage: the best choice is ACS

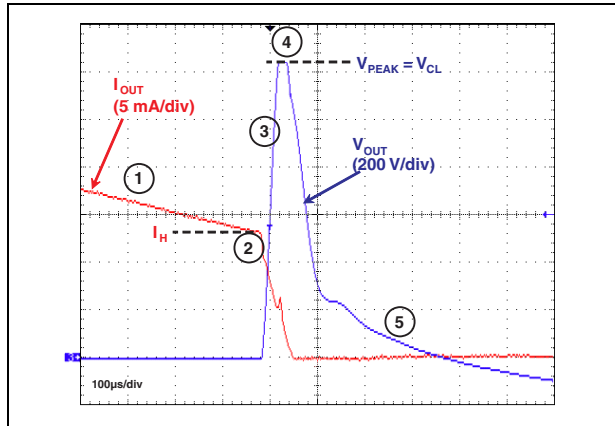
In comparison with standard TRIACs, which are not robust against surge voltage, the ACS102-6T is overvoltage self-protected, specified by the new parameter  $V_{CL}$ . This feature is useful in two operating conditions: in case of turn-off of very inductive load, and in case of surge voltage that can occur on the electrical network.

#### 2.1.1 High inductive load switch-off: turn-off overvoltage clamping

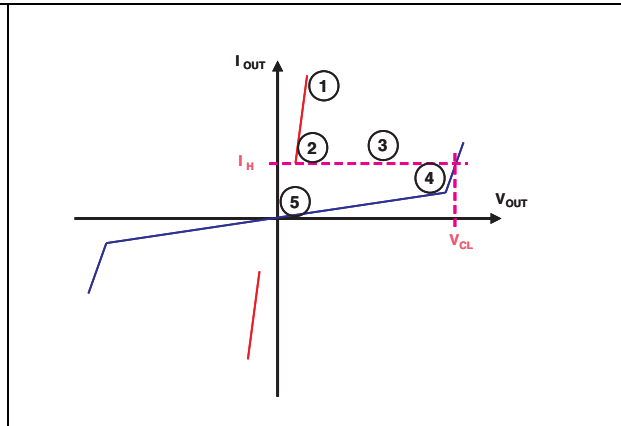
With high inductive and low rms current loads the rate of decrease of the current is very low. An overvoltage can occur when the gate current is removed and the OUT current is lower than  $I_H$ .

As shown in [Figure 15](#) and [Figure 16](#), at the end of the last conduction half cycle, the load current decreases (1). The load current reaches the holding current level  $I_H$  (2), and the ACS turns off (3). The water valve, as an inductive load (up to 15 H), reacts as a current generator and an overvoltage is created, which is clamped by the ACS (4). The current flows through the ACS avalanche and decreases linearly to zero. During this time, the voltage across the switch is limited to the clamping voltage  $V_{CL}$ . The energy stored in the inductance of the load is dissipated in the clamping section that is designed for this purpose. When the energy has been dissipated, the ACS voltage falls back to the mains voltage value (5).

**Figure 15. Effect of the switching off of a high inductive load - typical clamping capability of ACS102-6T**



**Figure 16. Description of the different steps during switching off of a high inductive load**



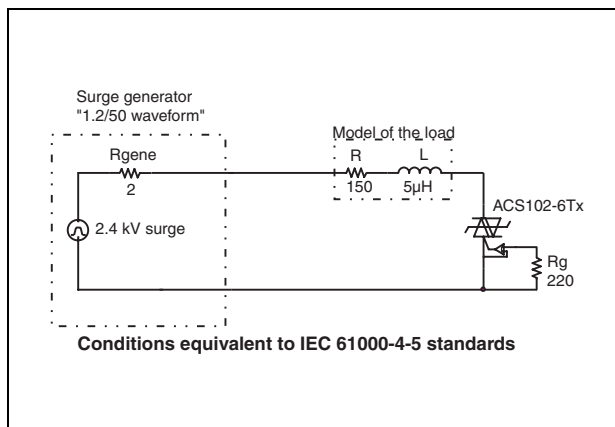
### 2.1.2 Alternating current line transient voltage ruggedness

The ACS102-6T switch is able to withstand safely the AC line transients either by clamping the low energy spikes or by breaking over under high energy shocks, even with high turn-on current rise.

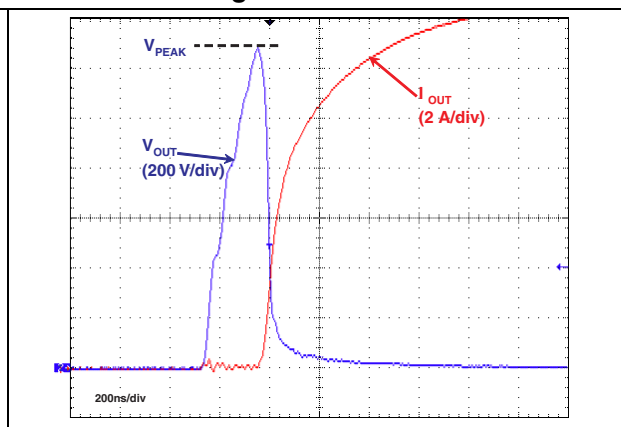
The test circuit shown in *Figure 17* is representative of the final ACS102-6T application, and is also used to test the ACS switch according to the IEC 61000-4-5 standard conditions. Thanks to the load limiting the current, the ACS102-6T switch withstands the voltage spikes up to 2 kV above the peak line voltage. The protection is based on an overvoltage crowbar technology. Actually, the ACS102-6T breaks over safely as shown in *Figure 18*. The ACS102-6T recovers its blocking voltage capability after the surge (switch off back at the next zero crossing of the current).

Such non-repetitive tests can be done 10 times on each AC line voltage polarity.

**Figure 17. Overvoltage ruggedness test circuit**

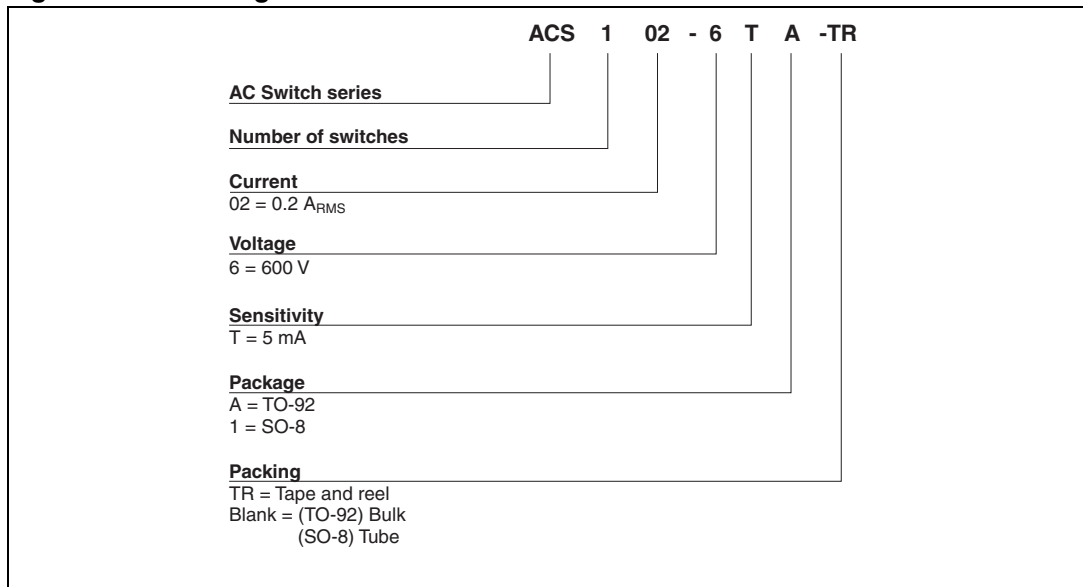


**Figure 18. Typical current and voltage waveforms across the ACS102-6T during IEC 61000-4-5 standard test**



### 3 Ordering information scheme

Figure 19. Ordering information scheme





## 4 Package information

- Epoxy meets UL94, V0
- Lead-free packages

In order to meet environmental requirements, ST offers these devices in different grades of ECOPACK® packages, depending on their level of environmental compliance. ECOPACK® specifications, grade definitions and product status are available at: [www.st.com](http://www.st.com). ECOPACK® is an ST trademark.

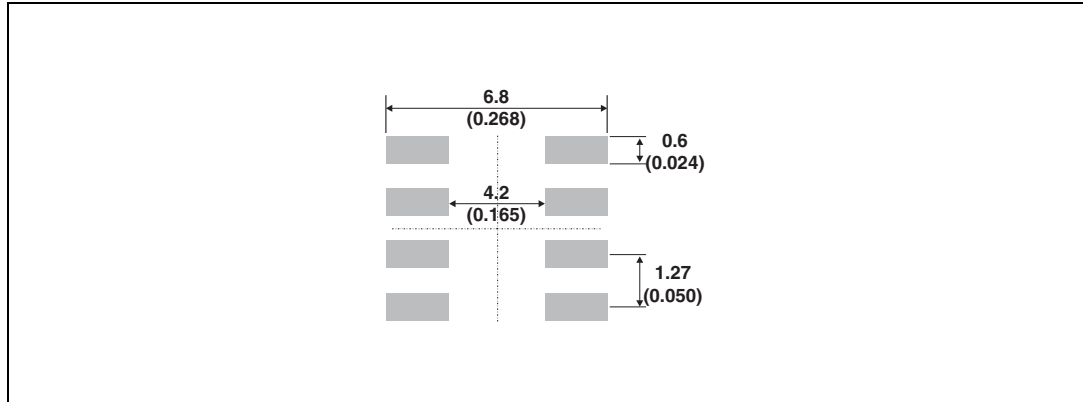
**Table 6. TO-92 dimensions**

Ref	Dimensions					
	Millimeters			Inches		
	Min.	Typ.	Max.	Min.	Typ.	Max.
A		1.35			0.053	
B			4.70			0.185
C		2.54			0.100	
D	4.40			0.173		
E	12.70			0.500		
F			3.70			0.146
a			0.50			0.019

**Table 7. SO-8 dimensions**

Ref.	Dimensions					
	Millimeters			Inches		
	Min.	Typ.	Max.	Min.	Typ.	Max.
A			1.75			0.069
A1	0.1		0.25	0.004		0.010
A2	1.25			0.049		
b	0.28		0.48	0.011		0.019
C	0.17		0.23	0.007		0.009
D	4.80	4.90	5.00	0.189	0.193	0.197
E	5.80	6.00	6.20	0.228	0.236	0.244
E1	3.80	3.90	4.00	0.150	0.154	0.157
e		1.27			0.050	
h	0.25		0.50	0.010		0.020
L	0.40		1.27	0.016		0.050
L1		1.04			0.041	
k	0°		8°	0°		8°
ppp			0.10			0.004

Figure 20. Footprint, dimensions in mm (inches)



## 5 Ordering information

Table 8. Ordering information

Order code	Marking	Package	Weight	Base qty	Packing mode
ACS102-6TA	ACS1026T	TO-92	0.2 g	2500	Bulk
ACS102-6TA-TR	ACS1026T	TO-92	0.2 g	2000	Tape and reel
ACS102-6T1	ACS1026T	SO-8	0.11 g	100	Tube
ACS102-6T1-TR	ACS1026T	SO-8	0.11 g	2500	Tape and reel

## 6 Revision history

Table 9. Document revision history

Date	Revision	Changes
05-Jan-2006	1	Initial release.
07-Jun-2006	2	Reformatted to current standards. Replaced <a href="#">Figure 9</a> .
24-May-2011	3	Added pin indications on first page. Corrected dimensions in <a href="#">Table 7</a> .

**Please Read Carefully:**

Information in this document is provided solely in connection with ST products. STMicroelectronics NV and its subsidiaries ("ST") reserve the right to make changes, corrections, modifications or improvements, to this document, and the products and services described herein at any time, without notice.

All ST products are sold pursuant to ST's terms and conditions of sale.

Purchasers are solely responsible for the choice, selection and use of the ST products and services described herein, and ST assumes no liability whatsoever relating to the choice, selection or use of the ST products and services described herein.

No license, express or implied, by estoppel or otherwise, to any intellectual property rights is granted under this document. If any part of this document refers to any third party products or services it shall not be deemed a license grant by ST for the use of such third party products or services, or any intellectual property contained therein or considered as a warranty covering the use in any manner whatsoever of such third party products or services or any intellectual property contained therein.

**UNLESS OTHERWISE SET FORTH IN ST'S TERMS AND CONDITIONS OF SALE ST DISCLAIMS ANY EXPRESS OR IMPLIED WARRANTY WITH RESPECT TO THE USE AND/OR SALE OF ST PRODUCTS INCLUDING WITHOUT LIMITATION IMPLIED WARRANTIES OF MERCHANTABILITY, FITNESS FOR A PARTICULAR PURPOSE (AND THEIR EQUIVALENTS UNDER THE LAWS OF ANY JURISDICTION), OR INFRINGEMENT OF ANY PATENT, COPYRIGHT OR OTHER INTELLECTUAL PROPERTY RIGHT.**

**UNLESS EXPRESSLY APPROVED IN WRITING BY AN AUTHORIZED ST REPRESENTATIVE, ST PRODUCTS ARE NOT RECOMMENDED, AUTHORIZED OR WARRANTED FOR USE IN MILITARY, AIR CRAFT, SPACE, LIFE SAVING, OR LIFE SUSTAINING APPLICATIONS, NOR IN PRODUCTS OR SYSTEMS WHERE FAILURE OR MALFUNCTION MAY RESULT IN PERSONAL INJURY, DEATH, OR SEVERE PROPERTY OR ENVIRONMENTAL DAMAGE. ST PRODUCTS WHICH ARE NOT SPECIFIED AS "AUTOMOTIVE GRADE" MAY ONLY BE USED IN AUTOMOTIVE APPLICATIONS AT USER'S OWN RISK.**

Resale of ST products with provisions different from the statements and/or technical features set forth in this document shall immediately void any warranty granted by ST for the ST product or service described herein and shall not create or extend in any manner whatsoever, any liability of ST.

ST and the ST logo are trademarks or registered trademarks of ST in various countries.

Information in this document supersedes and replaces all information previously supplied.

The ST logo is a registered trademark of STMicroelectronics. All other names are the property of their respective owners.

© 2011 STMicroelectronics - All rights reserved

STMicroelectronics group of companies

Australia - Belgium - Brazil - Canada - China - Czech Republic - Finland - France - Germany - Hong Kong - India - Israel - Italy - Japan - Malaysia - Malta - Morocco - Philippines - Singapore - Spain - Sweden - Switzerland - United Kingdom - United States of America

[www.st.com](http://www.st.com)

