

# BD435G, BD437G, BD439G, BD441G

## Plastic Medium-Power Silicon NPN Transistors

This series of plastic, medium-power silicon NPN transistors can be used for amplifier and switching applications.

### Features

- Complementary Types are BD438 and BD442
- These Devices are Pb-Free and are RoHS Compliant\*

### MAXIMUM RATINGS

Rating	Symbol	Value	Unit
Collector-Emitter Voltage BD435G BD437G BD439G BD441G	$V_{CEO}$	32 45 60 80	Vdc
Collector-Base Voltage BD435G BD437G BD439G BD441G	$V_{CBO}$	32 45 60 80	Vdc
Emitter-Base Voltage	$V_{EBO}$	5.0	Vdc
Collector Current	$I_C$	4.0	Adc
Base Current	$I_B$	1.0	Adc
Total Device Dissipation @ $T_C = 25^\circ\text{C}$ Derate above $25^\circ\text{C}$	$P_D$	36 288	W W/ $^\circ\text{C}$
Operating and Storage Junction Temperature Range	$T_J, T_{stg}$	-55 to +150	$^\circ\text{C}$

Stresses exceeding those listed in the Maximum Ratings table may damage the device. If any of these limits are exceeded, device functionality should not be assumed, damage may occur and reliability may be affected.

### THERMAL CHARACTERISTICS

Characteristic	Symbol	Max	Unit
Thermal Resistance, Junction-to-Case	$R_{\theta JC}$	3.5	$^\circ\text{C/W}$

\*For additional information on our Pb-Free strategy and soldering details, please download the ON Semiconductor Soldering and Mounting Techniques Reference Manual, SOLDERRM/D.



**ON Semiconductor®**

<http://onsemi.com>

## 4.0 AMPERES POWER TRANSISTORS NPN SILICON

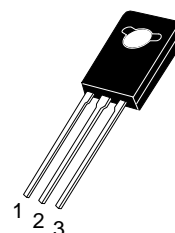
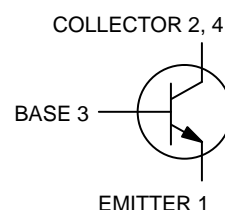

TO-225  
CASE 77-09  
STYLE 1

### MARKING DIAGRAM



Y = Year  
 WW = Work Week  
 BD4xx = Device Code  
       xx = 35, 37, 37T, 39, 41  
 G = Pb-Free Package

### ORDERING INFORMATION

Device	Package	Shipping
BD435G	TO-225 (Pb-Free)	500 Units/Box
BD437G	TO-225 (Pb-Free)	500 Units/Box
BD437TG	TO-225 (Pb-Free)	50 Units/Rail
BD439G	TO-225 (Pb-Free)	500 Units/Box
BD441G	TO-225 (Pb-Free)	500 Units/Box

# BD435G, BD437G, BD439G, BD441G

## ELECTRICAL CHARACTERISTICS (T<sub>C</sub> = 25°C unless otherwise noted)

Characteristic	Symbol	Min	Typ	Max	Unit
Collector–Emitter Breakdown Voltage (I <sub>C</sub> = 100 mA, I <sub>B</sub> = 0) BD435G BD437G BD439G BD441G	V <sub>(BR)CEO</sub>	32 45 60 80	– – – –	– – – –	Vdc
Collector–Base Breakdown Voltage (I <sub>C</sub> = 100 μA, I <sub>B</sub> = 0) BD435G BD437G BD439G BD441G	V <sub>(BR)CBO</sub>	32 45 60 80	– – – –	– – – –	Vdc
Emitter–Base Breakdown Voltage (I <sub>E</sub> = 100 μA, I <sub>C</sub> = 0)	V <sub>(BR)EBO</sub>	5.0	–	–	Vdc
Collector Cutoff Current (V <sub>CB</sub> = 32 V, I <sub>E</sub> = 0) BD435G (V <sub>CB</sub> = 45 V, I <sub>E</sub> = 0) BD437G (V <sub>CB</sub> = 60 V, I <sub>E</sub> = 0) BD439G (V <sub>CB</sub> = 80 V, I <sub>E</sub> = 0) BD441G	I <sub>CBO</sub>	– – – –	– – – –	0.1 0.1 0.1 0.1	mAdc
Emitter Cutoff Current (V <sub>EB</sub> = 5.0 V)	I <sub>EBO</sub>	–	–	1.0	mAdc
DC Current Gain (I <sub>C</sub> = 10 mA, V <sub>CE</sub> = 5.0 V) BD435G BD437G BD439G BD441G	h <sub>FE</sub>	40 30 20 15	– – – –	– – – –	–
DC Current Gain (I <sub>C</sub> = 500 mA, V <sub>CE</sub> = 1.0 V) BD435G BD437G BD439G, BD441G	h <sub>FE</sub>	85 85 40	– – –	475 375 475	–
DC Current Gain (I <sub>C</sub> = 2.0 A, V <sub>CE</sub> = 1.0 V) BD435G BD437G BD439G BD441G	h <sub>FE</sub>	50 40 25 15	– – – –	– – – –	–
Collector Saturation Voltage (I <sub>C</sub> = 2.0 A, I <sub>B</sub> = 0.2 V) BD435G (I <sub>C</sub> = 3.0 A, I <sub>B</sub> = 0.3 A) BD437G, BD439G, BD441G	V <sub>CE(sat)</sub>	– –	– –	0.5 0.8	Vdc
Base–Emitter On Voltage (I <sub>C</sub> = 2.0 A, V <sub>CE</sub> = 1.0 V)	V <sub>BE(on)</sub>	–	–	1.1	Vdc
Current–Gain – Bandwidth Product (V <sub>CE</sub> = 1.0 V, I <sub>C</sub> = 250 mA, f = 1.0 MHz)	f <sub>T</sub>	3.0	–	–	MHz

Product parametric performance is indicated in the Electrical Characteristics for the listed test conditions, unless otherwise noted. Product performance may not be indicated by the Electrical Characteristics if operated under different conditions.

BD435G, BD437G, BD439G, BD441G

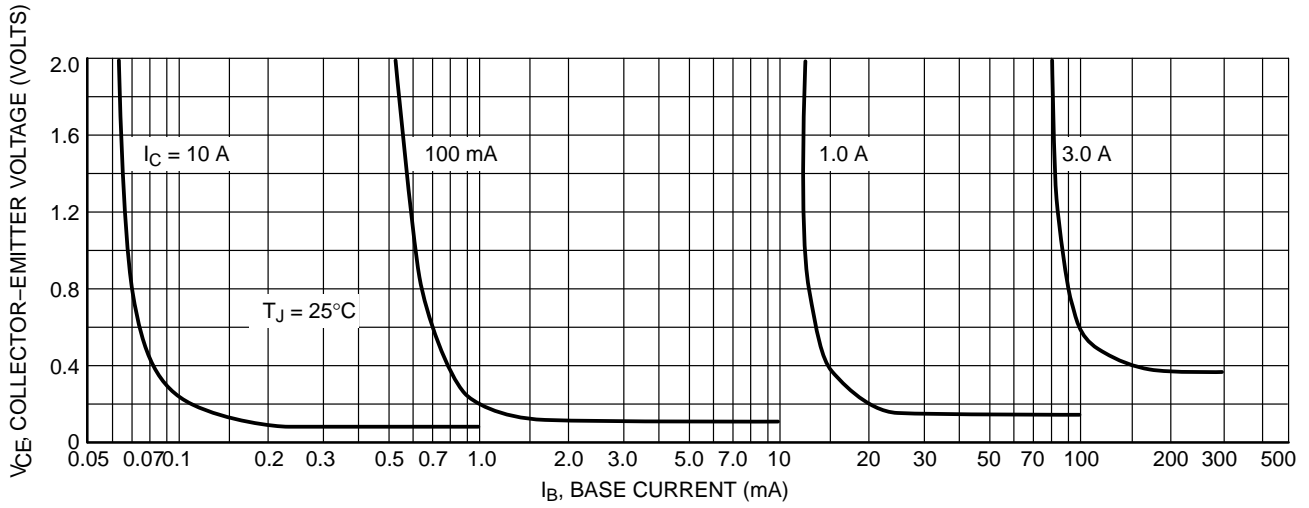

Figure 1. Collector Saturation Region

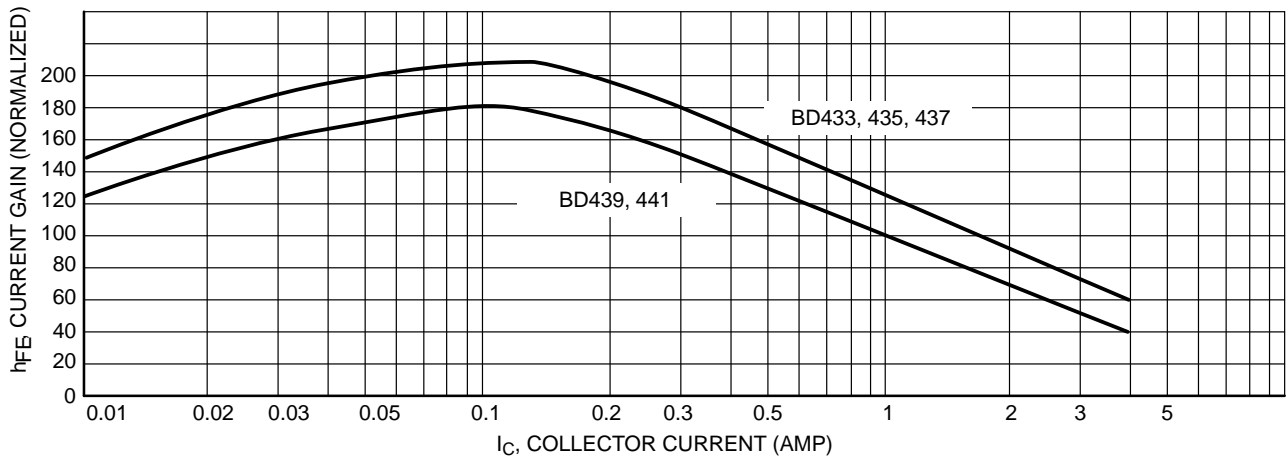

Figure 2. Current Gain

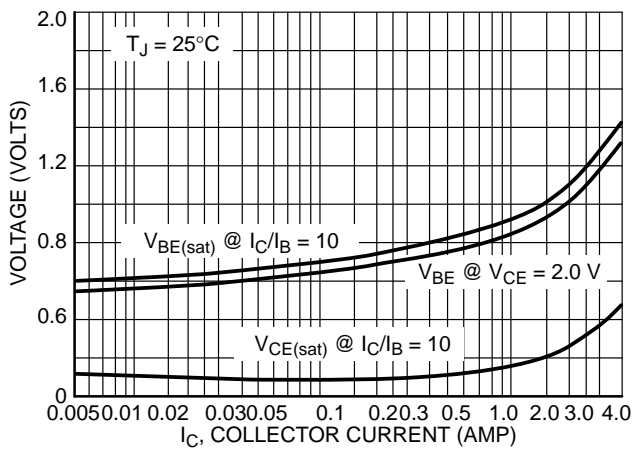

Figure 3. "On" Voltage

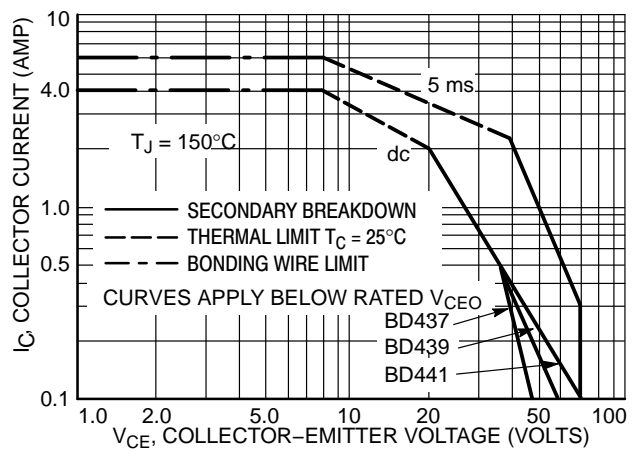
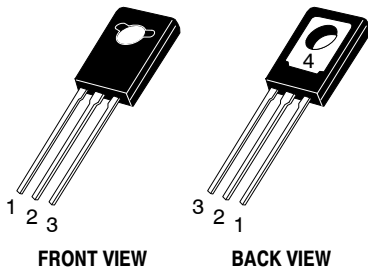

Figure 4. Active Region Safe Operating Area

# MECHANICAL CASE OUTLINE

## PACKAGE DIMENSIONS

ON Semiconductor®



**TO-225**  
CASE 77-09  
ISSUE AD

DATE 25 MAR 2015

SCALE 1:1

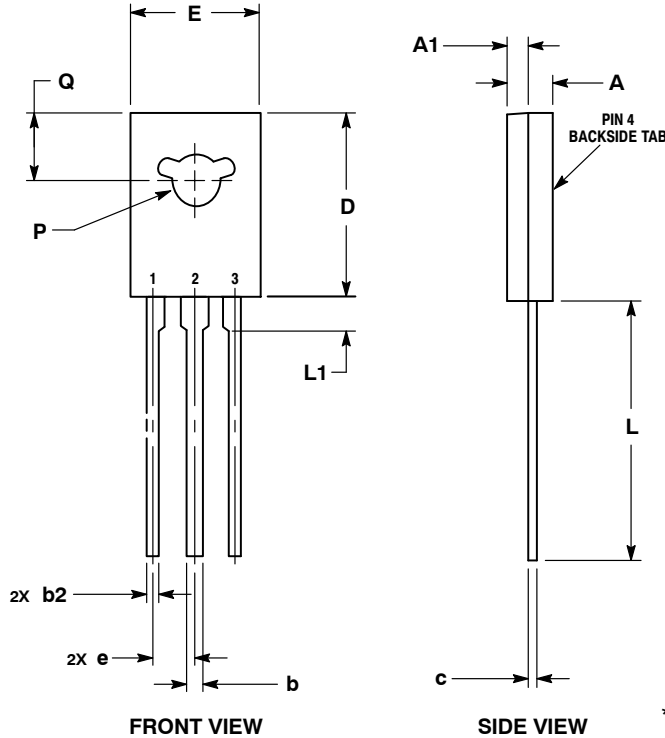

**NOTES:**

1. DIMENSIONING AND TOLERANCING PER ASME Y14.5M, 1994.
2. CONTROLLING DIMENSION: MILLIMETERS.
3. NUMBER AND SHAPE OF LUGS OPTIONAL.

DIM	MILLIMETERS	
	MIN	MAX
A	2.40	3.00
A1	1.00	1.50
b	0.60	0.90
b2	0.51	0.88
c	0.39	0.63
D	10.60	11.10
E	7.40	7.80
e	2.04	2.54
L	14.50	16.63
L1	1.27	2.54
P	2.90	3.30
Q	3.80	4.20

**GENERIC MARKING DIAGRAM\***

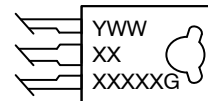

- Y = Year
- WW = Work Week
- XXXXX = Device Code
- G = Pb-Free Package

\*This information is generic. Please refer to device data sheet for actual part marking. Pb-Free indicator, "G" or microdot "µ", may or may not be present.

- |   |   |   |   |   |
|---|---|---|---|---|
| <p>STYLE 1:<br/>PIN 1. EMITTER<br/>2., 4. COLLECTOR<br/>3. BASE</p> | <p>STYLE 2:<br/>PIN 1. CATHODE<br/>2., 4. ANODE<br/>3. GATE</p> | <p>STYLE 3:<br/>PIN 1. BASE<br/>2., 4. COLLECTOR<br/>3. EMITTER</p> | <p>STYLE 4:<br/>PIN 1. ANODE 1<br/>2., 4. ANODE 2<br/>3. GATE</p> | <p>STYLE 5:<br/>PIN 1. MT 1<br/>2., 4. MT 2<br/>3. GATE</p>     |
| <p>STYLE 6:<br/>PIN 1. CATHODE<br/>2., 4. GATE<br/>3. ANODE</p>     | <p>STYLE 7:<br/>PIN 1. MT 1<br/>2., 4. GATE<br/>3. MT 2</p>     | <p>STYLE 8:<br/>PIN 1. SOURCE<br/>2., 4. GATE<br/>3. DRAIN</p>      | <p>STYLE 9:<br/>PIN 1. GATE<br/>2., 4. DRAIN<br/>3. SOURCE</p>    | <p>STYLE 10:<br/>PIN 1. SOURCE<br/>2., 4. DRAIN<br/>3. GATE</p> |

<b>DOCUMENT NUMBER:</b>	<b>98ASB42049B</b>	Electronic versions are uncontrolled except when accessed directly from the Document Repository. Printed versions are uncontrolled except when stamped "CONTROLLED COPY" in red.
<b>DESCRIPTION:</b>	<b>TO-225</b>	<b>PAGE 1 OF 1</b>

ON Semiconductor and are trademarks of Semiconductor Components Industries, LLC dba ON Semiconductor or its subsidiaries in the United States and/or other countries. ON Semiconductor reserves the right to make changes without further notice to any products herein. ON Semiconductor makes no warranty, representation or guarantee regarding the suitability of its products for any particular purpose, nor does ON Semiconductor assume any liability arising out of the application or use of any product or circuit, and specifically disclaims any and all liability, including without limitation special, consequential or incidental damages. ON Semiconductor does not convey any license under its patent rights nor the rights of others.

ON Semiconductor and  are trademarks of Semiconductor Components Industries, LLC dba ON Semiconductor or its subsidiaries in the United States and/or other countries. ON Semiconductor owns the rights to a number of patents, trademarks, copyrights, trade secrets, and other intellectual property. A listing of ON Semiconductor's product/patent coverage may be accessed at [www.onsemi.com/site/pdf/Patent-Marking.pdf](http://www.onsemi.com/site/pdf/Patent-Marking.pdf). ON Semiconductor reserves the right to make changes without further notice to any products herein. ON Semiconductor makes no warranty, representation or guarantee regarding the suitability of its products for any particular purpose, nor does ON Semiconductor assume any liability arising out of the application or use of any product or circuit, and specifically disclaims any and all liability, including without limitation special, consequential or incidental damages. Buyer is responsible for its products and applications using ON Semiconductor products, including compliance with all laws, regulations and safety requirements or standards, regardless of any support or applications information provided by ON Semiconductor. "Typical" parameters which may be provided in ON Semiconductor data sheets and/or specifications can and do vary in different applications and actual performance may vary over time. All operating parameters, including "Typicals" must be validated for each customer application by customer's technical experts. ON Semiconductor does not convey any license under its patent rights nor the rights of others. ON Semiconductor products are not designed, intended, or authorized for use as a critical component in life support systems or any FDA Class 3 medical devices or medical devices with a same or similar classification in a foreign jurisdiction or any devices intended for implantation in the human body. Should Buyer purchase or use ON Semiconductor products for any such unintended or unauthorized application, Buyer shall indemnify and hold ON Semiconductor and its officers, employees, subsidiaries, affiliates, and distributors harmless against all claims, costs, damages, and expenses, and reasonable attorney fees arising out of, directly or indirectly, any claim of personal injury or death associated with such unintended or unauthorized use, even if such claim alleges that ON Semiconductor was negligent regarding the design or manufacture of the part. ON Semiconductor is an Equal Opportunity/Affirmative Action Employer. This literature is subject to all applicable copyright laws and is not for resale in any manner.

## PUBLICATION ORDERING INFORMATION

### LITERATURE FULFILLMENT:

Email Requests to: [orderlit@onsemi.com](mailto:orderlit@onsemi.com)

ON Semiconductor Website: [www.onsemi.com](http://www.onsemi.com)

### TECHNICAL SUPPORT

North American Technical Support:  
Voice Mail: 1 800-282-9855 Toll Free USA/Canada  
Phone: 011 421 33 790 2910

### Europe, Middle East and Africa Technical Support:

Phone: 00421 33 790 2910

For additional information, please contact your local Sales Representative

