

Features

- High current density per square mm

Applications

- Overvoltage crowbar protection
- Motor control circuits in power tools and kitchen aids
- Inrush current limiting circuits

Description

This device is mounted in DPAK and intended for use in applications such as voltage regulators circuits for motorbikes, overvoltage crowbar protection, motor control circuits in power tools and capacitive discharge ignition.

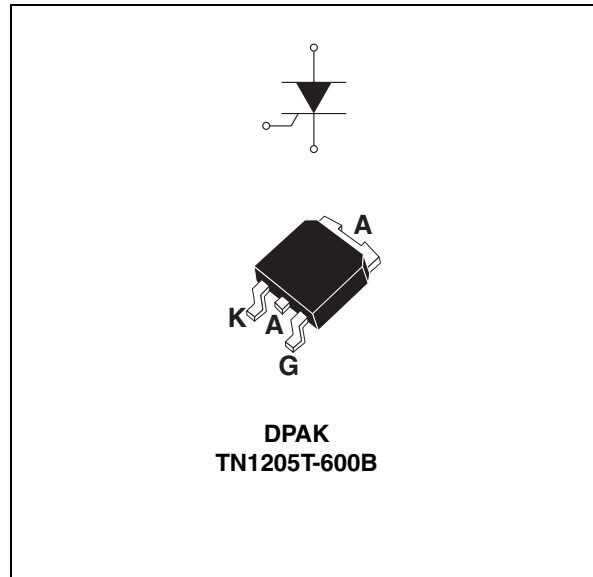

Table 1. Device summary

$I_{T(rms)}$	12 A
V_{DRM}/V_{RRM}	600 V
I_{GT}	2 to 5 mA

1 Characteristics

Table 2. Absolute ratings⁽¹⁾

Symbol	Parameter		Value	Unit	
$I_{T(RMS)}$	On-state rms current (180 °C conduction angle)		$T_c = 103\text{ °C}$	12	A
$I_{T(AV)}$	Average on-state current(180 °C conduction angle)		$T_c = 103\text{ °C}$	8	A
I_{TSM}	Non repetitive surge peak on-state current		$t_p = 8.3\text{ ms}$ $t_p = 10\text{ ms}$	120 115	A
I^2T	I^2T value for fusing		$t_p = 10\text{ ms}$	66	A ² s
di/dt	Critical rate of rise of on-state current $I_G = 2 \times I_{GT}$, $tr \leq 100\text{ ns}$	$F = 60\text{ Hz}$	$T_j = 125\text{ °C}$	50	A/ μ s
I_{GM}	Peak gate current	$t_p = 20\text{ }\mu$ s	$T_c = 125\text{ °C}$	4	A
$P_{G(AV)}$	Average gate power dissipation		$T_j = 125\text{ °C}$	1	W
T_{stg}	Storage junction temperature range			-40 to + 150	°C
T_j	Operating junction temperature range			-40 to + 125	

1. $T_j = 25\text{ °C}$, unless otherwise specified

Table 3. Electrical characteristics⁽¹⁾

Symbol	Test conditions		Min.	Typ.	Max.	Unit
I_{GT}	$V_D = 12\text{ V}$, $R_L = 33\text{ }\Omega$		2		5	mA
V_{GT}	$V_D = 12\text{ V}$, $R_L = 33\text{ }\Omega$				1.3	V
V_{GD}	$V_D = V_{DRM}$, $R_L = 3.3\text{ k}\Omega$	$T_j = 125\text{ °C}$	0.2			V
I_H	$I_T = 500\text{ mA}$ gate open				15	mA
I_L	$I_G = 1.2 I_{GT}$				30	mA
dV/dt	$V_D = 67\% V_{DRM}$ gate open	$T_j = 125\text{ °C}$	100			V/ μ s
t_{GT}	Gate controlled turn on time $I_{TM} = 40\text{ A}$, $V_D = V_{DRM(MAX)}$, $I_{GT} = 100\text{ mA}$ $dl_G/dt = 5\text{ A}/\mu$ s, $R_G = 68\text{ }\Omega$			1.2		μ s
t_q	Circuit commutated turn off time $V_D = 67\% V_{DRM(MAX)}$, $T_j = 125\text{ °C}$, $I_{TM} = 20\text{ A}$, $V_R = 25\text{ V}$ $dl_T/dt = 30\text{ A}/\mu$ S, $dV_D/dt = 50\text{ V}/\mu$ s, $R_{GK} = 100\text{ }\Omega$			55		μ s
V_{TM}	$I_{TM} = 24\text{ A}$, $T_p = 380\text{ }\mu$ s				1.6	V
V_{T0}	Threshold voltage	$T_j = 125\text{ °C}$			0.85	V
R_d	Dynamyc restistance	$T_j = 125\text{ °C}$			30	m Ω
I_{DRM}	$V_{DRM} = V_{RRM}$	$T_j = 25\text{ °C}$			5	μ A
I_{RRM}		$T_j = 125\text{ °C}$			2	mA

1. $T_j = 25\text{ °C}$, unless otherwise specified

Table 4. Thermal resistance

Symbol	Parameter	Value	Unit
$R_{th(j-c)}$	Junction to case (DC)	1.8	$^{\circ}C/W$
$R_{th(j-a)}$	Junction to ambient (DC)	$S^{(1)} = 0.5 \text{ cm}^2$	$^{\circ}C/W$

1. S = Copper surface under tab.

Figure 1. Maximum average power dissipation versus average on-state current

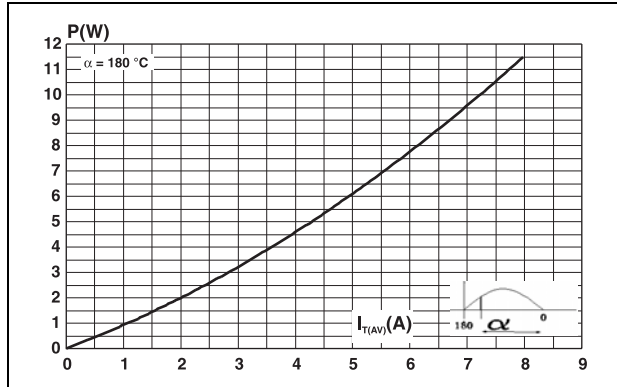

Figure 2. Average and DC on-state current versus case temperature

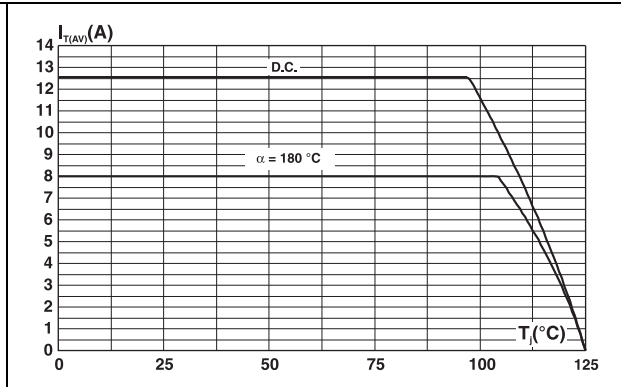

Figure 3. Average DC on-state current versus ambient temperature

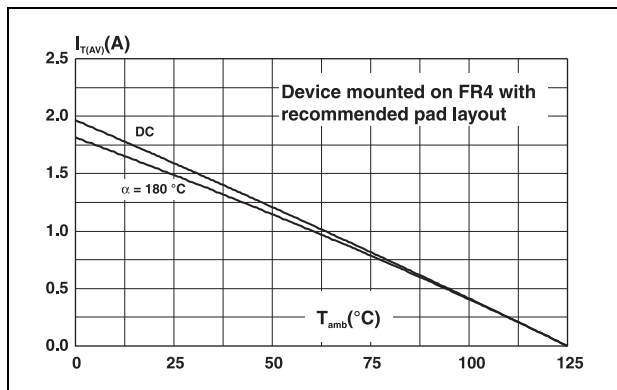

Figure 4. Relative variation of thermal impedance junction to case versus pulse duration

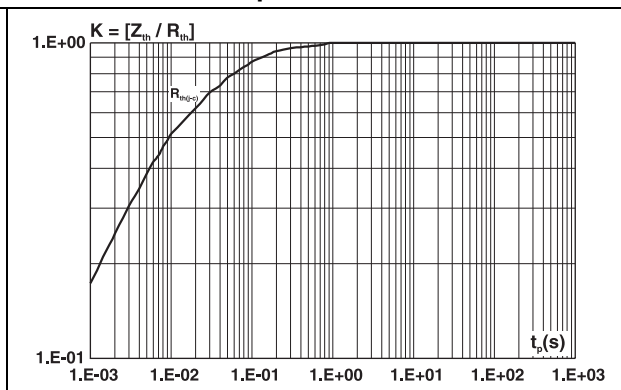

Figure 5. Relative variation of thermal impedance junction to ambient versus pulse duration

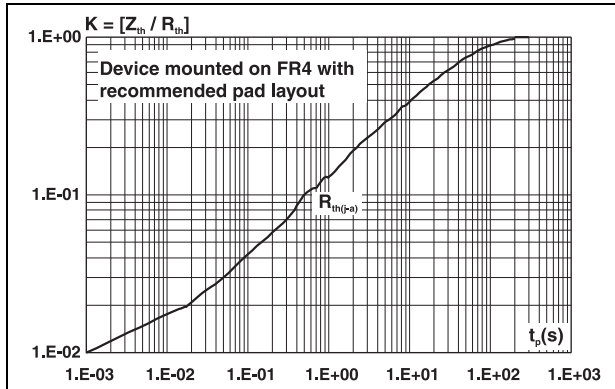

Figure 6. Relative variation of gate trigger current and voltage, holding and latching current versus Tj

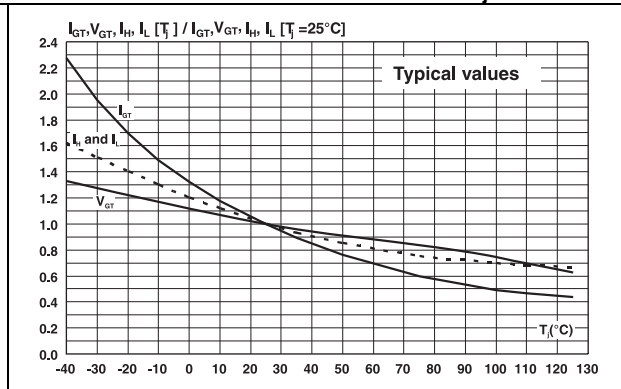

Figure 7. Surge peak on-state current versus number of cycles

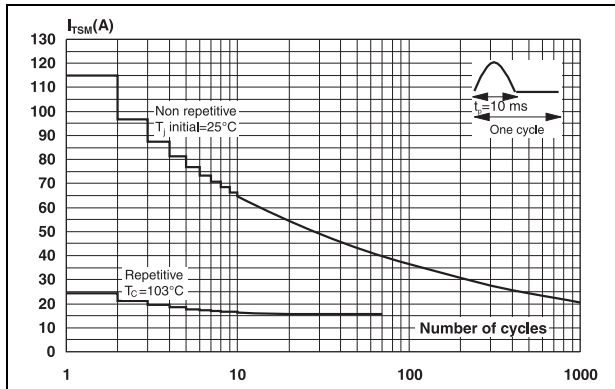

Figure 8. Non-repetitive surge peak on-state current for a sinusoidal pulse, and corresponding values of I²t

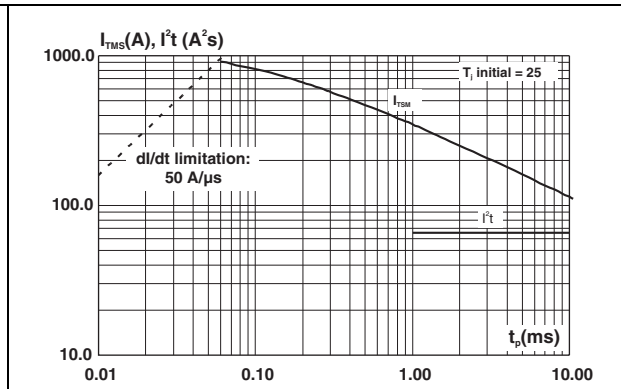

Figure 9. On-state characteristics (maximum values)

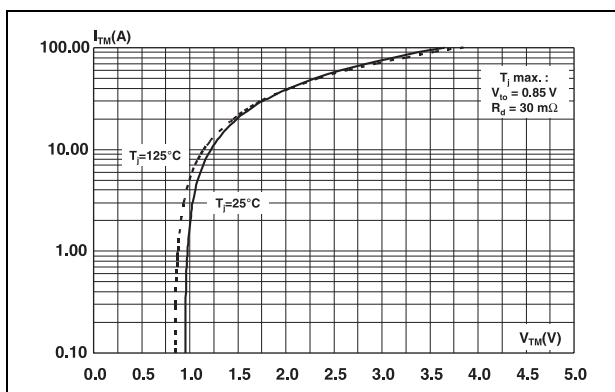
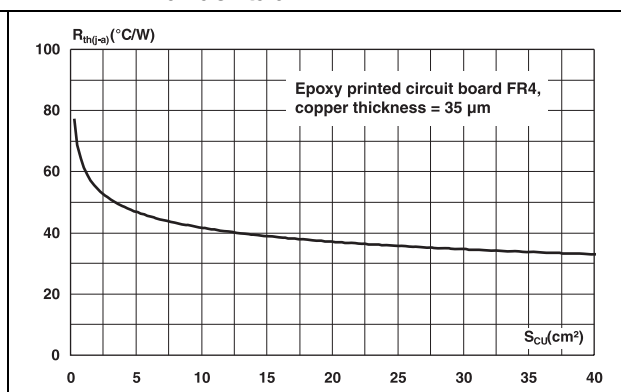
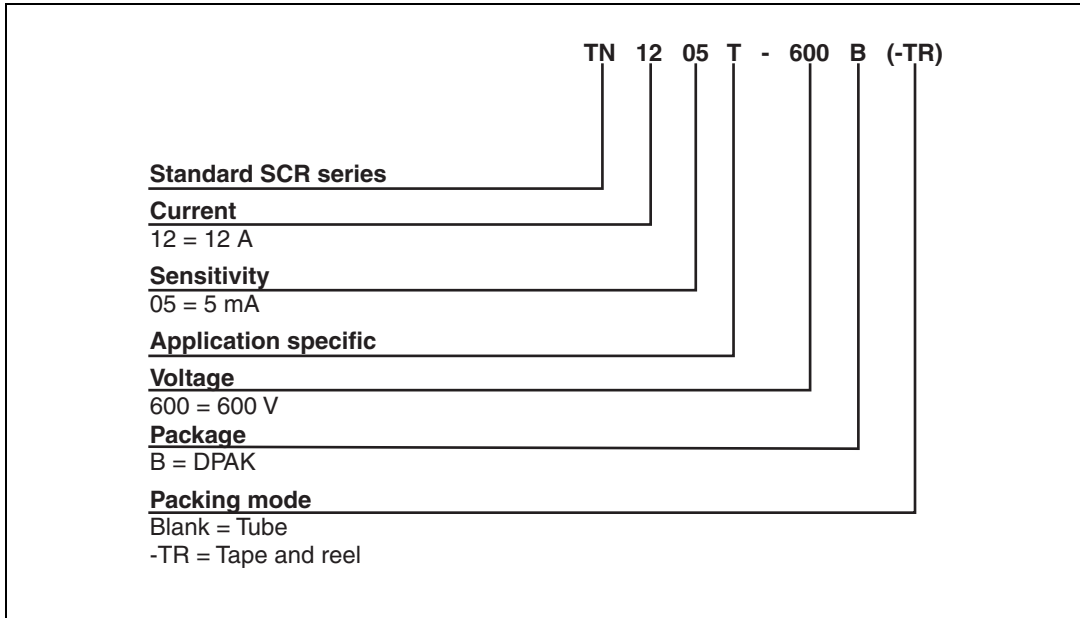

Figure 10. Thermal resistance junction to ambient versus copper surface under tab



2 Ordering information scheme

Figure 11. Ordering information scheme



3 Package information

- Epoxy meets UL94, V0
- Lead-free package

In order to meet environmental requirements, ST offers these devices in different grades of ECOPACK® packages, depending on their level of environmental compliance. ECOPACK® specifications, grade definitions and product status are available at: www.st.com. ECOPACK® is an ST trademark.

Table 5. DPAK dimensions

Ref.	Dimensions			
	Millimeters		Inches	
	Min.	Max.	Min.	Max.
A	2.20	2.40	0.086	0.094
A1	0.90	1.10	0.035	0.043
A2	0.03	0.23	0.001	0.009
B	0.64	0.90	0.025	0.035
B2	5.20	5.40	0.204	0.212
C	0.45	0.60	0.017	0.023
C2	0.48	0.60	0.018	0.023
D	6.00	6.20	0.236	0.244
E	6.40	6.60	0.251	0.259
G	4.40	4.60	0.173	0.181
H	9.35	10.10	0.368	0.397
L2	0.80 typ.		0.031 typ.	
L4	0.60	1.00	0.023	0.039
V2	0°	8°	0°	8°

Figure 12. Footprint (dimensions in mm)

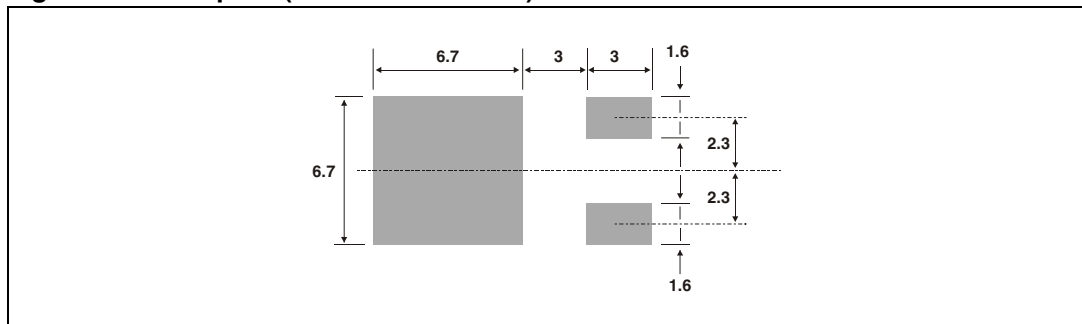

4 Ordering information

Table 6. Ordering information

Order code	Marking	Package	Weight	Base qty	Delivery mode
TN1205T-600B	TN12 05T6	DPAK	0.3g	75	Tube
TN1205T-600B-TR	TN12 05T6			2500	Tape and reel

5 Revision history

Table 7. Document revision history

Date	Revision	Changes
01-Oct-2009	1	Initial release.

Please Read Carefully:

Information in this document is provided solely in connection with ST products. STMicroelectronics NV and its subsidiaries ("ST") reserve the right to make changes, corrections, modifications or improvements, to this document, and the products and services described herein at any time, without notice.

All ST products are sold pursuant to ST's terms and conditions of sale.

Purchasers are solely responsible for the choice, selection and use of the ST products and services described herein, and ST assumes no liability whatsoever relating to the choice, selection or use of the ST products and services described herein.

No license, express or implied, by estoppel or otherwise, to any intellectual property rights is granted under this document. If any part of this document refers to any third party products or services it shall not be deemed a license grant by ST for the use of such third party products or services, or any intellectual property contained therein or considered as a warranty covering the use in any manner whatsoever of such third party products or services or any intellectual property contained therein.

UNLESS OTHERWISE SET FORTH IN ST'S TERMS AND CONDITIONS OF SALE ST DISCLAIMS ANY EXPRESS OR IMPLIED WARRANTY WITH RESPECT TO THE USE AND/OR SALE OF ST PRODUCTS INCLUDING WITHOUT LIMITATION IMPLIED WARRANTIES OF MERCHANTABILITY, FITNESS FOR A PARTICULAR PURPOSE (AND THEIR EQUIVALENTS UNDER THE LAWS OF ANY JURISDICTION), OR INFRINGEMENT OF ANY PATENT, COPYRIGHT OR OTHER INTELLECTUAL PROPERTY RIGHT.

UNLESS EXPRESSLY APPROVED IN WRITING BY AN AUTHORIZED ST REPRESENTATIVE, ST PRODUCTS ARE NOT RECOMMENDED, AUTHORIZED OR WARRANTED FOR USE IN MILITARY, AIR CRAFT, SPACE, LIFE SAVING, OR LIFE SUSTAINING APPLICATIONS, NOR IN PRODUCTS OR SYSTEMS WHERE FAILURE OR MALFUNCTION MAY RESULT IN PERSONAL INJURY, DEATH, OR SEVERE PROPERTY OR ENVIRONMENTAL DAMAGE. ST PRODUCTS WHICH ARE NOT SPECIFIED AS "AUTOMOTIVE GRADE" MAY ONLY BE USED IN AUTOMOTIVE APPLICATIONS AT USER'S OWN RISK.

Resale of ST products with provisions different from the statements and/or technical features set forth in this document shall immediately void any warranty granted by ST for the ST product or service described herein and shall not create or extend in any manner whatsoever, any liability of ST.

ST and the ST logo are trademarks or registered trademarks of ST in various countries.

Information in this document supersedes and replaces all information previously supplied.

The ST logo is a registered trademark of STMicroelectronics. All other names are the property of their respective owners.

© 2009 STMicroelectronics - All rights reserved

STMicroelectronics group of companies

Australia - Belgium - Brazil - Canada - China - Czech Republic - Finland - France - Germany - Hong Kong - India - Israel - Italy - Japan - Malaysia - Malta - Morocco - Philippines - Singapore - Spain - Sweden - Switzerland - United Kingdom - United States of America

www.st.com