

N-channel 900 V, 0.72 Ω typ., 7 A, MDmesh™ K5 Power MOSFET in a TO-220FP package

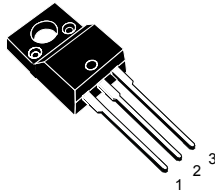

TO-220FP

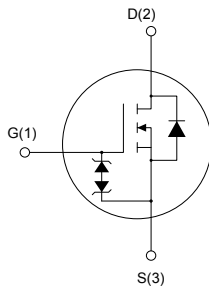

AM01476v1_No_tab

Features

Order code	V_{DS}	$R_{DS(on)}$ max.	I_D
STF7N90K5	900 V	0.81 Ω	7 A

- Industry's lowest $R_{DS(on)}$ x area
- Industry's best FoM (figure of merit)
- Ultra-low gate charge
- 100% avalanche tested
- Zener-protected

Applications

- Switching applications

Description

This very high voltage N-channel Power MOSFET is designed using MDmesh™ K5 technology based on an innovative proprietary vertical structure. The result is a dramatic reduction in on-resistance and ultra-low gate charge for applications requiring superior power density and high efficiency.

Product status

STF7N90K5

Product summary

Order code	STF7N90K5
Marking	7N90K5
Package	TO-220FP
Packing	Tube

1 Electrical ratings

Table 1. Absolute maximum ratings

Symbol	Parameter	Value	Unit
V_{GS}	Gate-source voltage	±30	V
I_D	Drain current (continuous) at $T_C = 25\text{ °C}$	7	A
I_D	Drain current (continuous) at $T_C = 100\text{ °C}$	4.4	A
$I_D^{(1)}$	Drain current (pulsed)	28	A
P_{TOT}	Total dissipation at $T_C = 25\text{ °C}$	25	W
V_{ISO}	Insulation withstand voltage (RMS) from all three leads to external heat sink ($t = 1\text{ s}$, $T_C = 25\text{ °C}$)	2500	V
$dv/dt^{(2)}$	Peak diode recovery voltage slope	4.5	V/ns
$dv/dt^{(3)}$	MOSFET dv/dt ruggedness	50	
T_j	Operating junction temperature range	-55 to 150	°C
T_{stg}	Storage temperature range		

1. Pulse width limited by safe operating area
2. $I_{SD} \leq 7\text{ A}$, $di/dt \leq 100\text{ A}/\mu\text{s}$, $V_{DS\text{ peak}} < V_{(BR)DSS}$, $V_{DD} = 450\text{ V}$
3. $V_{DS} \leq 720\text{ V}$

Table 2. Thermal data

Symbol	Parameter	Value	Unit
$R_{thj-case}$	Thermal resistance junction-case	5	°C/W
$R_{thj-amb}$	Thermal resistance junction-ambient	62.5	°C/W

Table 3. Avalanche characteristics

Symbol	Parameter	Value	Unit
I_{AR}	Avalanche current, repetitive or not repetitive (pulse width limited by T_{jmax})	2.4	A
E_{AS}	Single pulse avalanche energy (starting $T_j = 25\text{ °C}$, $I_D = I_{AR}$, $V_{DD} = 50\text{ V}$)	230	mJ

2 Electrical characteristics

$T_C = 25\text{ °C}$ unless otherwise specified

Table 4. On-/off-state

Symbol	Parameter	Test conditions	Min.	Typ.	Max.	Unit
$V_{(BR)DSS}$	Drain-source breakdown voltage	$V_{GS} = 0\text{ V}$, $I_D = 1\text{ mA}$	900			V
I_{DSS}	Zero gate voltage drain current	$V_{GS} = 0\text{ V}$, $V_{DS} = 900\text{ V}$			1	μA
		$V_{GS} = 0\text{ V}$, $V_{DS} = 900\text{ V}$ $T_C = 125\text{ °C}$ ⁽¹⁾			50	μA
I_{GSS}	Gate body leakage current	$V_{DS} = 0\text{ V}$, $V_{GS} = \pm 20\text{ V}$			± 10	μA
$V_{GS(th)}$	Gate threshold voltage	$V_{DD} = V_{GS}$, $I_D = 100\text{ }\mu\text{A}$	3	4	5	V
$R_{DS(on)}$	Static drain-source on-resistance	$V_{GS} = 10\text{ V}$, $I_D = 3.5\text{ A}$		0.72	0.81	Ω

1. Defined by design, not subject to production test.

Table 5. Dynamic

Symbol	Parameter	Test conditions	Min.	Typ.	Max.	Unit
C_{iss}	Input capacitance	$V_{DS} = 100\text{ V}$, $f = 1\text{ MHz}$, $V_{GS} = 0\text{ V}$	-	425	-	pF
C_{oss}	Output capacitance		-	41	-	pF
C_{rss}	Reverse transfer capacitance		-	1.2	-	pF
$C_{o(tr)}^{(1)}$	Time-related equivalent capacitance	$V_{GS} = 0$, $V_{DS} = 0\text{ to }720\text{ V}$	-	64	-	pF
$C_{o(er)}^{(2)}$	Energy-related equivalent capacitance		-	24	-	pF
R_g	Intrinsic gate resistance	$f = 1\text{ MHz}$, $I_D = 0\text{ A}$	-	6.7	-	Ω
Q_g	Total gate charge	$V_{DD} = 720\text{ V}$, $I_D = 7\text{ A}$	-	12	-	nC
Q_{gs}	Gate-source charge	$V_{GS} = 0\text{ to }10\text{ V}$	-	3.5	-	nC
Q_{gd}	Gate-drain charge	(see Figure 14. Test circuit for gate charge behavior)	-	6.5	-	nC

1. $C_{o(tr)}$ is a constant capacitance value that gives the same charging time as C_{oss} while V_{DS} is rising from 0 to 80% V_{DSS} .

2. $C_{o(er)}$ is a constant capacitance value that gives the same stored energy as C_{oss} while V_{DS} is rising from 0 to 80% V_{DSS} .

Table 6. Switching times

Symbol	Parameter	Test conditions	Min.	Typ.	Max.	Unit
$t_{d(on)}$	Turn-on delay time	$V_{DD} = 450\text{ V}$, $I_D = 3.5\text{ A}$, $R_G = 4.7\text{ }\Omega$, $V_{GS} = 10\text{ V}$	-	13.2	-	ns
t_r	Rise time		-	14.2	-	ns
$t_{d(off)}$	Turn-off delay time	(see Figure 13. Test circuit for resistive load switching times and Figure 18. Switching time waveform)	-	31.6	-	ns
t_f	Fall time		-	14.7	-	ns

Table 7. Source-drain diode

Symbol	Parameter	Test conditions	Min.	Typ.	Max.	Unit
I_{SD}	Source-drain current		-		7	A
$I_{SDM}^{(1)}$	Source-drain current (pulsed)		-		28	A
$V_{SD}^{(2)}$	Forward on voltage	$I_{SD} = 7\text{ A}$, $V_{GS} = 0\text{ V}$	-		1.5	V
t_{rr}	Reverse recovery time	$I_{SD} = 7\text{ A}$, $di/dt = 100\text{ A}/\mu\text{s}$, $V_{DD} = 60\text{ V}$	-	352		ns
Q_{rr}	Reverse recovery charge		-	3.63		μC
I_{RRM}	Reverse recovery current	(see Figure 15. Test circuit for inductive load switching and diode recovery times)	-	20.6		A
t_{rr}	Reverse recovery time	$I_{SD} = 7\text{ A}$, $di/dt = 100\text{ A}/\mu\text{s}$, $V_{DD} = 60\text{ V}$, $T_j = 150\text{ }^\circ\text{C}$	-	525		ns
Q_{rr}	Reverse recovery charge		-	4.94		μC
I_{RRM}	Reverse recovery current		(see Figure 15. Test circuit for inductive load switching and diode recovery times)	-	18.8	

1. Pulse width limited by safe operating area
2. Pulsed: pulse duration = 300 μs , duty cycle 1.5%

Table 8. Gate-source Zener diode

Symbol	Parameter	Test conditions	Min.	Typ.	Max.	Unit
$V_{(BR)GSO}$	Gate-source breakdown voltage	$I_{GS} = \pm 1\text{ mA}$, $I_D = 0\text{ A}$	± 30	-	-	V

The built-in back-to-back Zener diodes are specifically designed to enhance the ESD performance of the device. The Zener voltage facilitates efficient and cost-effective device integrity protection, thus eliminating the need for additional external componentry.

2.1 Electrical characteristics (curves)

Figure 1. Safe operating area

Figure 2. Thermal impedance

Figure 3. Output characteristics

Figure 4. Transfer characteristics

Figure 5. Gate charge vs gate-source voltage

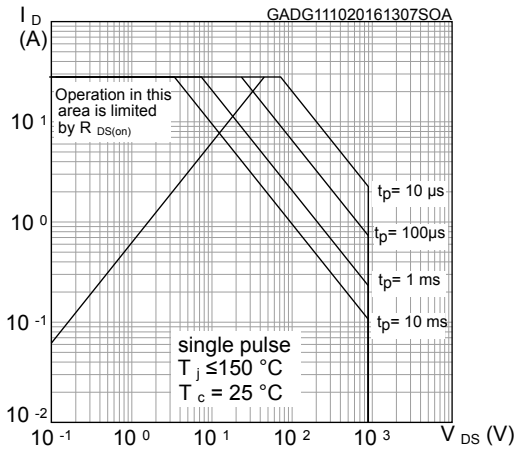
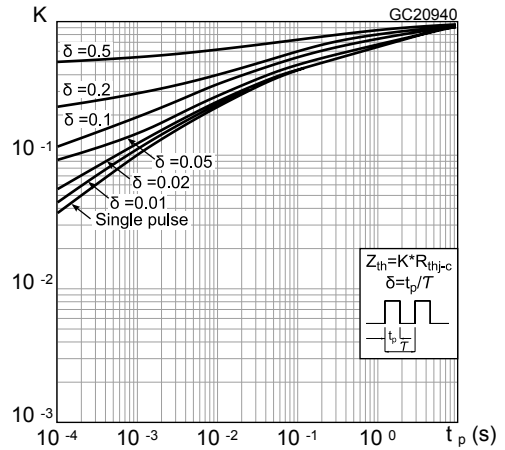
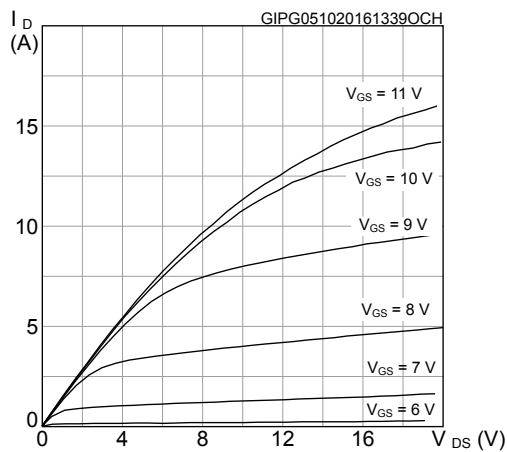
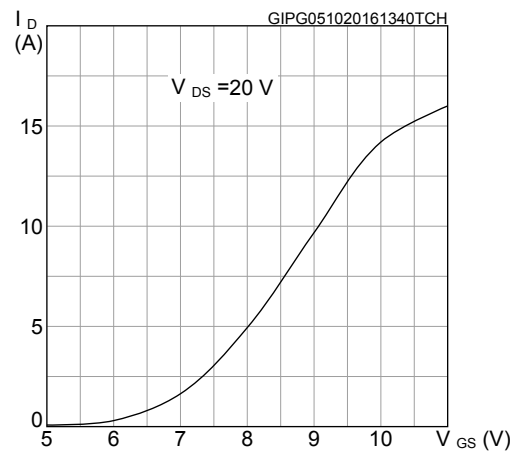
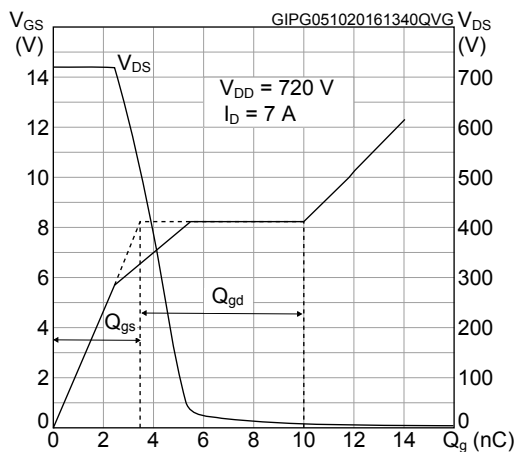
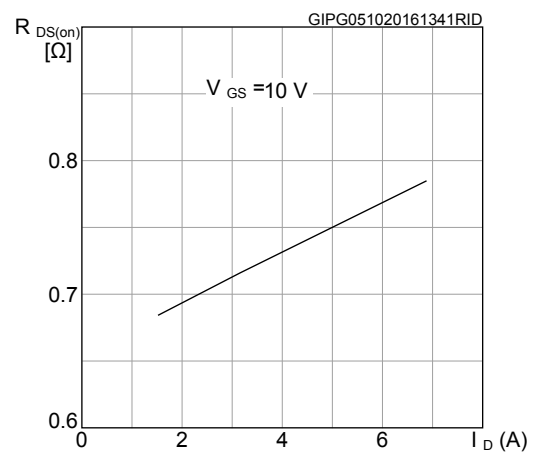
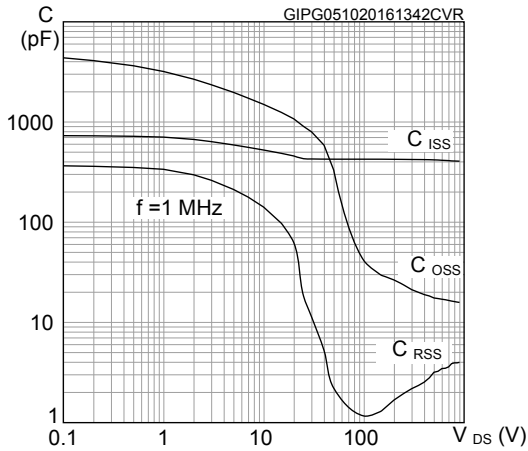
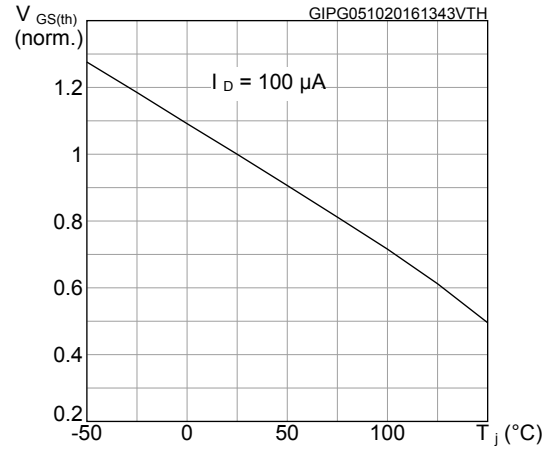
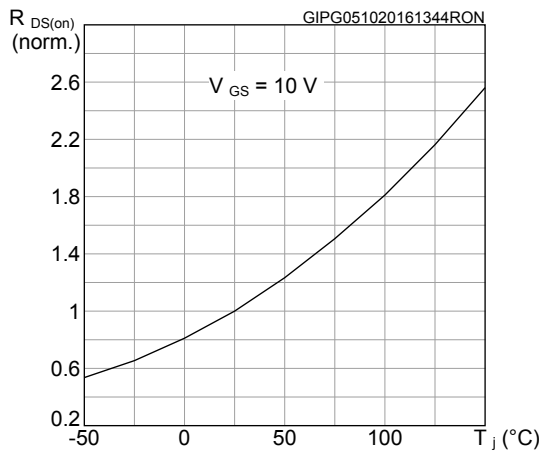
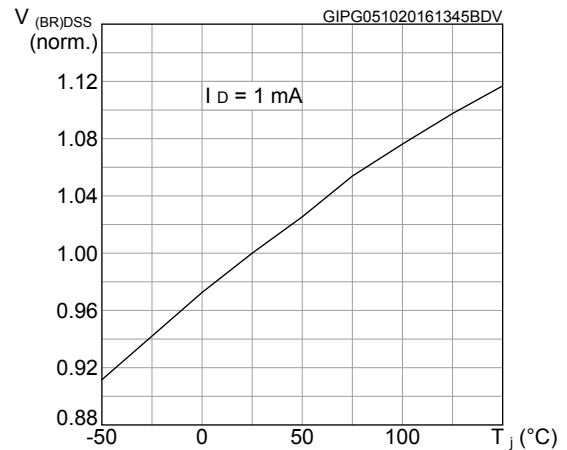
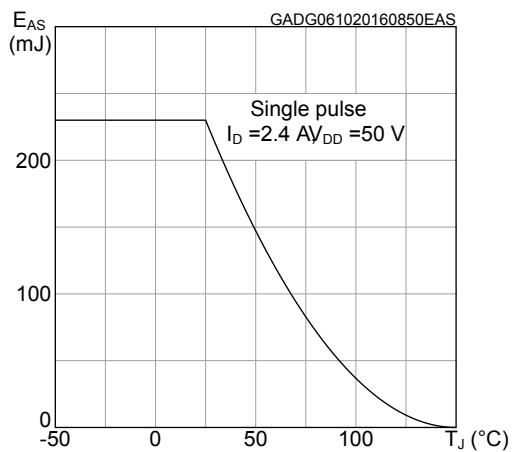
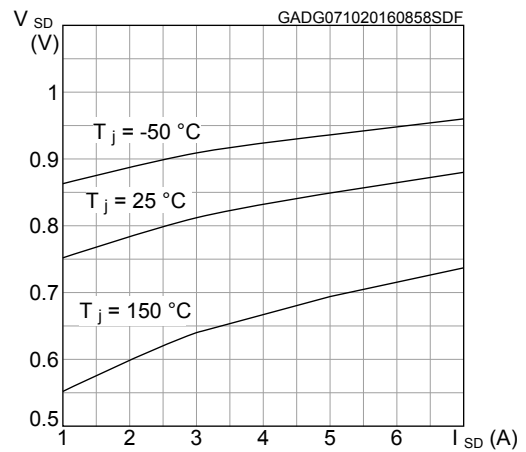
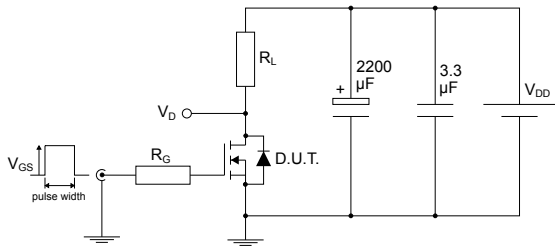
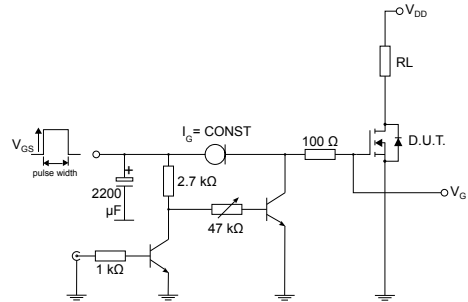
Figure 6. Static drain-source on-resistance

Figure 7. Capacitance variations

Figure 8. Normalized gate threshold voltage vs temperature

Figure 9. Normalized on-resistance vs temperature

Figure 10. Normalized $V_{(BR)DSS}$ vs temperature

Figure 11. Maximum avalanche energy vs starting T_j

Figure 12. Source-drain diode forward characteristics

3 Test circuits

Figure 13. Test circuit for resistive load switching times

AM01468v1

Figure 14. Test circuit for gate charge behavior

AM01469v10

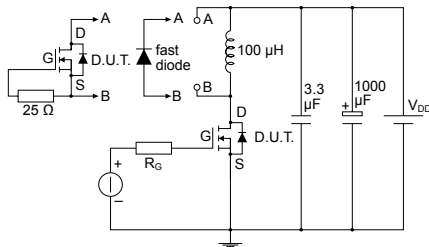
Figure 15. Test circuit for inductive load switching and diode recovery times

AM01470v1

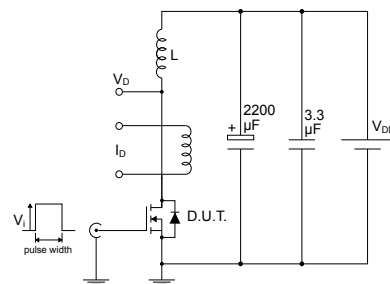
Figure 16. Unclamped inductive load test circuit

AM01471v1

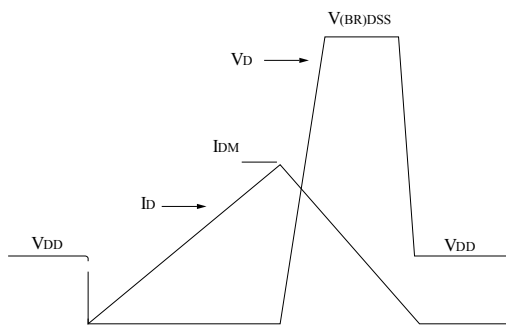
Figure 17. Unclamped inductive waveform

AM01472v1

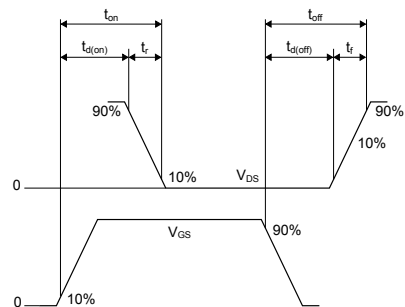
Figure 18. Switching time waveform

AM01473v1

4 Package information

In order to meet environmental requirements, ST offers these devices in different grades of ECOPACK® packages, depending on their level of environmental compliance. ECOPACK® specifications, grade definitions and product status are available at: www.st.com. ECOPACK® is an ST trademark.

4.1 TO-220FP package information

Figure 19. TO-220FP package outline

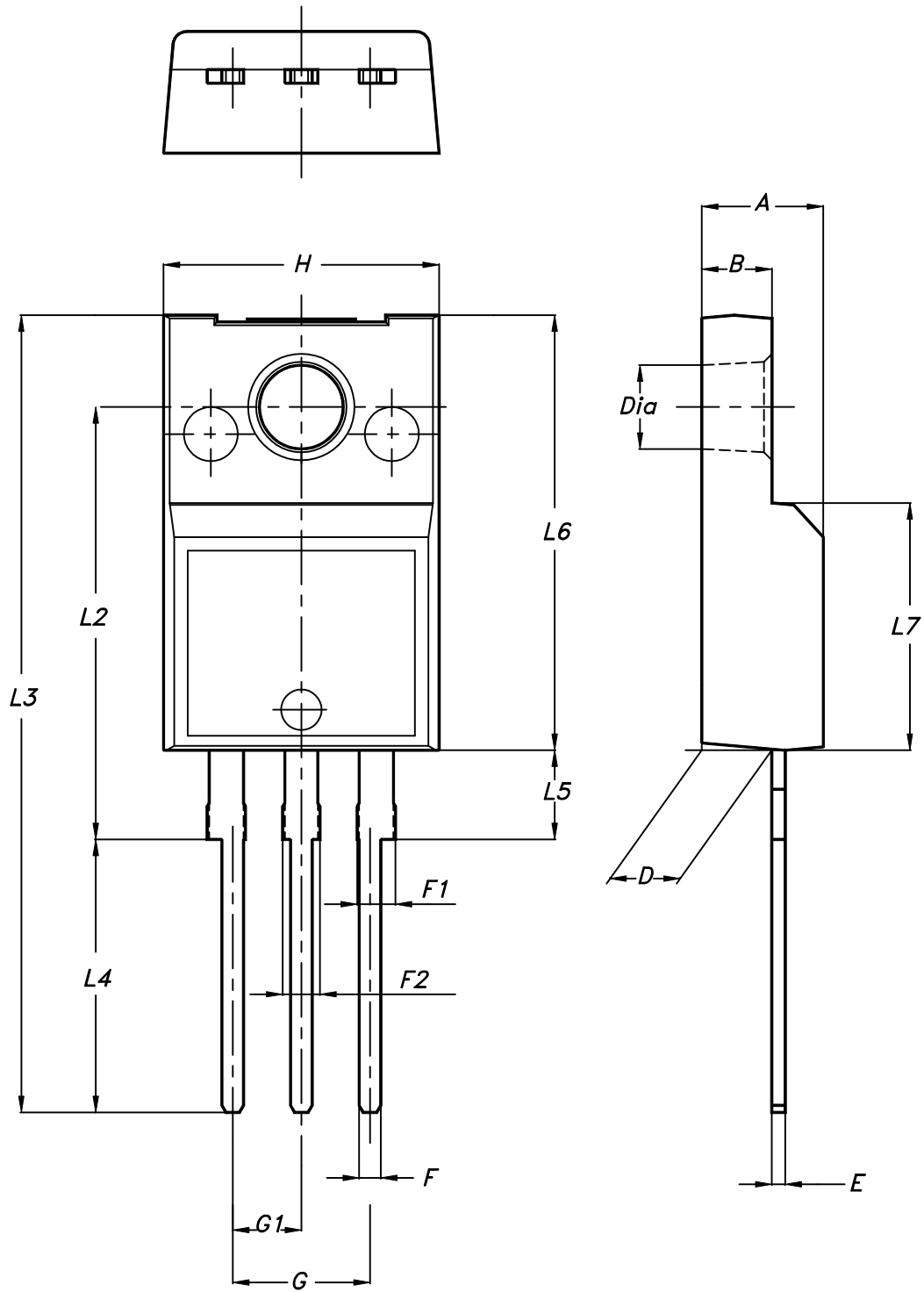

7012510_Rev_12_B

Table 9. TO-220FP package mechanical data

Dim.	mm		
	Min.	Typ.	Max.
A	4.4		4.6
B	2.5		2.7
D	2.5		2.75
E	0.45		0.7
F	0.75		1
F1	1.15		1.70
F2	1.15		1.70
G	4.95		5.2
G1	2.4		2.7
H	10		10.4
L2		16	
L3	28.6		30.6
L4	9.8		10.6
L5	2.9		3.6
L6	15.9		16.4
L7	9		9.3
Dia	3		3.2

Revision history

Table 10. Document revision history

Date	Revision	Changes
11-Oct-2016	1	First release.
21-Feb-2018	2	Removed maturity status indication from cover page. The document status is production data. Updated Table 5. Dynamic . Updated Figure 5. Gate charge vs gate-source voltage . Updated Section 4.1 TO-220FP package information . Minor text changes

Contents

1	Electrical ratings	2
2	Electrical characteristics	3
2.1	Electrical characteristics (curves)	5
3	Test circuits	7
4	Package information	8
4.1	TO-220FP package information	8
	Revision history	11
	Contents	12
	Disclaimer	13

IMPORTANT NOTICE – PLEASE READ CAREFULLY

STMicroelectronics NV and its subsidiaries (“ST”) reserve the right to make changes, corrections, enhancements, modifications, and improvements to ST products and/or to this document at any time without notice. Purchasers should obtain the latest relevant information on ST products before placing orders. ST products are sold pursuant to ST’s terms and conditions of sale in place at the time of order acknowledgement.

Purchasers are solely responsible for the choice, selection, and use of ST products and ST assumes no liability for application assistance or the design of Purchasers’ products.

No license, express or implied, to any intellectual property right is granted by ST herein.

Resale of ST products with provisions different from the information set forth herein shall void any warranty granted by ST for such product.

ST and the ST logo are trademarks of ST. All other product or service names are the property of their respective owners.

Information in this document supersedes and replaces information previously supplied in any prior versions of this document.

© 2018 STMicroelectronics – All rights reserved