

# ON Semiconductor

## Is Now

# onsemi™

To learn more about onsemi™, please visit our website at  
[www.onsemi.com](http://www.onsemi.com)

**onsemi** and **onsemi** and other names, marks, and brands are registered and/or common law trademarks of Semiconductor Components Industries, LLC dba "**onsemi**" or its affiliates and/or subsidiaries in the United States and/or other countries. **onsemi** owns the rights to a number of patents, trademarks, copyrights, trade secrets, and other intellectual property. A listing of **onsemi** product/patent coverage may be accessed at [www.onsemi.com/site/pdf/Patent-Marking.pdf](http://www.onsemi.com/site/pdf/Patent-Marking.pdf). **onsemi** reserves the right to make changes at any time to any products or information herein, without notice. The information herein is provided "as-is" and **onsemi** makes no warranty, representation or guarantee regarding the accuracy of the information, product features, availability, functionality, or suitability of its products for any particular purpose, nor does **onsemi** assume any liability arising out of the application or use of any product or circuit, and specifically disclaims any and all liability, including without limitation special, consequential or incidental damages. Buyer is responsible for its products and applications using **onsemi** products, including compliance with all laws, regulations and safety requirements or standards, regardless of any support or applications information provided by **onsemi**. "Typical" parameters which may be provided in **onsemi** data sheets and/or specifications can and do vary in different applications and actual performance may vary over time. All operating parameters, including "Typicals" must be validated for each customer application by customer's technical experts. **onsemi** does not convey any license under any of its intellectual property rights nor the rights of others. **onsemi** products are not designed, intended, or authorized for use as a critical component in life support systems or any FDA Class 3 medical devices or medical devices with a same or similar classification in a foreign jurisdiction or any devices intended for implantation in the human body. Should Buyer purchase or use **onsemi** products for any such unintended or unauthorized application, Buyer shall indemnify and hold **onsemi** and its officers, employees, subsidiaries, affiliates, and distributors harmless against all claims, costs, damages, and expenses, and reasonable attorney fees arising out of, directly or indirectly, any claim of personal injury or death associated with such unintended or unauthorized use, even if such claim alleges that **onsemi** was negligent regarding the design or manufacture of the part. **onsemi** is an Equal Opportunity/Affirmative Action Employer. This literature is subject to all applicable copyright laws and is not for resale in any manner. Other names and brands may be claimed as the property of others.

# NJW44H11G

## 80 V NPN, 10 A Power Transistor

These series of plastic, silicon NPN power transistors can be used as general purpose power amplification and switching such as output or driver stages in applications such as switching regulators, converters and power amplifiers.

### Features

- Fast Switching Speeds
- High Frequency
- These Devices are Pb-Free, Halogen Free/BFR Free and are RoHS Compliant

### Benefits

- Reliable Performance at Higher Powers
- Symmetrical Characteristics in Complementary Configurations
- Accurate Reproduction of Input Signal
- Greater Dynamic Range
- High Amplifier Bandwidth

### Applications

- High-end Consumer Audio Products
  - ◆ Home Amplifiers
  - ◆ Home Receivers

### MAXIMUM RATINGS ( $T_A = 25^\circ\text{C}$ )

Rating	Symbol	Max	Unit
Collector-Emitter Voltage	$V_{CEO}$	80	Vdc
Emitter-Base Voltage	$V_{EBO}$	5.0	Vdc
Collector Current - Continuous	$I_C$	10	A
Collector Current - Peak (Note 1)	$I_{CM}$	20	A
Total Power Dissipation @ $T_C = 25^\circ\text{C}$	$P_D$	120	Watts

### THERMAL CHARACTERISTICS

Characteristic	Symbol	Max	Unit
Thermal Resistance, Junction to Case	$R_{\theta JC}$	1.04	$^\circ\text{C/W}$
Junction and Storage Temperature Range	$T_J, T_{stg}$	-65 to +150	$^\circ\text{C}$

Stresses exceeding Maximum Ratings may damage the device. Maximum Ratings are stress ratings only. Functional operation above the Recommended Operating Conditions is not implied. Extended exposure to stresses above the Recommended Operating Conditions may affect device reliability.

1. Pulse Test: Pulse Width = 5 ms, Duty Cycle  $\leq 10\%$ .

\*For additional information on our Pb-Free strategy and soldering details, please download the ON Semiconductor Soldering and Mounting Techniques Reference Manual, SOLDERRM/D.



ON Semiconductor®

<http://onsemi.com>

## 80 VOLT, 10 AMPS NPN POWER TRANSISTORS

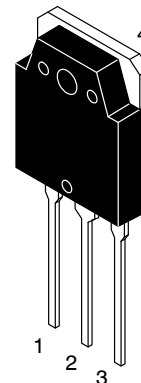
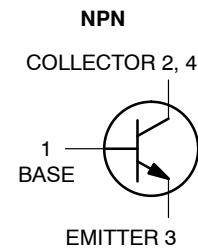

### MARKING DIAGRAM

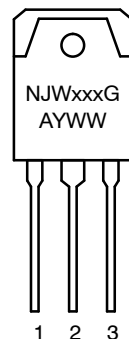

TO-3P  
PLASTIC  
CASE 340AB

xxx = TBD  
G = Pb-Free Package  
A = Assembly Location  
Y = Year  
WW = Work Week

### ORDERING INFORMATION

Device	Package	Shipping
NJW44H11G	TO-3P (Pb-Free)	30 Units/Rail

# NJW44H11G

## ELECTRICAL CHARACTERISTICS (T<sub>A</sub> = 25°C unless otherwise noted)

Characteristic	Symbol	Min	Typ	Max	Unit
----------------	--------	-----	-----	-----	------

### OFF CHARACTERISTICS

Collector–Emitter Sustaining Voltage (I <sub>C</sub> = 30 mAdc, I <sub>B</sub> = 0)	V <sub>CEO</sub>	80	–	–	Vdc
Collector–Cutoff Current (V <sub>CE</sub> = Rated V <sub>CEO</sub> , V <sub>BE</sub> = 0)	I <sub>CES</sub>	–	–	10	μAdc
Emitter Cutoff Current (V <sub>BE</sub> = 5.0 Vdc)	I <sub>EBO</sub>	–	–	10	μAdc

### ON CHARACTERISTICS

DC Current Gain (I <sub>C</sub> = 2 A, V <sub>CE</sub> = 2 V) (I <sub>C</sub> = 4 A, V <sub>CE</sub> = 2 V)	h <sub>FE</sub>	100 80	– –	400 320	–
Collector–Emitter Saturation Voltage (I <sub>C</sub> = 8 A, I <sub>B</sub> = 400 mA)	V <sub>CE(sat)</sub>	–	–	1.0	V
Base–Emitter Turn-on Voltage (I <sub>C</sub> = 8 A, V <sub>CE</sub> = 2.0 V)	V <sub>BE(on)</sub>	–	–	1.5	V

### DYNAMIC CHARACTERISTICS

Output Capacitance (V <sub>CB</sub> = 10 V, f = 1.0 MHz)	C <sub>obo</sub>	–	65	–	pF
Cutoff Frequency (I <sub>C</sub> = 500 mA, V <sub>CE</sub> = 5 V, f = 1.0 MHz)	f <sub>T</sub>	–	85	–	MHz

### SWITCHING TIMES

Delay and Rise Times (I <sub>C</sub> = 5.0 Adc, I <sub>B1</sub> = 0.5 A)	t <sub>d</sub> + t <sub>r</sub>	–	300	–	ns
Storage Time (I <sub>C</sub> = 5.0 Adc, I <sub>B1</sub> = I <sub>B2</sub> = 0.5 A)	t <sub>s</sub>	–	500	–	ns
Fall Time (I <sub>C</sub> = 5.0 Adc, I <sub>B1</sub> = I <sub>B2</sub> = 0.5 A)	t <sub>f</sub>	–	140	–	ns

TYPICAL CHARACTERISTICS

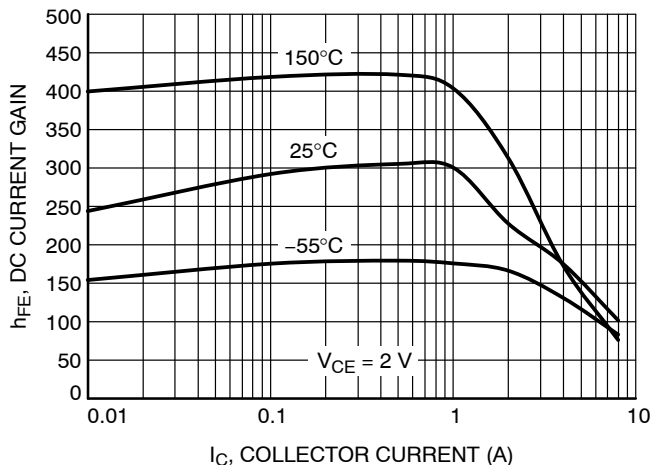

Figure 1. DC Current Gain

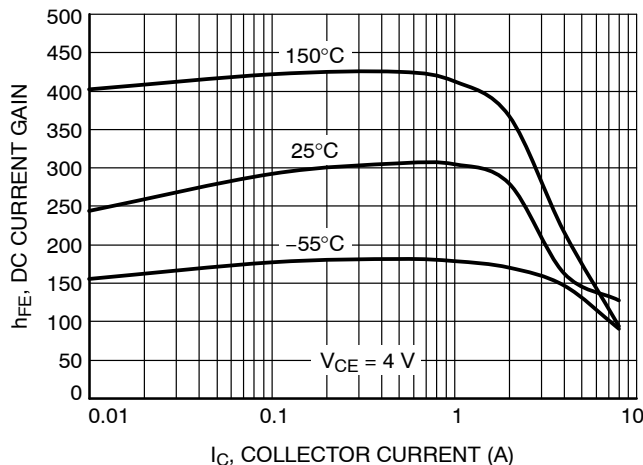

Figure 2. DC Current Gain

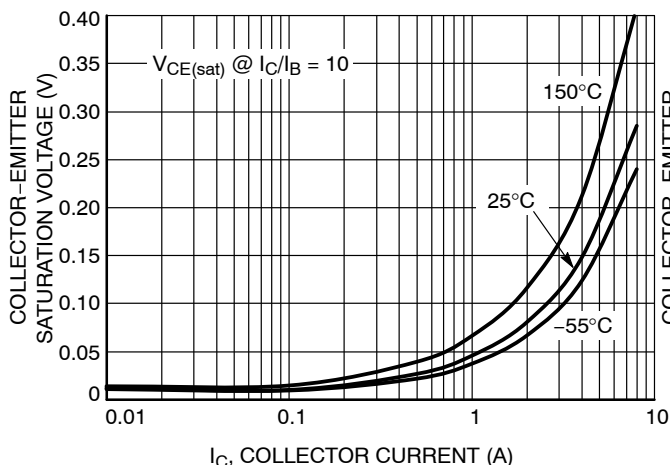

Figure 3. Collector Emitter Saturation Voltage

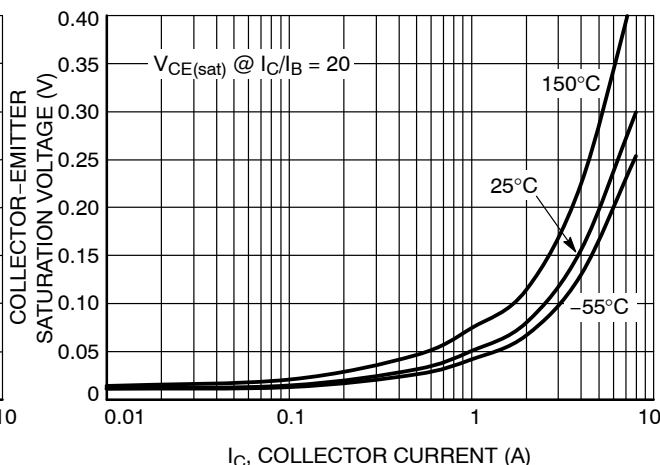

Figure 4. Collector Emitter Saturation Voltage

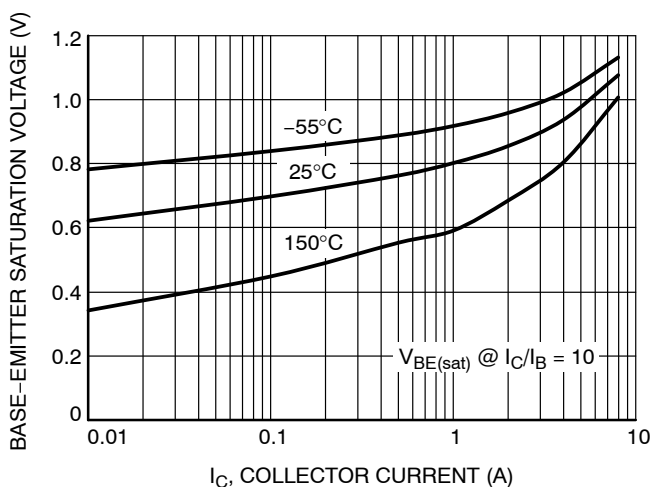

Figure 5. Base Emitter Saturation Voltage

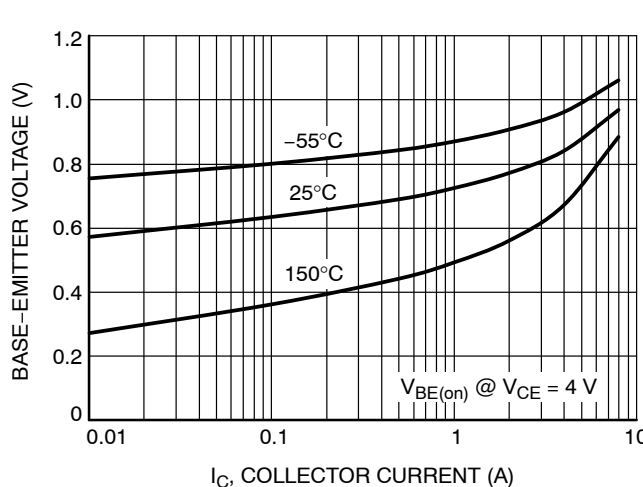

Figure 6. Base Emitter "ON" Voltage

# NJW44H11G

## TYPICAL CHARACTERISTICS

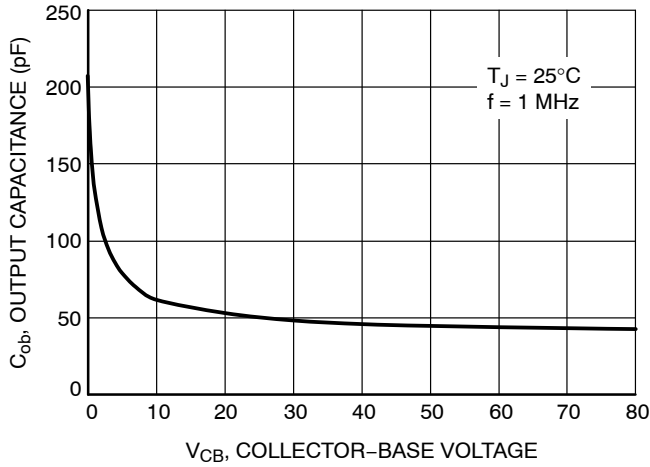

Figure 7. Output Capacitance

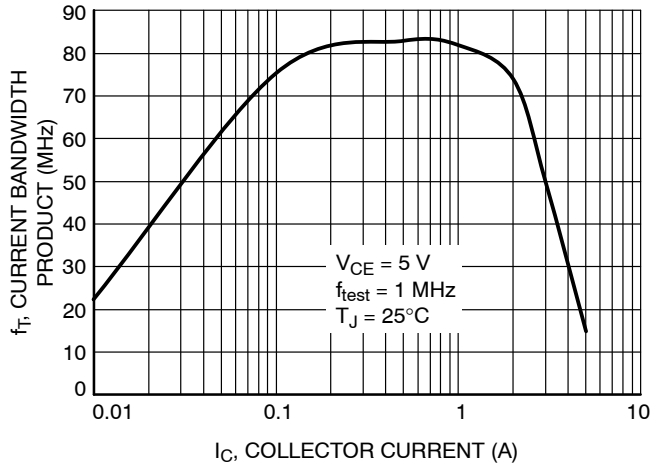

Figure 8. Current Gain Bandwidth Product

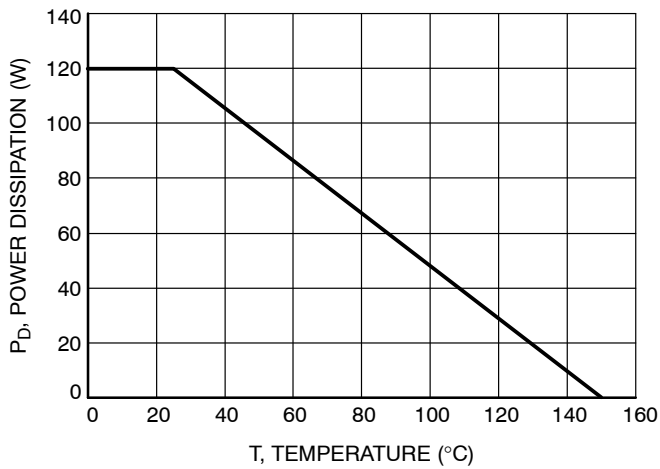

Figure 9. Power Temperature Derating

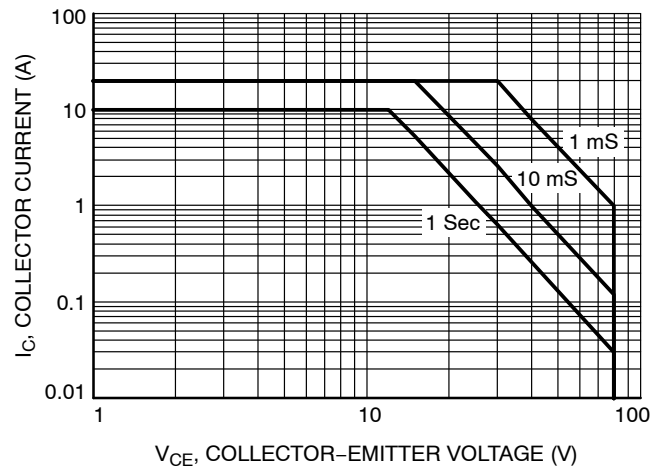

Figure 10. Safe Operating Area (SOA)

# MECHANICAL CASE OUTLINE PACKAGE DIMENSIONS

ON Semiconductor®



## TO-3P-3LD CASE 340AB-01 ISSUE A

DATE 30 OCT 2007

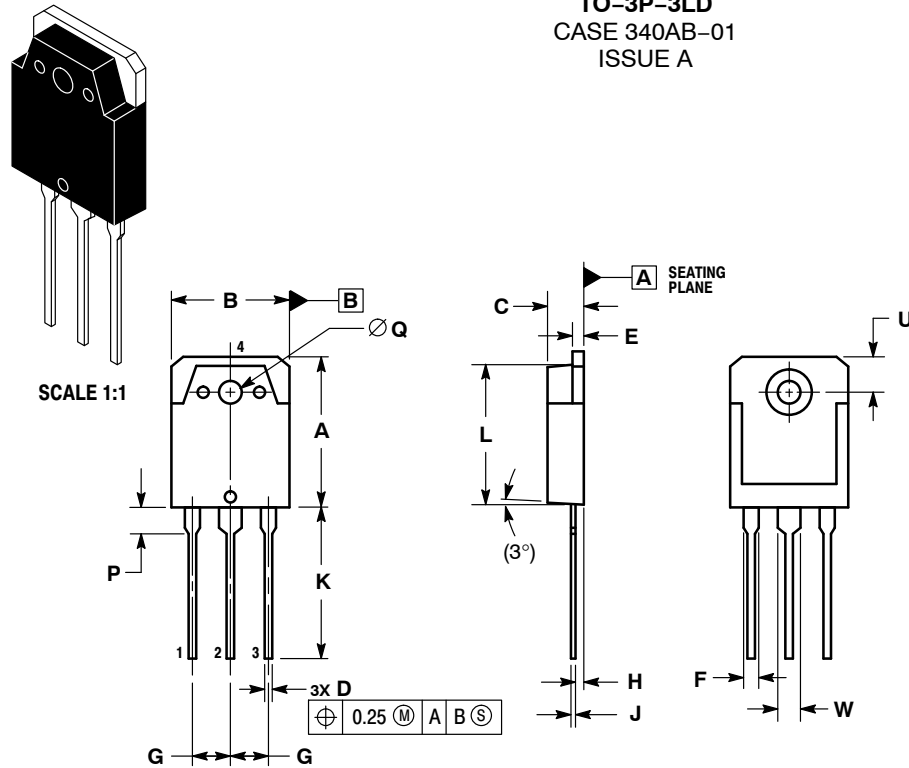

NOTES:

1. DIMENSIONING AND TOLERANCING PER ASME Y14.5M, 1994.
2. CONTROLLING DIMENSION: MILLIMETERS
3. DIMENSION b APPLIES TO PLATED TERMINAL AND IS MEASURED BETWEEN 0.15 AND 0.30mm FROM THE TERMINAL TIP.
4. DIMENSION A AND B DO NOT INCLUDE MOLD FLASH, PROTRUSIONS, OR GATE BURRS.

DIM	MILLIMETERS		
	MIN	NOM	MAX
A	19.70	19.90	20.10
B	15.40	15.60	15.80
C	4.60	4.80	5.00
D	0.80	1.00	1.20
E	1.45	1.50	1.65
F	1.80	2.00	2.20
G	5.45 BSC		
H	1.20	1.40	1.60
J	0.55	0.60	0.75
K	19.80	20.00	20.20
L	18.50	18.70	18.90
P	3.30	3.50	3.70
Q	3.10	3.20	3.50
U	5.00 REF		
W	2.80	3.00	3.20

- |              |              |             |
|--------------|--------------|-------------|
| STYLE 1:     | STYLE 2:     | STYLE 3:    |
| PIN 1. BASE  | PIN 1. ANODE | PIN 1. GATE |
| 2. COLLECTOR | 2. CATHODE   | 2. DRAIN    |
| 3. EMITTER   | 3. ANODE     | 3. SOURCE   |
| 4. COLLECTOR | 4. CATHODE   | 4. DRAIN    |

### GENERIC MARKING DIAGRAM\*

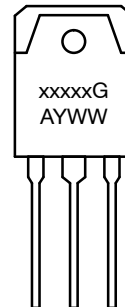

- xxxxx = Specific Device Code
- G = Pb-Free Package
- A = Assembly Location
- Y = Year
- WW = Work Week

\*This information is generic. Please refer to device data sheet for actual part marking. Pb-Free indicator, "G", may or not be present.

DOCUMENT NUMBER:	98AON25095D	Electronic versions are uncontrolled except when accessed directly from the Document Repository. Printed versions are uncontrolled except when stamped "CONTROLLED COPY" in red.
DESCRIPTION:	TO-3P-3LD	PAGE 1 OF 1

ON Semiconductor and are trademarks of Semiconductor Components Industries, LLC dba ON Semiconductor or its subsidiaries in the United States and/or other countries. ON Semiconductor reserves the right to make changes without further notice to any products herein. ON Semiconductor makes no warranty, representation or guarantee regarding the suitability of its products for any particular purpose, nor does ON Semiconductor assume any liability arising out of the application or use of any product or circuit, and specifically disclaims any and all liability, including without limitation special, consequential or incidental damages. ON Semiconductor does not convey any license under its patent rights nor the rights of others.

ON Semiconductor and  are trademarks of Semiconductor Components Industries, LLC dba ON Semiconductor or its subsidiaries in the United States and/or other countries. ON Semiconductor owns the rights to a number of patents, trademarks, copyrights, trade secrets, and other intellectual property. A listing of ON Semiconductor's product/patent coverage may be accessed at [www.onsemi.com/site/pdf/Patent-Marking.pdf](http://www.onsemi.com/site/pdf/Patent-Marking.pdf). ON Semiconductor reserves the right to make changes without further notice to any products herein. ON Semiconductor makes no warranty, representation or guarantee regarding the suitability of its products for any particular purpose, nor does ON Semiconductor assume any liability arising out of the application or use of any product or circuit, and specifically disclaims any and all liability, including without limitation special, consequential or incidental damages. Buyer is responsible for its products and applications using ON Semiconductor products, including compliance with all laws, regulations and safety requirements or standards, regardless of any support or applications information provided by ON Semiconductor. "Typical" parameters which may be provided in ON Semiconductor data sheets and/or specifications can and do vary in different applications and actual performance may vary over time. All operating parameters, including "Typicals" must be validated for each customer application by customer's technical experts. ON Semiconductor does not convey any license under its patent rights nor the rights of others. ON Semiconductor products are not designed, intended, or authorized for use as a critical component in life support systems or any FDA Class 3 medical devices or medical devices with a same or similar classification in a foreign jurisdiction or any devices intended for implantation in the human body. Should Buyer purchase or use ON Semiconductor products for any such unintended or unauthorized application, Buyer shall indemnify and hold ON Semiconductor and its officers, employees, subsidiaries, affiliates, and distributors harmless against all claims, costs, damages, and expenses, and reasonable attorney fees arising out of, directly or indirectly, any claim of personal injury or death associated with such unintended or unauthorized use, even if such claim alleges that ON Semiconductor was negligent regarding the design or manufacture of the part. ON Semiconductor is an Equal Opportunity/Affirmative Action Employer. This literature is subject to all applicable copyright laws and is not for resale in any manner.

## PUBLICATION ORDERING INFORMATION

### LITERATURE FULFILLMENT:

Email Requests to: [orderlit@onsemi.com](mailto:orderlit@onsemi.com)

ON Semiconductor Website: [www.onsemi.com](http://www.onsemi.com)

### TECHNICAL SUPPORT

North American Technical Support:  
Voice Mail: 1 800-282-9855 Toll Free USA/Canada  
Phone: 011 421 33 790 2910

### Europe, Middle East and Africa Technical Support:

Phone: 00421 33 790 2910

For additional information, please contact your local Sales Representative

