

NTMD4N03, NVMD4N03

MOSFET – Power, Dual, N-Channel, SO-8 4 A, 30 V

Features

- Designed for use in low voltage, high speed switching applications
- Ultra Low On-Resistance Provides Higher Efficiency and Extends Battery Life
 - $R_{DS(on)} = 0.048 \Omega$, $V_{GS} = 10 \text{ V}$ (Typ)
 - $R_{DS(on)} = 0.065 \Omega$, $V_{GS} = 4.5 \text{ V}$ (Typ)
- Miniature SO-8 Surface Mount Package – Saves Board Space
- Diode is Characterized for Use in Bridge Circuits
- Diode Exhibits High Speed, with Soft Recovery
- NVMD Prefix for Automotive and Other Applications Requiring Unique Site and Control Change Requirements; AEC-Q101 Qualified and PPAP Capable*
- These Devices are Pb-Free and are RoHS Compliant

Applications

- DC-DC Converters
- Computers
- Printers
- Cellular and Cordless Phones
- Disk Drives and Tape Drives

MAXIMUM RATINGS ($T_J = 25^\circ\text{C}$ unless otherwise noted)

| Rating | Symbol | Value | Unit |
|---|-----------------|-------------|--------------------|
| Drain-to-Source Voltage | V_{DSS} | 30 | V |
| Gate-to-Source Voltage – Continuous | V_{GS} | ± 20 | V |
| Drain Current | | | |
| – Continuous @ $T_A = 25^\circ\text{C}$ | I_D | 4.0 | Adc |
| – Single Pulse ($t_p \leq 10 \mu\text{s}$) | I_{DM} | 12 | Apk |
| Total Power Dissipation @ $T_A = 25^\circ\text{C}$ (Note 1) | P_D | 2.0 | W |
| Operating and Storage Temperature Range | T_J, T_{stg} | -55 to +150 | $^\circ\text{C}$ |
| Single Pulse Drain-to-Source Avalanche Energy – Starting $T_J = 25^\circ\text{C}$ ($V_{DD} = 25 \text{ Vdc}$, $V_{GS} = 5.0 \text{ Vdc}$, Peak $I_L = 4.45 \text{ Apk}$, $L = 8 \text{ mH}$, $R_G = 25 \Omega$) | E_{AS} | 80 | mJ |
| Thermal Resistance – Junction-to-Ambient (Note 1) | $R_{\theta JA}$ | 62.5 | $^\circ\text{C/W}$ |
| Maximum Lead Temperature for Soldering Purposes for 10 seconds | T_L | 260 | $^\circ\text{C}$ |

Stresses exceeding Maximum Ratings may damage the device. Maximum Ratings are stress ratings only. Functional operation above the Recommended Operating Conditions is not implied. Extended exposure to stresses above the Recommended Operating Conditions may affect device reliability.

1. When surface mounted to an FR4 board using 1" pad size, $t \leq 10 \text{ s}$



ON Semiconductor®

<http://onsemi.com>

| V_{DSS} | $R_{DS(on)}$ Typ | I_D Max |
|-----------|---|-----------|
| 30 V | 48 m Ω @ $V_{GS} = 10 \text{ V}$ | 4.0 A |

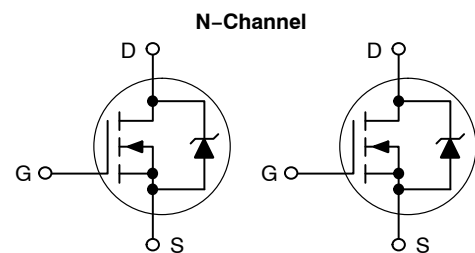

MARKING DIAGRAM* AND PIN ASSIGNMENT



SOIC-8
SUFFIX NB
CASE 751
STYLE 11

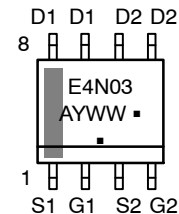

E4N03 = Specific Device Code
A = Assembly Location
Y = Year
WW = Work Week
▪ = Pb-Free Package

(Note: Microdot may be in either location)

*For additional marking information, refer to Application Note AND8002/D.

ORDERING INFORMATION

| Device | Package | Shipping† |
|--------------|------------------|--------------------|
| NTMD4N03R2G | SOIC-8 (Pb-Free) | 2500 / Tape & Reel |
| NVMD4N03R2G* | SOIC-8 (Pb-Free) | 2500 / Tape & Reel |

†For information on tape and reel specifications, including part orientation and tape sizes, please refer to our Tape and Reel Packaging Specifications Brochure, BRD8011/D

NTMD4N03, NVMD4N03

ELECTRICAL CHARACTERISTICS (T_C = 25°C unless otherwise noted)

| Characteristic | Symbol | Min | Typ | Max | Unit |
|----------------|--------|-----|-----|-----|------|
|----------------|--------|-----|-----|-----|------|

OFF CHARACTERISTICS

| | | | | | |
|--|----------------------|---------|---------|-----------|--------------|
| Drain-to-Source Breakdown Voltage (V _{GS} = 0 Vdc, I _D = 250 μA) Temperature Coefficient (Positive) | V _{(BR)DSS} | 30 - | - 32 | - - | Vdc mV/°C |
| Zero Gate Voltage Drain Current (V _{DS} = 30 Vdc, V _{GS} = 0 Vdc, T _J = 25°C) (V _{DS} = 30 Vdc, V _{GS} = 0 Vdc, T _J = 125°C) | I _{DSS} | - - | - - | 1.0 10 | μAdc |
| Gate-Body Leakage Current (V _{GS} = ±20 Vdc, V _{DS} = 0 Vdc) | I _{GSS} | - | - | 100 | nAdc |

ON CHARACTERISTICS (Note 2)

| | | | | | |
|---|---------------------|----------|----------------|----------------|--------------|
| Gate Threshold Voltage (V _{DS} = V _{GS} , I _D = 250 μAdc) Temperature Coefficient (Negative) | V _{GS(th)} | 1.0 - | 1.9 4.2 | 3.0 - | Vdc mV/°C |
| Static Drain-to-Source On-State Resistance (V _{GS} = 10 Vdc, I _D = 4 Adc) (V _{GS} = 4.5 Vdc, I _D = 2 Adc) | R _{DS(on)} | - - | 0.048 0.065 | 0.060 0.080 | Ω |
| Forward Transconductance (V _{DS} = 3 Vdc, I _D = 2 Adc) | g _{FS} | - | 6.0 | - | Mhos |

DYNAMIC CHARACTERISTICS

| | | | | | | |
|------------------------------|---|------------------|---|-----|-----|----|
| Input Capacitance | (V _{DS} = 20 Vdc, V _{GS} = 0 Vdc, f = 1.0 MHz) | C _{ISS} | - | 285 | 400 | pF |
| Output Capacitance | | C _{OSS} | - | 95 | 135 | |
| Reverse Transfer Capacitance | | C _{RSS} | - | 35 | 70 | |

SWITCHING CHARACTERISTICS (Notes 2 & 3)

| | | | | | | |
|---------------------|--|---------------------|---|-----|----|----|
| Turn-On Delay Time | (V _{DD} = 20 Vdc, I _D = 2 A, V _{GS} = 10 V, R _G = 2 Ω) | t _{d(on)} | - | 7.0 | 15 | ns |
| Rise Time | | t _r | - | 14 | 30 | |
| Turn-Off Delay Time | | t _{d(off)} | - | 16 | 30 | |
| Fall Time | | t _f | - | 10 | 20 | |
| Gate Charge | (V _{DS} = 10 Vdc, V _{GS} = 10 Vdc, I _D = 3.5 A) | Q _T | - | 8.0 | 16 | nC |
| | | Q ₁ | - | 1.1 | - | |
| | | Q ₂ | - | 1.9 | - | |

BODY-DRAIN DIODE RATINGS (Note 2)

| | | | | | | |
|---|--|-----------------|--------|--------------|----------|-----|
| Diode Forward On-Voltage | (I _S = 2 Adc, V _{GS} = 0 V) (I _S = 2 Adc, V _{GS} = 0 V, T _J = 150°C) | V _{SD} | - - | 0.82 0.63 | 1.0 - | Vdc |
| Reverse Recovery Time | (I _S = 2 A, V _{GS} = 0 V, di/dt = 100 A/μs) | t _{rr} | - | 14 | - | ns |
| | | t _a | - | 10 | - | |
| | | t _b | - | 4.0 | - | |
| Reverse Recovery Stored Charge (I _S = 2 A, di/dt = 100 A/μs, V _{GS} = 0 V) | | Q _{RR} | - | 0.008 | - | μC |

2. Pulse Test: Pulse Width ≤ 300 μs, Duty Cycle ≤ 2%.
3. Switching characteristics are independent of operating junction temperature.

TYPICAL MOSFET ELECTRICAL CHARACTERISTICS

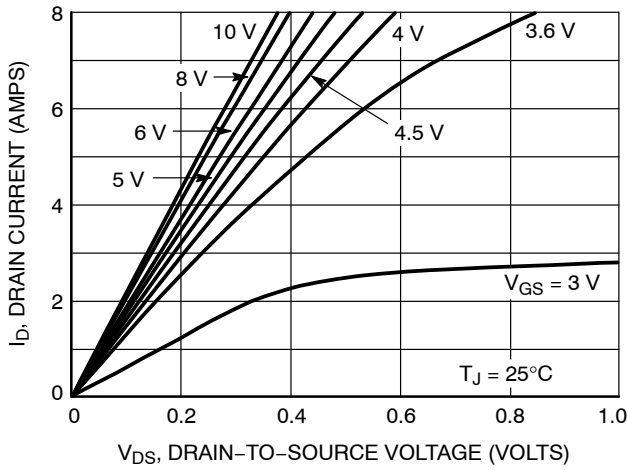

Figure 1. On-Region Characteristics

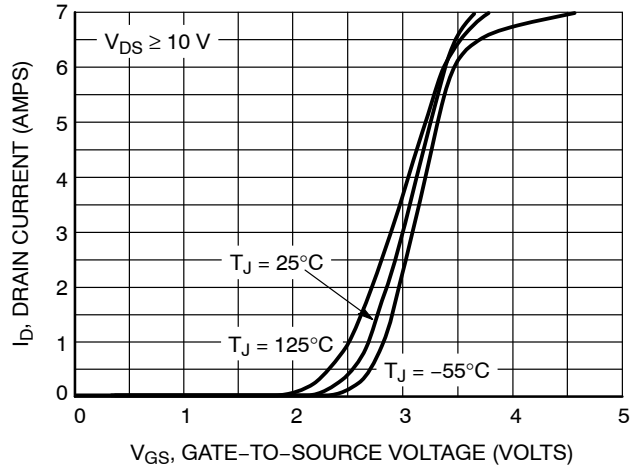

Figure 2. Transfer Characteristics

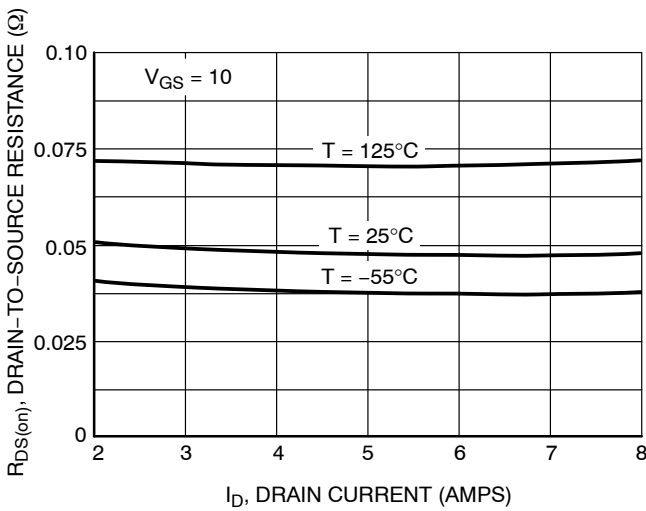

Figure 3. On-Resistance versus Drain Current and Temperature

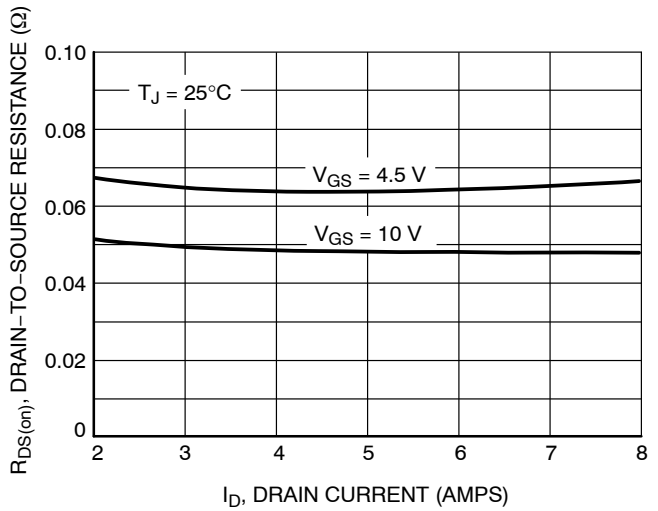

Figure 4. On-Resistance versus Drain Current and Gate Voltage

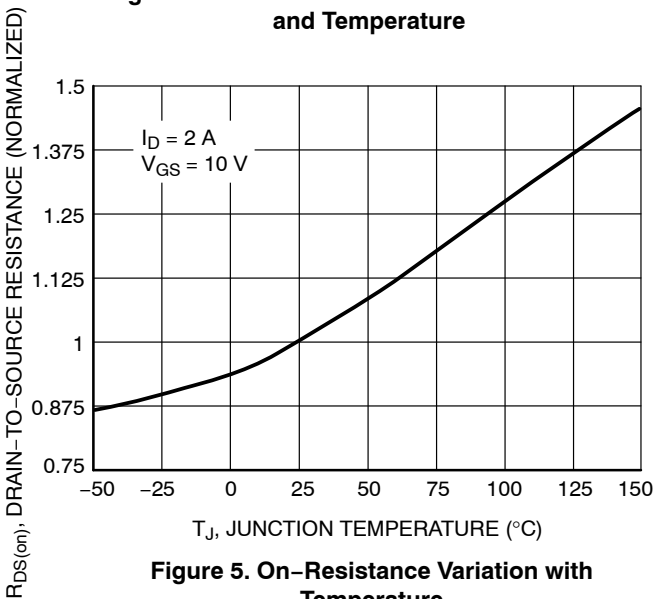

Figure 5. On-Resistance Variation with Temperature

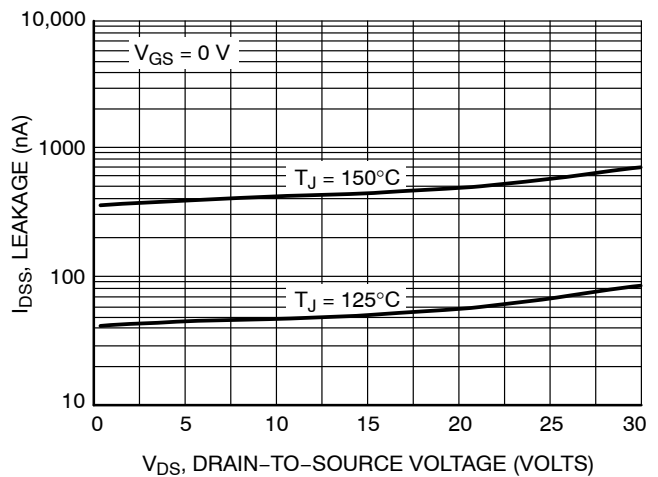

Figure 6. Drain-to-Source Leakage Current versus Voltage

POWER MOSFET SWITCHING

Switching behavior is most easily modeled and predicted by recognizing that the power MOSFET is charge controlled. The lengths of various switching intervals (Δt) are determined by how fast the FET input capacitance can be charged by current from the generator.

The published capacitance data is difficult to use for calculating rise and fall because drain-gate capacitance varies greatly with applied voltage. Accordingly, gate charge data is used. In most cases, a satisfactory estimate of average input current ($I_{G(AV)}$) can be made from a rudimentary analysis of the drive circuit so that

$$t = Q/I_{G(AV)}$$

During the rise and fall time interval when switching a resistive load, V_{GS} remains virtually constant at a level known as the plateau voltage, V_{SGSP} . Therefore, rise and fall times may be approximated by the following:

$$t_r = Q_2 \times R_G / (V_{GG} - V_{SGSP})$$

$$t_f = Q_2 \times R_G / V_{SGSP}$$

where

V_{GG} = the gate drive voltage, which varies from zero to V_{GG}

R_G = the gate drive resistance

and Q_2 and V_{SGSP} are read from the gate charge curve.

During the turn-on and turn-off delay times, gate current is not constant. The simplest calculation uses appropriate values from the capacitance curves in a standard equation for voltage change in an RC network. The equations are:

$$t_{d(on)} = R_G C_{iss} \ln [V_{GG}/(V_{GG} - V_{SGSP})]$$

$$t_{d(off)} = R_G C_{iss} \ln (V_{GG}/V_{SGSP})$$

The capacitance (C_{iss}) is read from the capacitance curve at a voltage corresponding to the off-state condition when calculating $t_{d(on)}$ and is read at a voltage corresponding to the on-state when calculating $t_{d(off)}$.

At high switching speeds, parasitic circuit elements complicate the analysis. The inductance of the MOSFET source lead, inside the package and in the circuit wiring which is common to both the drain and gate current paths, produces a voltage at the source which reduces the gate drive current. The voltage is determined by $L di/dt$, but since di/dt is a function of drain current, the mathematical solution is complex. The MOSFET output capacitance also complicates the mathematics. And finally, MOSFETs have finite internal gate resistance which effectively adds to the resistance of the driving source, but the internal resistance is difficult to measure and, consequently, is not specified.

The resistive switching time variation versus gate resistance (Figure 9) shows how typical switching performance is affected by the parasitic circuit elements. If the parasitics were not present, the slope of the curves would maintain a value of unity regardless of the switching speed. The circuit used to obtain the data is constructed to minimize common inductance in the drain and gate circuit loops and is believed readily achievable with board mounted components. Most power electronic loads are inductive; the data in the figure is taken with a resistive load, which approximates an optimally snubbed inductive load. Power MOSFETs may be safely operated into an inductive load; however, snubbing reduces switching losses.

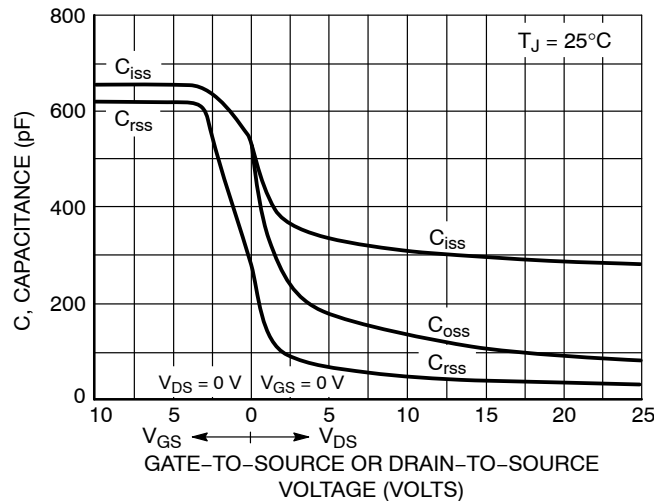

Figure 7. Capacitance Variation

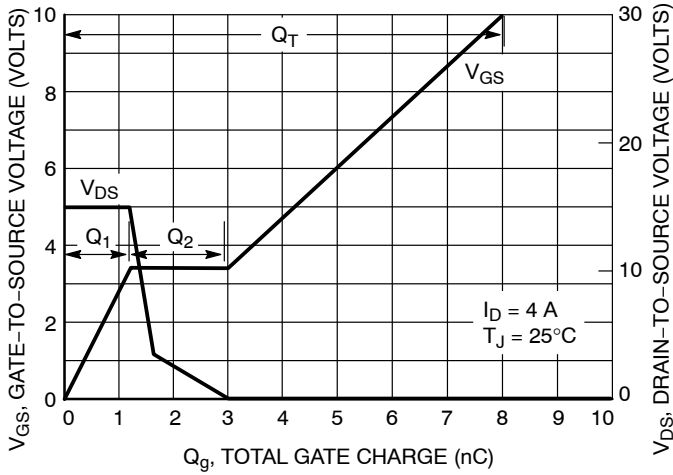

Figure 8. Gate-to-Source and Drain-to-Source Voltage versus Total Charge

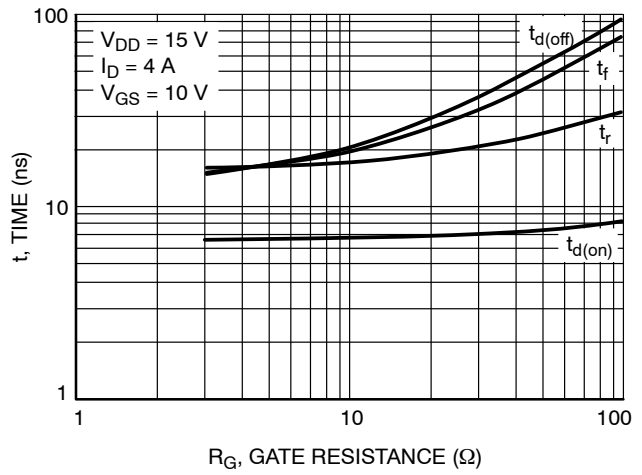

Figure 9. Resistive Switching Time Variation versus Gate Resistance

DRAIN-TO-SOURCE DIODE CHARACTERISTICS

The switching characteristics of a MOSFET body diode are very important in systems using it as a freewheeling or commutating diode. Of particular interest are the reverse recovery characteristics which play a major role in determining switching losses, radiated noise, EMI and RFI.

System switching losses are largely due to the nature of the body diode itself. The body diode is a minority carrier device, therefore it has a finite reverse recovery time, t_{rr} , due to the storage of minority carrier charge, Q_{RR} , as shown in the typical reverse recovery wave form of Figure 14. It is this stored charge that, when cleared from the diode, passes through a potential and defines an energy loss. Obviously, repeatedly forcing the diode through reverse recovery further increases switching losses. Therefore, one would like a diode with short t_{rr} and low Q_{RR} specifications to minimize these losses.

The abruptness of diode reverse recovery effects the amount of radiated noise, voltage spikes, and current ringing. The mechanisms at work are finite irremovable circuit parasitic inductances and capacitances acted upon by

high di/dt s. The diode's negative di/dt during t_a is directly controlled by the device clearing the stored charge. However, the positive di/dt during t_b is an uncontrollable diode characteristic and is usually the culprit that induces current ringing. Therefore, when comparing diodes, the ratio of t_b/t_a serves as a good indicator of recovery abruptness and thus gives a comparative estimate of probable noise generated. A ratio of 1 is considered ideal and values less than 0.5 are considered snappy.

Compared to ON Semiconductor standard cell density low voltage MOSFETs, high cell density MOSFET diodes are faster (shorter t_{rr}), have less stored charge and a softer reverse recovery characteristic. The softness advantage of the high cell density diode means they can be forced through reverse recovery at a higher di/dt than a standard cell MOSFET diode without increasing the current ringing or the noise generated. In addition, power dissipation incurred from switching the diode will be less due to the shorter recovery time and lower switching losses.

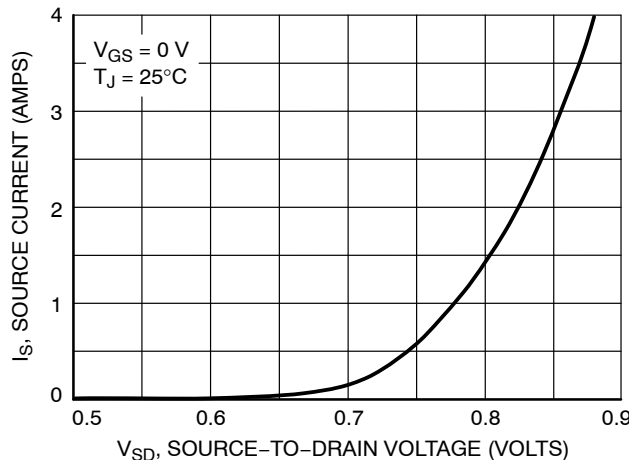

Figure 10. Diode Forward Voltage versus Current

NTMD4N03, NVMD4N03

SAFE OPERATING AREA

The Forward Biased Safe Operating Area curves define the maximum simultaneous drain-to-source voltage and drain current that a transistor can handle safely when it is forward biased. Curves are based upon maximum peak junction temperature and a case temperature (T_C) of 25°C. Peak repetitive pulsed power limits are determined by using the thermal response data in conjunction with the procedures discussed in AN569, "Transient Thermal Resistance – General Data and Its Use."

Switching between the off-state and the on-state may traverse any load line provided neither rated peak current (I_{DM}) nor rated voltage (V_{DSS}) is exceeded, and that the transition time (t_r , t_f) does not exceed 10 μ s. In addition the

total power averaged over a complete switching cycle must not exceed $(T_{J(MAX)} - T_C)/(R_{\theta JC})$.

A power MOSFET designated E-FET can be safely used in switching circuits with unclamped inductive loads. For reliable operation, the stored energy from circuit inductance dissipated in the transistor while in avalanche must be less than the rated limit and must be adjusted for operating conditions differing from those specified. Although industry practice is to rate in terms of energy, avalanche energy capability is not a constant. The energy rating decreases non-linearly with an increase of peak current in avalanche and peak junction temperature.

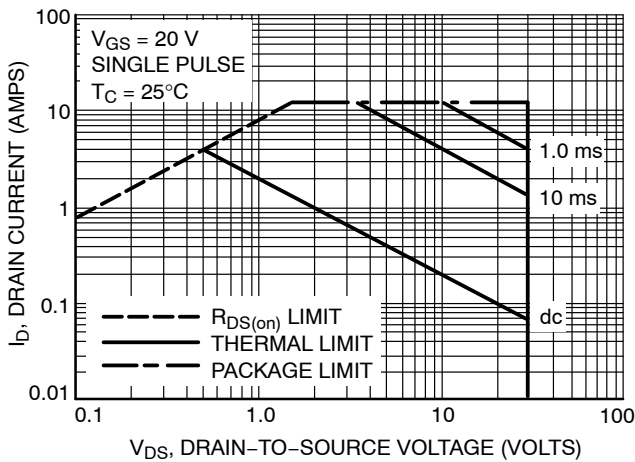

Figure 11. Maximum Rated Forward Biased Safe Operating Area

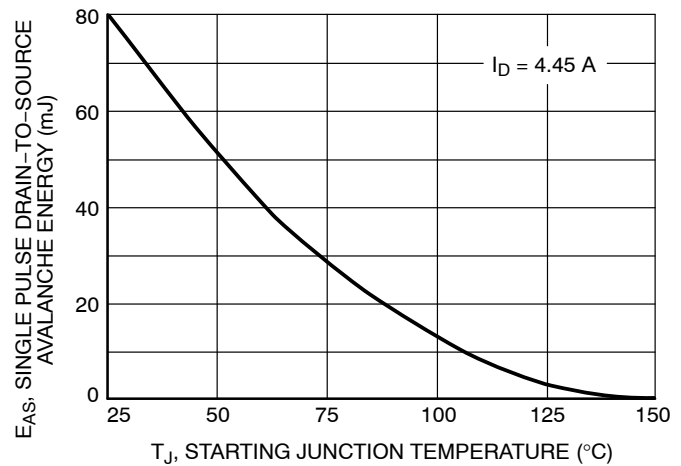

Figure 12. Maximum Avalanche Energy versus Starting Junction Temperature

NTMD4N03, NVMD4N03

TYPICAL ELECTRICAL CHARACTERISTICS

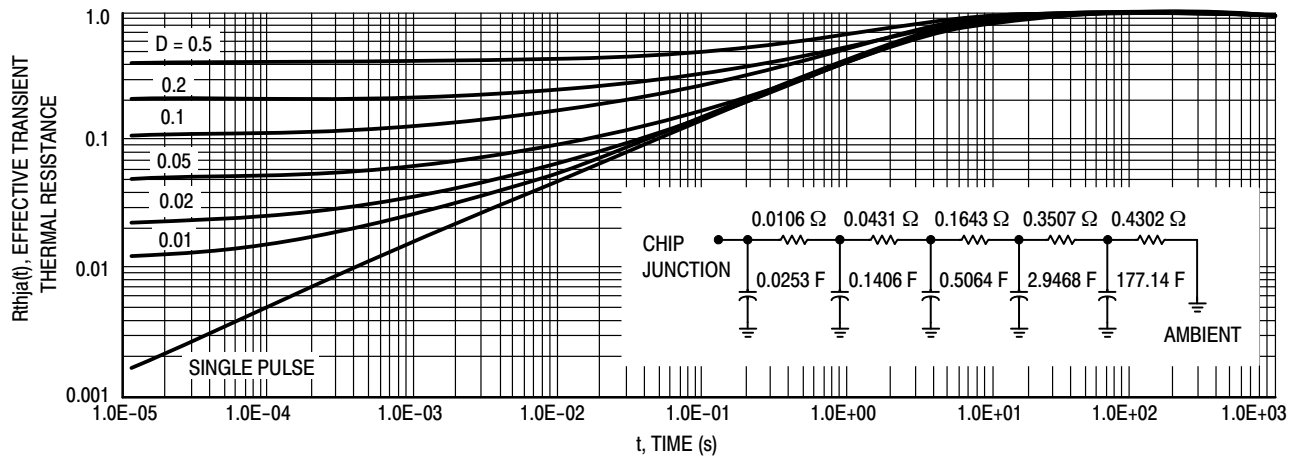

Figure 13. Thermal Response

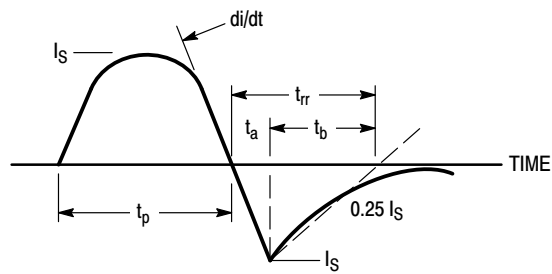

Figure 14. Diode Reverse Recovery Waveform

MECHANICAL CASE OUTLINE PACKAGE DIMENSIONS



SCALE 1:1

SOIC-8 NB
CASE 751-07
ISSUE AK

DATE 16 FEB 2011

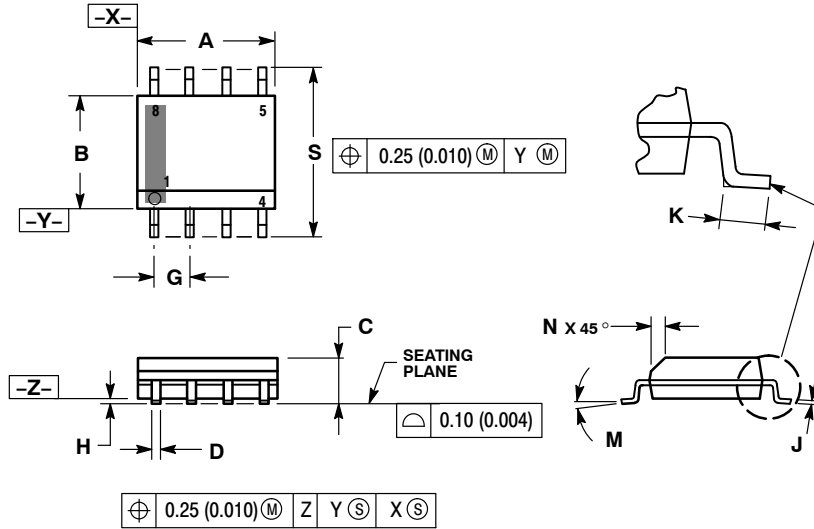

- NOTES:
1. DIMENSIONING AND TOLERANCING PER ANSI Y14.5M, 1982.
 2. CONTROLLING DIMENSION: MILLIMETER.
 3. DIMENSION A AND B DO NOT INCLUDE MOLD PROTRUSION.
 4. MAXIMUM MOLD PROTRUSION 0.15 (0.006) PER SIDE.
 5. DIMENSION D DOES NOT INCLUDE DAMBAR PROTRUSION. ALLOWABLE DAMBAR PROTRUSION SHALL BE 0.127 (0.005) TOTAL IN EXCESS OF THE D DIMENSION AT MAXIMUM MATERIAL CONDITION.
 6. 751-01 THRU 751-06 ARE OBSOLETE. NEW STANDARD IS 751-07.

| DIM | MILLIMETERS | | INCHES | |
|-----|-------------|------|-----------|-------|
| | MIN | MAX | MIN | MAX |
| A | 4.80 | 5.00 | 0.189 | 0.197 |
| B | 3.80 | 4.00 | 0.150 | 0.157 |
| C | 1.35 | 1.75 | 0.053 | 0.069 |
| D | 0.33 | 0.51 | 0.013 | 0.020 |
| G | 1.27 BSC | | 0.050 BSC | |
| H | 0.10 | 0.25 | 0.004 | 0.010 |
| J | 0.19 | 0.25 | 0.007 | 0.010 |
| K | 0.40 | 1.27 | 0.016 | 0.050 |
| M | 0° | 8° | 0° | 8° |
| N | 0.25 | 0.50 | 0.010 | 0.020 |
| S | 5.80 | 6.20 | 0.228 | 0.244 |

SOLDERING FOOTPRINT*



*For additional information on our Pb-Free strategy and soldering details, please download the ON Semiconductor Soldering and Mounting Techniques Reference Manual, SOLDERRM/D.

GENERIC MARKING DIAGRAM*



XXXXXX = Specific Device Code
A = Assembly Location
L = Wafer Lot
Y = Year
W = Work Week
▪ = Pb-Free Package

XXXXXX = Specific Device Code
A = Assembly Location
Y = Year
WW = Work Week
▪ = Pb-Free Package

*This information is generic. Please refer to device data sheet for actual part marking. Pb-Free indicator, "G" or microdot "▪", may or may not be present. Some products may not follow the Generic Marking.

STYLES ON PAGE 2

| | | |
|------------------|-------------|--|
| DOCUMENT NUMBER: | 98ASB42564B | Electronic versions are uncontrolled except when accessed directly from the Document Repository. Printed versions are uncontrolled except when stamped "CONTROLLED COPY" in red. |
| DESCRIPTION: | SOIC-8 NB | PAGE 1 OF 2 |

onsemi and ONsemi are trademarks of Semiconductor Components Industries, LLC dba onsemi or its subsidiaries in the United States and/or other countries. onsemi reserves the right to make changes without further notice to any products herein. onsemi makes no warranty, representation or guarantee regarding the suitability of its products for any particular purpose, nor does onsemi assume any liability arising out of the application or use of any product or circuit, and specifically disclaims any and all liability, including without limitation special, consequential or incidental damages. onsemi does not convey any license under its patent rights nor the rights of others.

SOIC-8 NB
CASE 751-07
ISSUE AK

DATE 16 FEB 2011

- | | | | |
|--|---|---|---|
| <p>STYLE 1: PIN 1. EMITTER 2. COLLECTOR 3. COLLECTOR 4. EMITTER 5. EMITTER 6. BASE 7. BASE 8. EMITTER</p> | <p>STYLE 2: PIN 1. COLLECTOR, DIE, #1 2. COLLECTOR, #1 3. COLLECTOR, #2 4. COLLECTOR, #2 5. BASE, #2 6. EMITTER, #2 7. BASE, #1 8. EMITTER, #1</p> | <p>STYLE 3: PIN 1. DRAIN, DIE #1 2. DRAIN, #1 3. DRAIN, #2 4. DRAIN, #2 5. GATE, #2 6. SOURCE, #2 7. GATE, #1 8. SOURCE, #1</p> | <p>STYLE 4: PIN 1. ANODE 2. ANODE 3. ANODE 4. ANODE 5. ANODE 6. ANODE 7. ANODE 8. COMMON CATHODE</p> |
| <p>STYLE 5: PIN 1. DRAIN 2. DRAIN 3. DRAIN 4. DRAIN 5. GATE 6. GATE 7. SOURCE 8. SOURCE</p> | <p>STYLE 6: PIN 1. SOURCE 2. DRAIN 3. DRAIN 4. SOURCE 5. SOURCE 6. GATE 7. GATE 8. SOURCE</p> | <p>STYLE 7: PIN 1. INPUT 2. EXTERNAL BYPASS 3. THIRD STAGE SOURCE 4. GROUND 5. DRAIN 6. GATE 3 7. SECOND STAGE Vd 8. FIRST STAGE Vd</p> | <p>STYLE 8: PIN 1. COLLECTOR, DIE #1 2. BASE, #1 3. BASE, #2 4. COLLECTOR, #2 5. COLLECTOR, #2 6. EMITTER, #2 7. EMITTER, #1 8. COLLECTOR, #1</p> |
| <p>STYLE 9: PIN 1. EMITTER, COMMON 2. COLLECTOR, DIE #1 3. COLLECTOR, DIE #2 4. EMITTER, COMMON 5. EMITTER, COMMON 6. BASE, DIE #2 7. BASE, DIE #1 8. EMITTER, COMMON</p> | <p>STYLE 10: PIN 1. GROUND 2. BIAS 1 3. OUTPUT 4. GROUND 5. GROUND 6. BIAS 2 7. INPUT 8. GROUND</p> | <p>STYLE 11: PIN 1. SOURCE 1 2. GATE 1 3. SOURCE 2 4. GATE 2 5. DRAIN 2 6. DRAIN 2 7. DRAIN 1 8. DRAIN 1</p> | <p>STYLE 12: PIN 1. SOURCE 2. SOURCE 3. SOURCE 4. GATE 5. DRAIN 6. DRAIN 7. DRAIN 8. DRAIN</p> |
| <p>STYLE 13: PIN 1. N.C. 2. SOURCE 3. SOURCE 4. GATE 5. DRAIN 6. DRAIN 7. DRAIN 8. DRAIN</p> | <p>STYLE 14: PIN 1. N-SOURCE 2. N-GATE 3. P-SOURCE 4. P-GATE 5. P-DRAIN 6. P-DRAIN 7. N-DRAIN 8. N-DRAIN</p> | <p>STYLE 15: PIN 1. ANODE 1 2. ANODE 1 3. ANODE 1 4. ANODE 1 5. CATHODE, COMMON 6. CATHODE, COMMON 7. CATHODE, COMMON 8. CATHODE, COMMON</p> | <p>STYLE 16: PIN 1. EMITTER, DIE #1 2. BASE, DIE #1 3. EMITTER, DIE #2 4. BASE, DIE #2 5. COLLECTOR, DIE #2 6. COLLECTOR, DIE #2 7. COLLECTOR, DIE #1 8. COLLECTOR, DIE #1</p> |
| <p>STYLE 17: PIN 1. VCC 2. V2OUT 3. V1OUT 4. TXE 5. RXE 6. VEE 7. GND 8. ACC</p> | <p>STYLE 18: PIN 1. ANODE 2. ANODE 3. SOURCE 4. GATE 5. DRAIN 6. DRAIN 7. CATHODE 8. CATHODE</p> | <p>STYLE 19: PIN 1. SOURCE 1 2. GATE 1 3. SOURCE 2 4. GATE 2 5. DRAIN 2 6. MIRROR 2 7. DRAIN 1 8. MIRROR 1</p> | <p>STYLE 20: PIN 1. SOURCE (N) 2. GATE (N) 3. SOURCE (P) 4. GATE (P) 5. DRAIN 6. DRAIN 7. DRAIN 8. DRAIN</p> |
| <p>STYLE 21: PIN 1. CATHODE 1 2. CATHODE 2 3. CATHODE 3 4. CATHODE 4 5. CATHODE 5 6. COMMON ANODE 7. COMMON ANODE 8. CATHODE 6</p> | <p>STYLE 22: PIN 1. I/O LINE 1 2. COMMON CATHODE/VCC 3. COMMON CATHODE/VCC 4. I/O LINE 3 5. COMMON ANODE/GND 6. I/O LINE 4 7. I/O LINE 5 8. COMMON ANODE/GND</p> | <p>STYLE 23: PIN 1. LINE 1 IN 2. COMMON ANODE/GND 3. COMMON ANODE/GND 4. LINE 2 IN 5. LINE 2 OUT 6. COMMON ANODE/GND 7. COMMON ANODE/GND 8. LINE 1 OUT</p> | <p>STYLE 24: PIN 1. BASE 2. EMITTER 3. COLLECTOR/ANODE 4. COLLECTOR/ANODE 5. CATHODE 6. CATHODE 7. COLLECTOR/ANODE 8. COLLECTOR/ANODE</p> |
| <p>STYLE 25: PIN 1. VIN 2. N/C 3. REXT 4. GND 5. IOUT 6. IOUT 7. IOUT 8. IOUT</p> | <p>STYLE 26: PIN 1. GND 2. dv/dt 3. ENABLE 4. ILIMIT 5. SOURCE 6. SOURCE 7. SOURCE 8. VCC</p> | <p>STYLE 27: PIN 1. ILIMIT 2. OVLO 3. UVLO 4. INPUT+ 5. SOURCE 6. SOURCE 7. SOURCE 8. DRAIN</p> | <p>STYLE 28: PIN 1. SW_TO_GND 2. DASIC_OFF 3. DASIC_SW_DET 4. GND 5. V_MON 6. VBULK 7. VBULK 8. VIN</p> |
| <p>STYLE 29: PIN 1. BASE, DIE #1 2. EMITTER, #1 3. BASE, #2 4. EMITTER, #2 5. COLLECTOR, #2 6. COLLECTOR, #2 7. COLLECTOR, #1 8. COLLECTOR, #1</p> | <p>STYLE 30: PIN 1. DRAIN 1 2. DRAIN 1 3. GATE 2 4. SOURCE 2 5. SOURCE 1/DRAIN 2 6. SOURCE 1/DRAIN 2 7. SOURCE 1/DRAIN 2 8. GATE 1</p> | | |

| | | |
|-------------------------|--------------------|---|
| DOCUMENT NUMBER: | 98ASB42564B | Electronic versions are uncontrolled except when accessed directly from the Document Repository. Printed versions are uncontrolled except when stamped "CONTROLLED COPY" in red. |
| DESCRIPTION: | SOIC-8 NB | PAGE 2 OF 2 |

onsemi and **ONSEMI** are trademarks of Semiconductor Components Industries, LLC dba **onsemi** or its subsidiaries in the United States and/or other countries. **onsemi** reserves the right to make changes without further notice to any products herein. **onsemi** makes no warranty, representation or guarantee regarding the suitability of its products for any particular purpose, nor does **onsemi** assume any liability arising out of the application or use of any product or circuit, and specifically disclaims any and all liability, including without limitation special, consequential or incidental damages. **onsemi** does not convey any license under its patent rights nor the rights of others.

onsemi, **Onsemi**, and other names, marks, and brands are registered and/or common law trademarks of Semiconductor Components Industries, LLC dba "**onsemi**" or its affiliates and/or subsidiaries in the United States and/or other countries. **onsemi** owns the rights to a number of patents, trademarks, copyrights, trade secrets, and other intellectual property. A listing of **onsemi**'s product/patent coverage may be accessed at www.onsemi.com/site/pdf/Patent-Marking.pdf. **onsemi** reserves the right to make changes at any time to any products or information herein, without notice. The information herein is provided "as-is" and **onsemi** makes no warranty, representation or guarantee regarding the accuracy of the information, product features, availability, functionality, or suitability of its products for any particular purpose, nor does **onsemi** assume any liability arising out of the application or use of any product or circuit, and specifically disclaims any and all liability, including without limitation special, consequential or incidental damages. Buyer is responsible for its products and applications using **onsemi** products, including compliance with all laws, regulations and safety requirements or standards, regardless of any support or applications information provided by **onsemi**. "Typical" parameters which may be provided in **onsemi** data sheets and/or specifications can and do vary in different applications and actual performance may vary over time. All operating parameters, including "Typicals" must be validated for each customer application by customer's technical experts. **onsemi** does not convey any license under any of its intellectual property rights nor the rights of others. **onsemi** products are not designed, intended, or authorized for use as a critical component in life support systems or any FDA Class 3 medical devices or medical devices with a same or similar classification in a foreign jurisdiction or any devices intended for implantation in the human body. Should Buyer purchase or use **onsemi** products for any such unintended or unauthorized application, Buyer shall indemnify and hold **onsemi** and its officers, employees, subsidiaries, affiliates, and distributors harmless against all claims, costs, damages, and expenses, and reasonable attorney fees arising out of, directly or indirectly, any claim of personal injury or death associated with such unintended or unauthorized use, even if such claim alleges that **onsemi** was negligent regarding the design or manufacture of the part. **onsemi** is an Equal Opportunity/Affirmative Action Employer. This literature is subject to all applicable copyright laws and is not for resale in any manner.

PUBLICATION ORDERING INFORMATION

LITERATURE FULFILLMENT:

Email Requests to: orderlit@onsemi.com

onsemi Website: www.onsemi.com

TECHNICAL SUPPORT

North American Technical Support:

Voice Mail: 1 800-282-9855 Toll Free USA/Canada

Phone: 011 421 33 790 2910

Europe, Middle East and Africa Technical Support:

Phone: 00421 33 790 2910

For additional information, please contact your local Sales Representative

