

# MMBTA42LT1, MMBTA43LT1

MMBTA42LT1 is a Preferred Device

## High Voltage Transistors

### NPN Silicon

#### Features

- Pb-Free Packages are Available

#### MAXIMUM RATINGS

Characteristic	Symbol	Value	Unit
Collector-Emitter Voltage MMBTA42 MMBTA43	$V_{CEO}$	300 200	Vdc
Collector-Base Voltage MMBTA42 MMBTA43	$V_{CBO}$	300 200	Vdc
Emitter-Base Voltage MMBTA42 MMBTA43	$V_{EBO}$	6.0 6.0	Vdc
Collector Current - Continuous	$I_C$	50	mAdc

#### THERMAL CHARACTERISTICS

Characteristic	Symbol	Max	Unit
Total Device Dissipation FR-5 Board (Note 1) $T_A = 25^\circ\text{C}$ Derate above $25^\circ\text{C}$	$P_D$	225 1.8	mW mW/ $^\circ\text{C}$
Thermal Resistance, Junction-to-Ambient	$R_{\theta JA}$	556	$^\circ\text{C}/\text{W}$
Total Device Dissipation Alumina Substrate (Note 2) $T_A = 25^\circ\text{C}$ Derate above $25^\circ\text{C}$	$P_D$	300 2.4	mW mW/ $^\circ\text{C}$
Thermal Resistance, Junction-to-Ambient	$R_{\theta JA}$	417	$^\circ\text{C}/\text{W}$
Junction and Storage Temperature	$T_J, T_{stg}$	-55 to +150	$^\circ\text{C}$

Stresses exceeding Maximum Ratings may damage the device. Maximum Ratings are stress ratings only. Functional operation above the Recommended Operating Conditions is not implied. Extended exposure to stresses above the Recommended Operating Conditions may affect device reliability.

- FR-5 = 1.0 x 0.75 x 0.062 in.
- Alumina = 0.4 x 0.3 x 0.024 in. 99.5% alumina.



ON Semiconductor®

<http://onsemi.com>

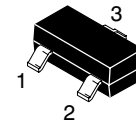
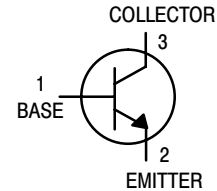

SOT-23 (TO-236)  
CASE 318  
STYLE 6

#### MARKING DIAGRAM

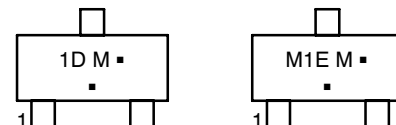

1D = MMBTA42LT  
M1E = MMBTA43LT  
M = Date Code\*  
▪ = Pb-Free Package

(Note: Microdot may be in either location)  
\*Date Code orientation and/or overbar may vary depending upon manufacturing location.

#### ORDERING INFORMATION

See detailed ordering and shipping information in the package dimensions section on page 3 of this data sheet.

Preferred devices are recommended choices for future use and best overall value.

# MMBTA42LT1, MMBTA43LT1

## ELECTRICAL CHARACTERISTICS ( $T_A = 25^\circ\text{C}$ unless otherwise noted)

Characteristic	Symbol	Min	Max	Unit	
<b>OFF CHARACTERISTICS</b>					
Collector-Emitter Breakdown Voltage (Note 3) ( $I_C = 1.0\text{ mA}$ , $I_B = 0$ )	MMBTA42 MMBTA43	$V_{(BR)CEO}$	300 200	- -	Vdc
Collector-Base Breakdown Voltage ( $I_C = 100\text{ }\mu\text{A}$ , $I_E = 0$ )	MMBTA42 MMBTA43	$V_{(BR)CBO}$	300 200	- -	Vdc
Emitter-Base Breakdown Voltage ( $I_E = 100\text{ }\mu\text{A}$ , $I_C = 0$ )		$V_{(BR)EBO}$	6.0	-	Vdc
Collector Cutoff Current ( $V_{CB} = 200\text{ Vdc}$ , $I_E = 0$ ) ( $V_{CB} = 160\text{ Vdc}$ , $I_E = 0$ )	MMBTA42 MMBTA43	$I_{CBO}$	- -	0.1 0.1	$\mu\text{A}$
Emitter Cutoff Current ( $V_{EB} = 6.0\text{ Vdc}$ , $I_C = 0$ ) ( $V_{EB} = 4.0\text{ Vdc}$ , $I_C = 0$ )	MMBTA42 MMBTA43	$I_{EBO}$	- -	0.1 0.1	$\mu\text{A}$

## ON CHARACTERISTICS (Note 3)

DC Current Gain ( $I_C = 1.0\text{ mA}$ , $V_{CE} = 10\text{ Vdc}$ ) ( $I_C = 10\text{ mA}$ , $V_{CE} = 10\text{ Vdc}$ )  ( $I_C = 30\text{ mA}$ , $V_{CE} = 10\text{ Vdc}$ )	Both Types Both Types MMBTA42 MMBTA43	$h_{FE}$	25 40 40 40	- - - -	-
Collector-Emitter Saturation Voltage ( $I_C = 20\text{ mA}$ , $I_B = 2.0\text{ mA}$ )	MMBTA42 MMBTA43	$V_{CE(sat)}$	- -	0.5 0.5	Vdc
Base-Emitter Saturation Voltage ( $I_C = 20\text{ mA}$ , $I_B = 2.0\text{ mA}$ )		$V_{BE(sat)}$	-	0.9	Vdc

## SMALL-SIGNAL CHARACTERISTICS

Current-Gain - Bandwidth Product ( $I_C = 10\text{ mA}$ , $V_{CE} = 20\text{ Vdc}$ , $f = 100\text{ MHz}$ )		$f_T$	50	-	MHz
Collector-Base Capacitance ( $V_{CB} = 20\text{ Vdc}$ , $I_E = 0$ , $f = 1.0\text{ MHz}$ )	MMBTA42 MMBTA43	$C_{cb}$	- -	3.0 4.0	pF

3. Pulse Test: Pulse Width  $\leq 300\text{ }\mu\text{s}$ , Duty Cycle  $\leq 2.0\%$ .

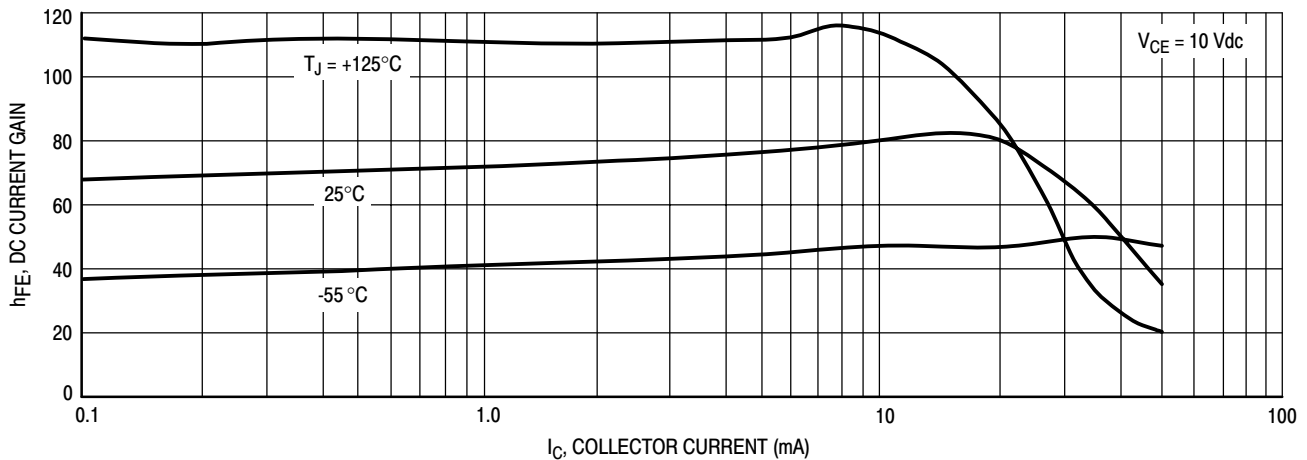

Figure 1. DC Current Gain

# MMBTA42LT1, MMBTA43LT1

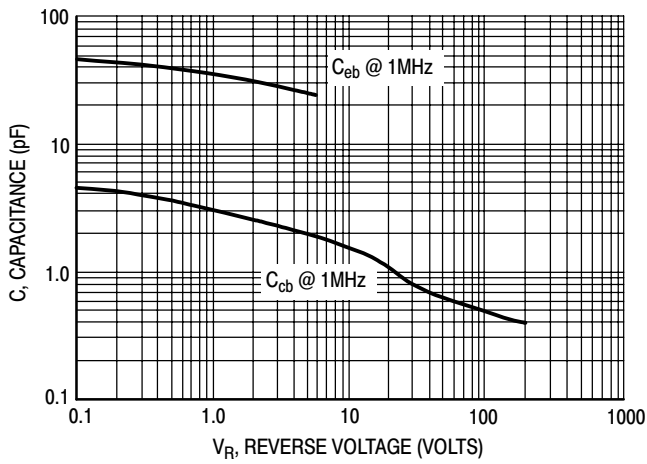

Figure 2. Capacitance

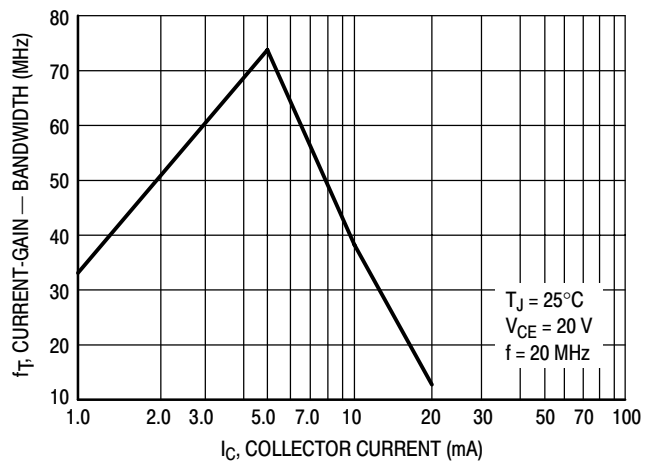

Figure 3. Current-Gain - Bandwidth

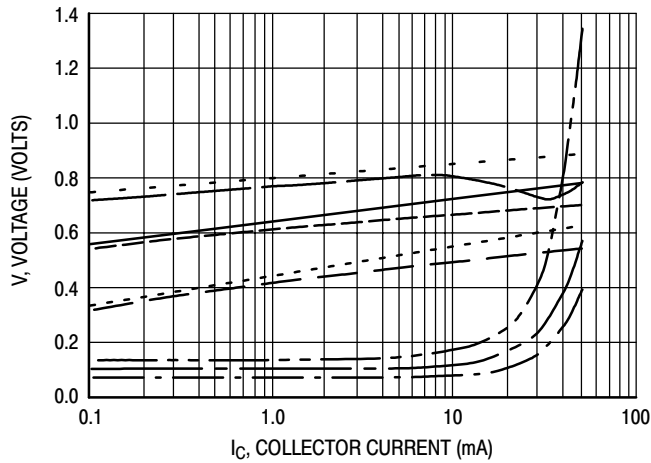

Figure 4. "ON" Voltages

- $V_{CE(sat)}$  @ 25°C,  $I_C/I_B = 10$
- $V_{CE(sat)}$  @ 125°C,  $I_C/I_B = 10$
- $V_{CE(sat)}$  @ -55°C,  $I_C/I_B = 10$
- $V_{BE(sat)}$  @ 25°C,  $I_C/I_B = 10$
- $V_{BE(sat)}$  @ 125°C,  $I_C/I_B = 10$
- $V_{BE(sat)}$  @ -55°C,  $I_C/I_B = 10$
- $V_{BE(on)}$  @ 25°C,  $V_{CE} = 10 V$
- $V_{BE(on)}$  @ 125°C,  $V_{CE} = 10 V$
- $V_{BE(on)}$  @ -55°C,  $V_{CE} = 10 V$

## ORDERING INFORMATION

Device Order Number	Package Type	Shipping†
MMBTA42LT1	SOT-23	3,000 / Tape & Reel
MMBTA42LT1G	SOT-23 (Pb-Free)	3,000 / Tape & Reel
MMBTA42LT3	SOT-23	10,000 / Tape & Reel
MMBTA42LT3G	SOT-23 (Pb-Free)	10,000 / Tape & Reel
MMBTA43LT1	SOT-23	3,000 / Tape & Reel
MMBTA43LT1G	SOT-23 (Pb-Free)	3,000 / Tape & Reel

†For information on tape and reel specifications, including part orientation and tape sizes, please refer to our Tape and Reel Packaging Specifications Brochure, BRD8011/D.

# MMBTA42LT1, MMBTA43LT1

## PACKAGE DIMENSIONS

SOT-23 (TO-236)  
CASE 318-08  
ISSUE AN

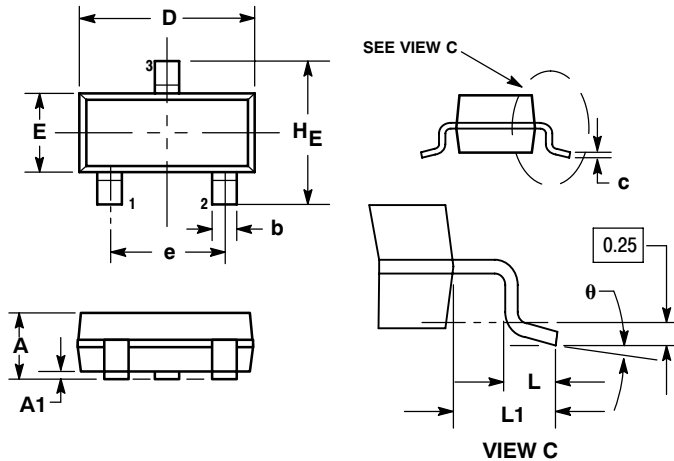

### NOTES:

1. DIMENSIONING AND TOLERANCING PER ANSI Y14.5M, 1982.
2. CONTROLLING DIMENSION: INCH.
3. MAXIMUM LEAD THICKNESS INCLUDES LEAD FINISH THICKNESS. MINIMUM LEAD THICKNESS IS THE MINIMUM THICKNESS OF BASE MATERIAL.
4. 318-01 THRU -07 AND -09 OBSOLETE, NEW STANDARD 318-08.

DIM	MILLIMETERS			INCHES		
	MIN	NOM	MAX	MIN	NOM	MAX
A	0.89	1.00	1.11	0.035	0.040	0.044
A1	0.01	0.06	0.10	0.001	0.002	0.004
b	0.37	0.44	0.50	0.015	0.018	0.020
c	0.09	0.13	0.18	0.003	0.005	0.007
D	2.80	2.90	3.04	0.110	0.114	0.120
E	1.20	1.30	1.40	0.047	0.051	0.055
e	1.78	1.90	2.04	0.070	0.075	0.081
L	0.10	0.20	0.30	0.004	0.008	0.012
L1	0.35	0.54	0.69	0.014	0.021	0.029
HE	2.10	2.40	2.64	0.083	0.094	0.104

### STYLE 6:

1. BASE
2. EMITTER
3. COLLECTOR

### SOLDERING FOOTPRINT\*

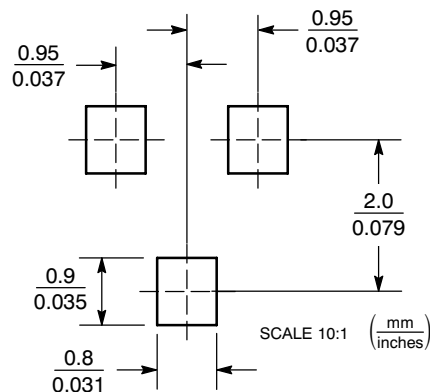

\*For additional information on our Pb-Free strategy and soldering details, please download the ON Semiconductor Soldering and Mounting Techniques Reference Manual, SOLDERRM/D.

ON Semiconductor and are registered trademarks of Semiconductor Components Industries, LLC (SCILLC). SCILLC reserves the right to make changes without further notice to any products herein. SCILLC makes no warranty, representation or guarantee regarding the suitability of its products for any particular purpose, nor does SCILLC assume any liability arising out of the application or use of any product or circuit, and specifically disclaims any and all liability, including without limitation special, consequential or incidental damages. "Typical" parameters which may be provided in SCILLC data sheets and/or specifications can and do vary in different applications and actual performance may vary over time. All operating parameters, including "Typicals" must be validated for each customer application by customer's technical experts. SCILLC does not convey any license under its patent rights nor the rights of others. SCILLC products are not designed, intended, or authorized for use as components in systems intended for surgical implant into the body, or other applications intended to support or sustain life, or for any other application in which the failure of the SCILLC product could create a situation where personal injury or death may occur. Should Buyer purchase or use SCILLC products for any such unintended or unauthorized application, Buyer shall indemnify and hold SCILLC and its officers, employees, subsidiaries, affiliates, and distributors harmless against all claims, costs, damages, and expenses, and reasonable attorney fees arising out of, directly or indirectly, any claim of personal injury or death associated with such unintended or unauthorized use, even if such claim alleges that SCILLC was negligent regarding the design or manufacture of the part. SCILLC is an Equal Opportunity/Affirmative Action Employer. This literature is subject to all applicable copyright laws and is not for resale in any manner.

### PUBLICATION ORDERING INFORMATION

**LITERATURE FULFILLMENT:**  
Literature Distribution Center for ON Semiconductor  
P.O. Box 5163, Denver, Colorado 80217 USA  
**Phone:** 303-675-2175 or 800-344-3860 Toll Free USA/Canada  
**Fax:** 303-675-2176 or 800-344-3867 Toll Free USA/Canada  
**Email:** orderlit@onsemi.com

**N. American Technical Support:** 800-282-9855 Toll Free  
USA/Canada  
**Europe, Middle East and Africa Technical Support:**  
Phone: 421 33 790 2910  
**Japan Customer Focus Center**  
Phone: 81-3-5773-3850

**ON Semiconductor Website:** [www.onsemi.com](http://www.onsemi.com)  
**Order Literature:** <http://www.onsemi.com/orderlit>

For additional information, please contact your local Sales Representative

MMBTA42LT1/D