

## Turbo 2 ultrafast high voltage rectifier

Datasheet - production data

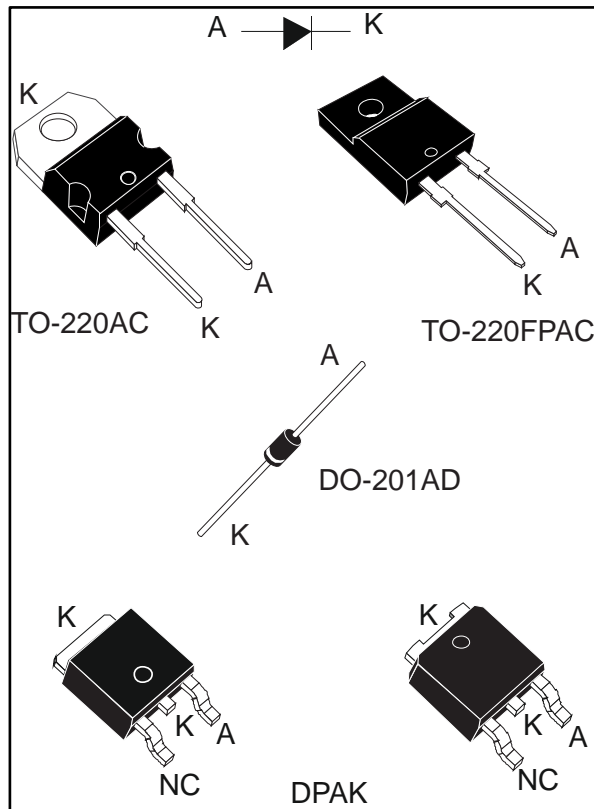

### Description

The device is developed using ST's Turbo 2 600 V technology. It is well-suited as a boost diode, especially for use in continuous mode power factor corrections and hard switching conditions.

This device is also intended for use as a free wheeling diode in power supplies and other power switching applications.

**Table 1: Device summary**

Symbol	Value
$I_{F(AV)}$	5 A
$V_{RRM}$	600 V
$I_R$ (max)	125 $\mu$ A / 150 $\mu$ A
$T_j$ (max)	175 °C
$V_F$ (typ)	0.85 V
$t_{rr}$ (typ)	65 ns

### Features

- Ultrafast switching
- Low reverse recovery current
- Reduces switching losses
- Low thermal resistance
- Insulated package: TO-220FPAC
  - Insulation voltage: 2000  $V_{RMS}$  sine
- ECOPACK<sup>®</sup>2 compliant component for DPAK on demand

# 1 Characteristics

**Table 2: Absolute ratings (limiting values at 25 °C, unless otherwise specified)**

Symbol	Parameter		Value	Unit	
V <sub>RRM</sub>	Repetitive peak reverse voltage		600	V	
I <sub>F(RMS)</sub>	Forward rms current	TO-220AC TO-220FPAC DO-201AD	20	A	
		DPAK	10		
I <sub>F(AV)</sub>	Average forward current $\delta = 0.5$ , square wave	TO-220AC, DPAK	T <sub>C</sub> = 150 °C	A	
		DO-201AD	T <sub>I</sub> = 50 °C		
		TO-220FPAC	T <sub>C</sub> = 135 °C		
I <sub>FRM</sub>	Repetitive peak forward current	t <sub>p</sub> = 5 $\mu$ s, F = 5 kHz square	65	A	
I <sub>FSM</sub>	Surge non repetitive forward current	t <sub>p</sub> = 10 ms sinusoidal	TO-220AC TO-220FPAC	90	A
			DO-201AD	110	
			DPAK	60	
T <sub>stg</sub>	Storage temperature range		-65 to +175	°C	
T <sub>j</sub>	Maximum operating junction temperature		175	°C	

**Table 3: Thermal parameter**

Symbol	Parameter		Max. value	Unit
R <sub>th(j-c)</sub>	Junction to case	TO-220AC / DPAK	3.5	°C/W
		TO-220FPAC	6	
R <sub>th(j-l)</sub>	Junction to lead	L = 10 mm, DO-201AD	20	°C/W
R <sub>th(j-a)</sub>	Junction to ambient		75	

Table 4: Static electrical characteristics

Symbol	Parameter	Test conditions		Min.	Typ.	Max.	Unit
$I_R^{(1)}$	Reverse leakage current	$T_j = 25\text{ °C}$	$V_R = 600\text{ V}$	-		5	$\mu\text{A}$
		$T_j = 150\text{ °C}$	$V_R = 600\text{ V}$		10	125	
				TO-220AC TO-220FPAC DPAK DO-201AD	-	25	
$V_F^{(2)}$	Forward voltage drop	$T_j = 25\text{ °C}$	$I_F = 5\text{ A}$	-		1.30	V
		$T_j = 150\text{ °C}$		-	0.85	1.05	

**Notes:**(1)Pulse test:  $t_p = 5\text{ ms}$ ,  $\delta < 2\%$ (2)Pulse test:  $t_p = 380\text{ }\mu\text{s}$ ,  $\delta < 2\%$ 

To evaluate the conduction losses, use the following equation:

$$P = 0.89 \times I_{F(AV)} + 0.033 \times I_F^2(RMS)$$

Table 5: Dynamic electrical characteristics

Symbol	Parameter	Test conditions		Min.	Typ.	Max.	Unit
$t_{rr}$	Reverse recovery time	$T_j = 25\text{ °C}$	$I_F = 1\text{ A}$ $V_R = 30\text{ V}$ $dI_F/dt = -50\text{ A}/\mu\text{s}$	-	65	95	ns
$t_{fr}$	Forward recovery time	$T_j = 25\text{ °C}$	$I_F = 5\text{ A}$ $V_{FR} = 1.1 \times V_{Fmax}$ $dI_F/dt = 100\text{ A}/\mu\text{s}$	-		150	ns
$V_{FP}$	Forward recovery voltage		$I_F = 5\text{ A}$ $dI_F/dt = 100\text{ A}/\mu\text{s}$	-		7	V

# 1.1 Characteristics (curves)

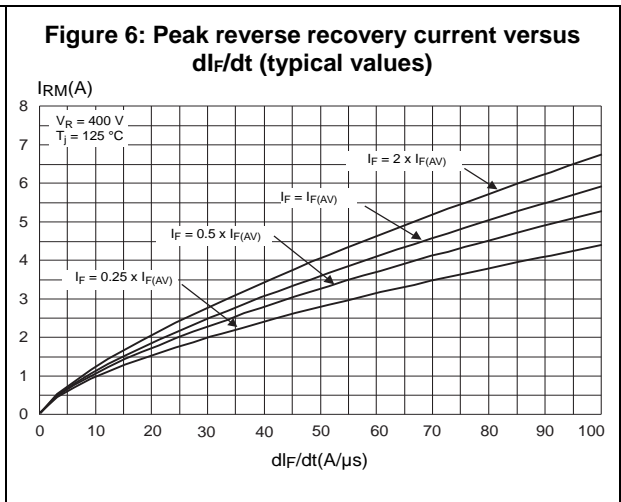
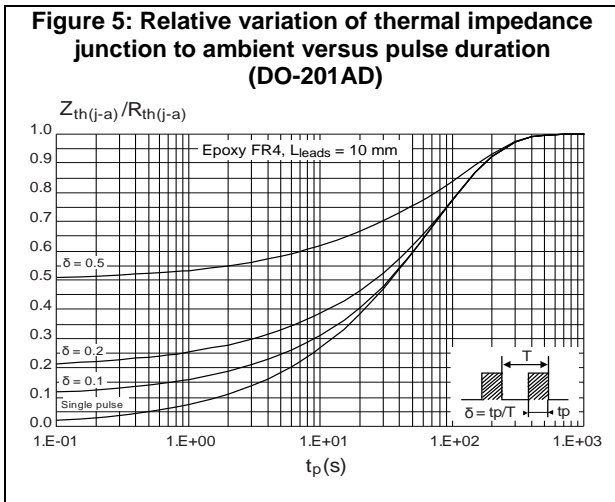
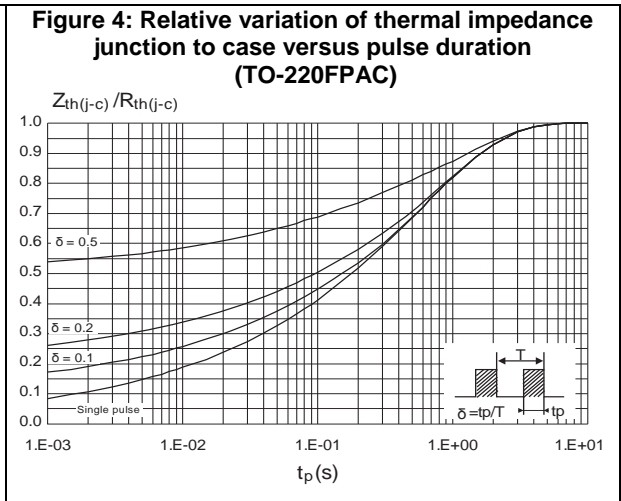
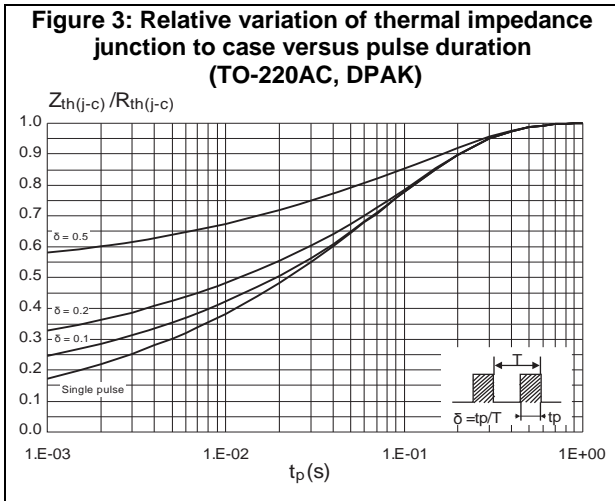
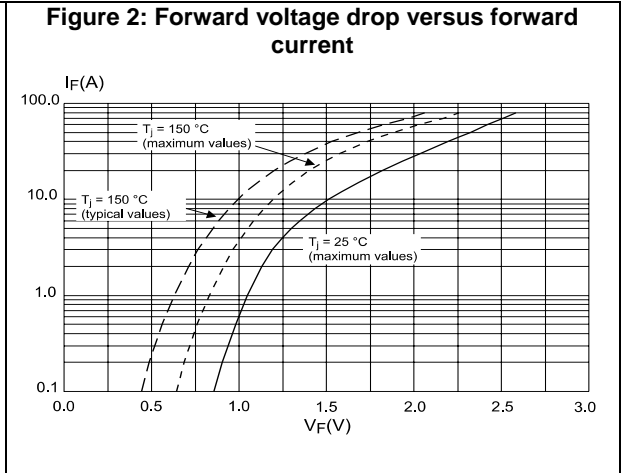
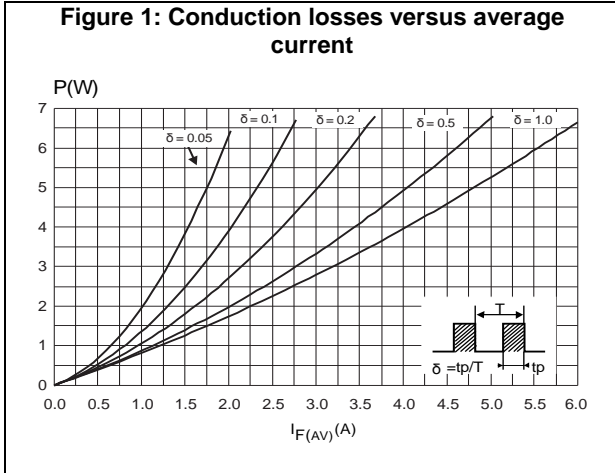

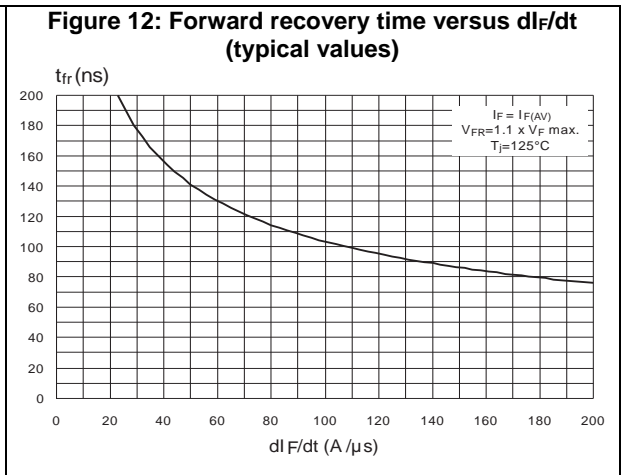
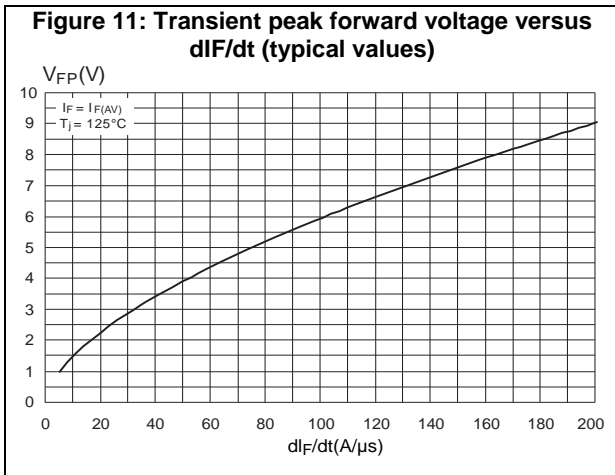
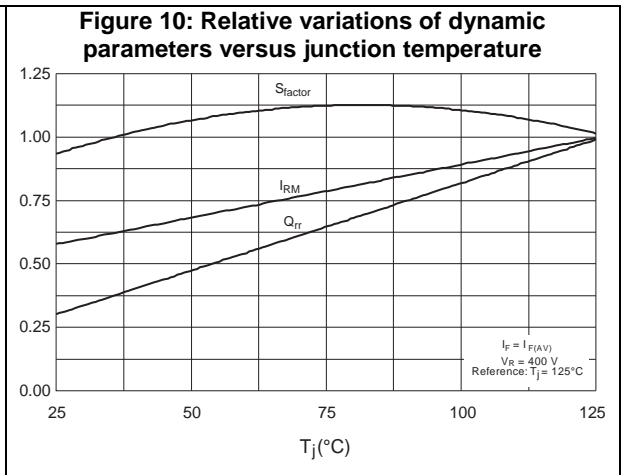
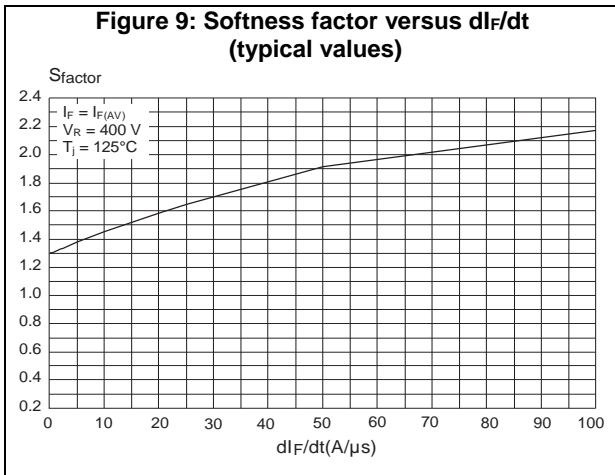
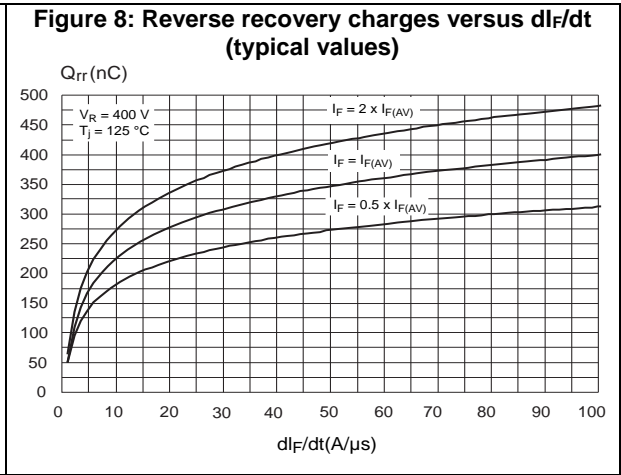
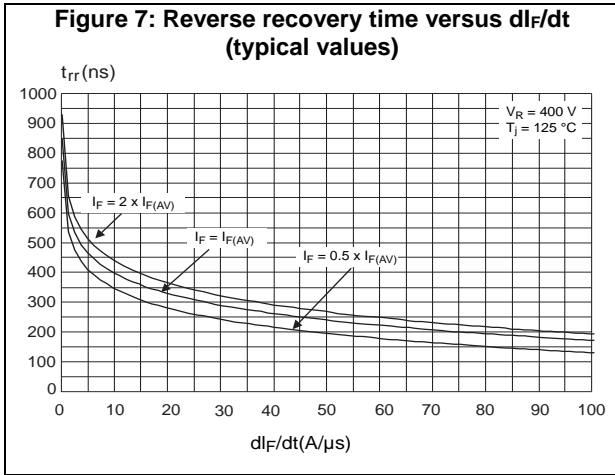

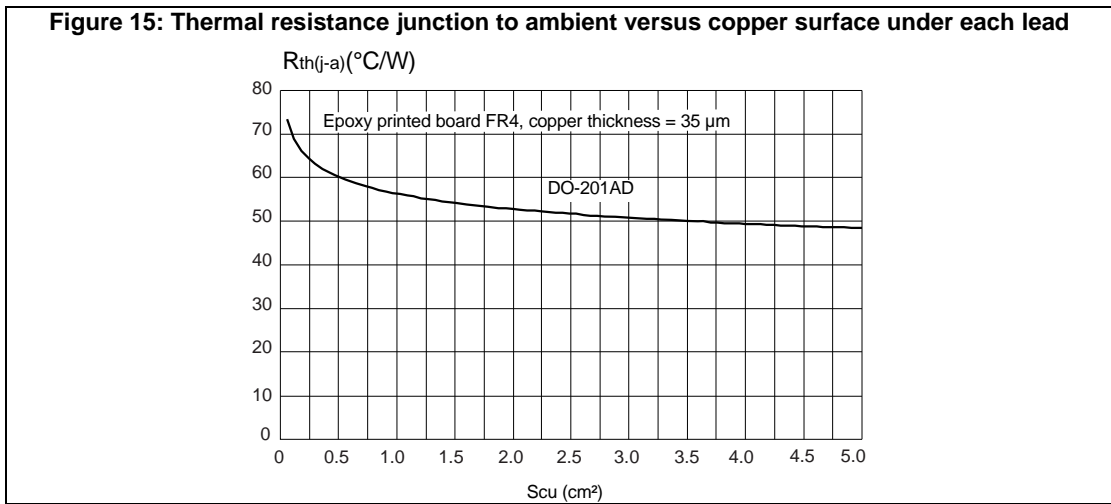
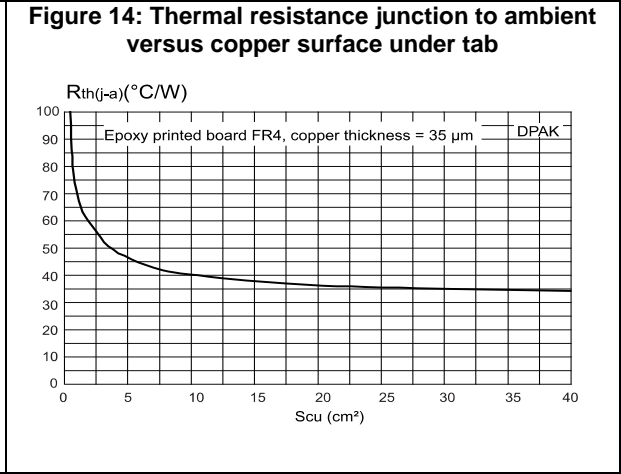
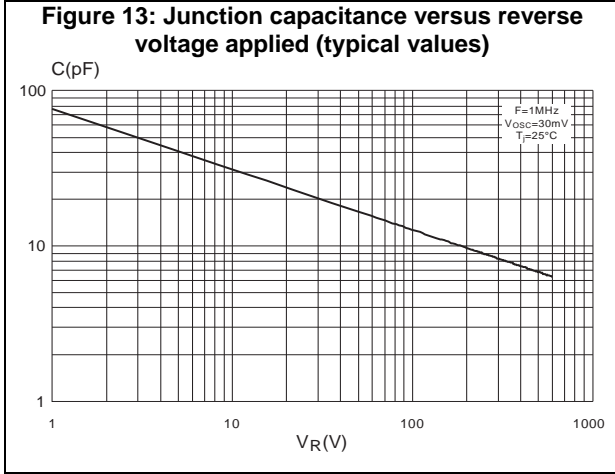

## 2 Package information

In order to meet environmental requirements, ST offers these devices in different grades of ECOPACK® packages, depending on their level of environmental compliance. ECOPACK® specifications, grade definitions and product status are available at: [www.st.com](http://www.st.com). ECOPACK® is an ST trademark.

- Cooling method: by conduction (C)
- Epoxy meets UL 94,V0
- Recommended torque value: 0.55 N·m (for TO-220FPAC / TO-220AC)
- Maximum torque value: 0.7 N·m (for TO-220FPAC / TO-220AC)

### 2.1 TO-220AC package information

Figure 16: TO-220AC package outline

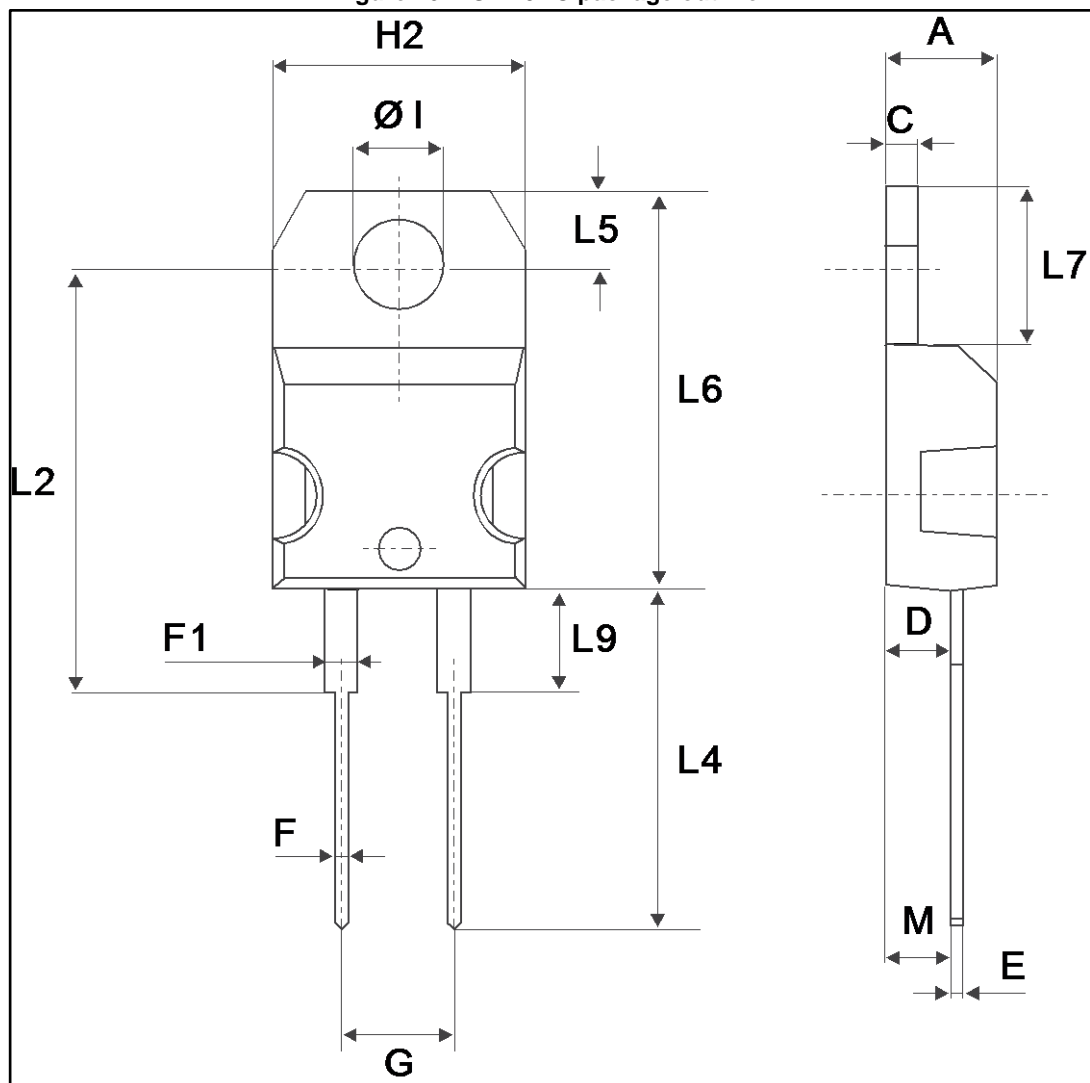

Table 6: TO-220AC package mechanical data

Ref.	Dimensions			
	Millimeters		Inches	
	Min.	Max.	Min.	Max.
A	4.40	4.60	0.173	0.181
C	1.23	1.32	0.048	0.051
D	2.40	2.72	0.094	0.107
E	0.49	0.70	0.019	0.027
F	0.61	0.88	0.024	0.034
F1	1.14	1.70	0.044	0.066
G	4.95	5.15	0.194	0.202
H2	10.00	10.40	0.393	0.409
L2	16.40 typ.		0.645 typ.	
L4	13.00	14.00	0.511	0.551
L5	2.65	2.95	0.104	0.116
L6	15.25	15.75	0.600	0.620
L7	6.20	6.60	0.244	0.259
L9	3.50	3.93	0.137	0.154
M	2.6 typ.		0.102 typ.	
ØI	3.75	3.85	0.147	0.151



## 2.2 TO-220FPAC package information

Figure 17: TO-220FPAC package outline

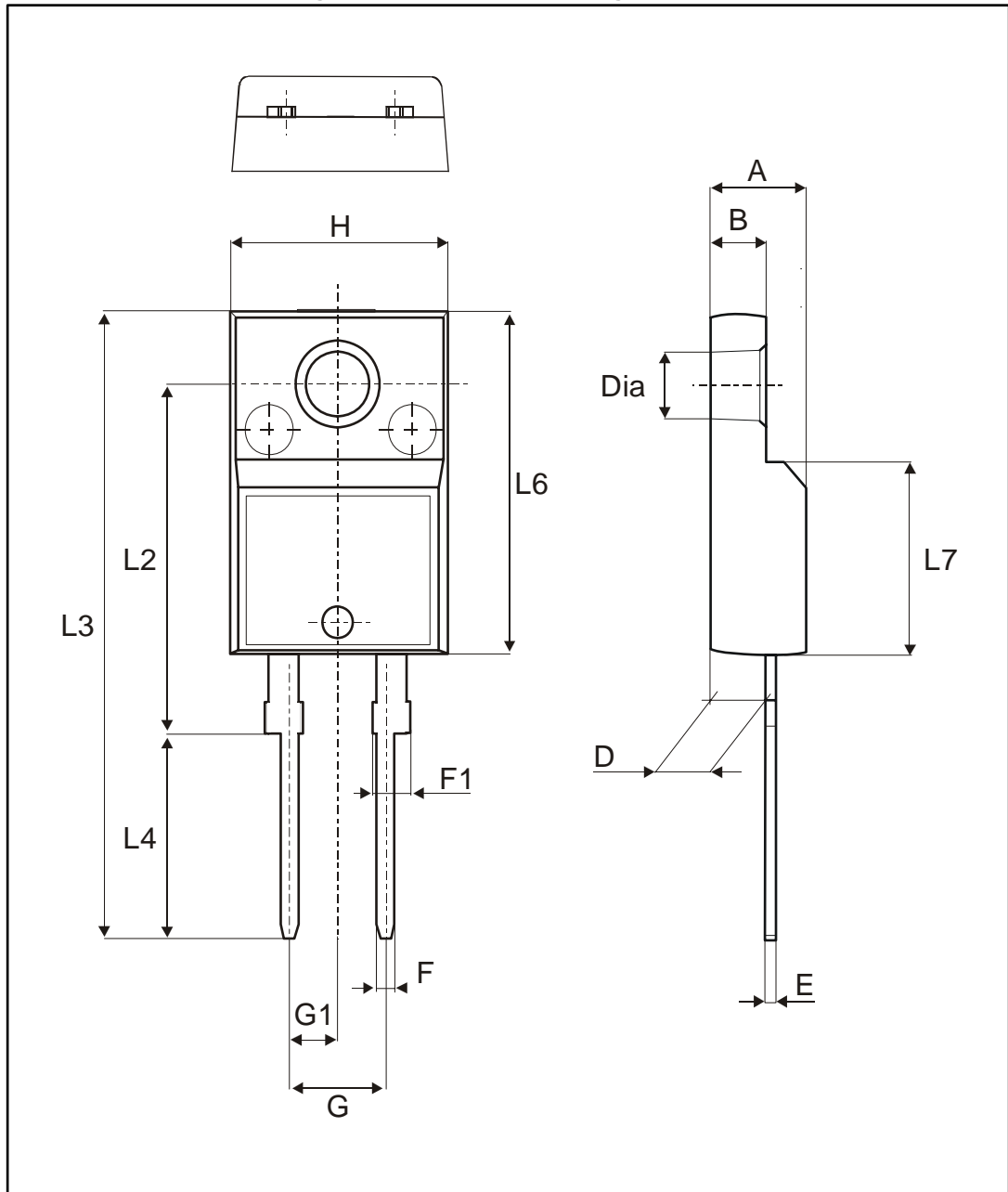

Table 7: TO-220FPAC package mechanical data

Ref.	Dimensions			
	Millimeters		Inches	
	Min.	Max.	Min.	Max.
A	4.40	4.60	0.173	0.181
B	2.50	2.70	0.098	0.106
D	2.50	2.75	0.098	0.108
E	0.45	0.70	0.018	0.027
F	0.75	1.00	0.030	0.039
F1	1.15	1.70	0.045	0.067
G	4.95	5.20	0.195	0.205
G1	2.40	2.70	0.094	0.106
H	10.00	10.40	0.393	0.409
L2	16.00 typ.		0.630 typ.	
L3	28.60	30.60	0.126	1.205
L4	9.80	10.60	0.386	0.417
L6	15.90	16.40	0.626	0.646
L7	9.00	9.30	0.354	0.366
Dia.	3.00	3.20	0.118	0.126

## 2.3 DO-201AD package information

Figure 18: DO-201AD package outline

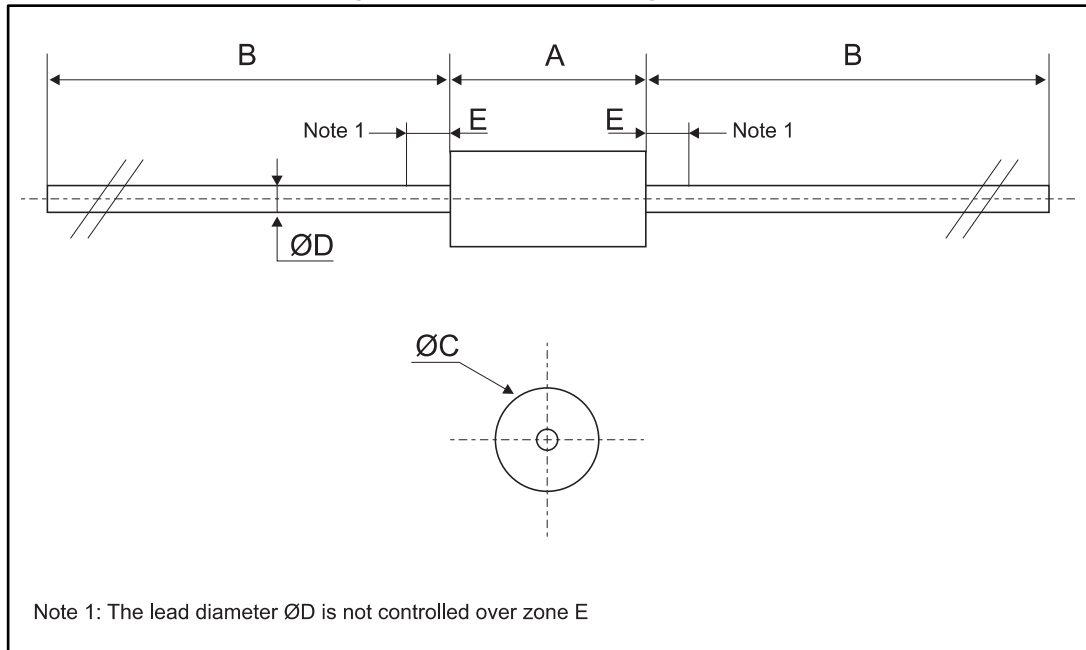
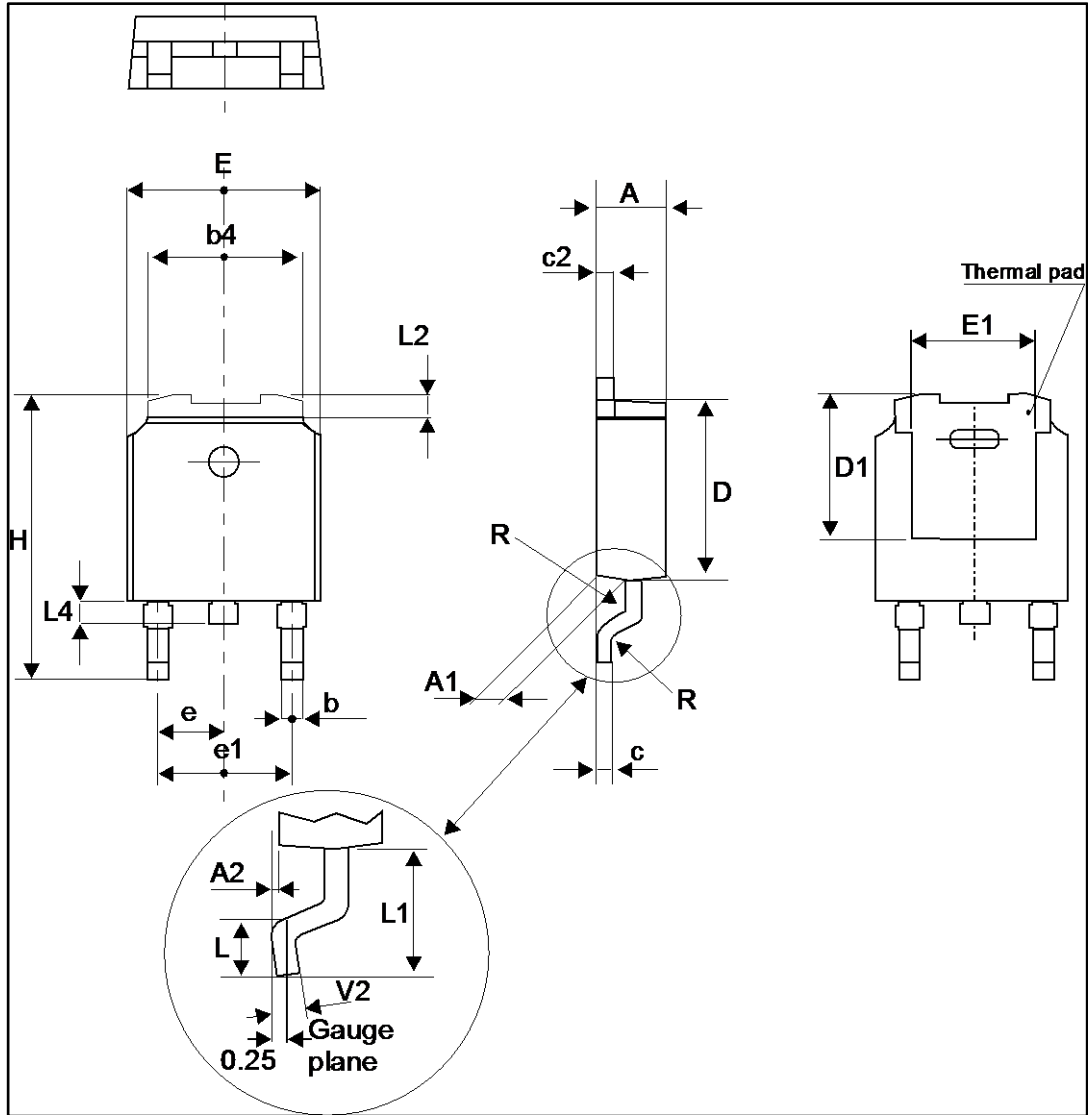

Table 8: DO-201AD package mechanical data

Ref.	Dimensions			
	Millimeters		Inches	
	Min.	Max.	Min.	Max.
A		9.50		0.374
B	25.40		1.000	
$\varnothing C$		5.30		0.209
$\varnothing D$		1.30		0.051
E		1.25		0.049

## 2.4 DPAK package information

Figure 19: DPAK package outline



This package drawing may slightly differ from the physical package. However, all the specified dimensions are guaranteed.

Table 9: DPAK package mechanical data

Ref.	Dimensions			
	Millimeters		Inches	
	Min.	Max.	Min.	Max.
A	2.18	2.40	0.085	0.094
A1	0.90	1.10	0.035	0.043
A2	0.03	0.23	0.001	0.009
b	0.64	0.90	0.025	0.035
b4	4.95	5.46	0.194	0.215
c	0.46	0.61	0.018	0.024
c2	0.46	0.60	0.018	0.023
D	5.97	6.22	0.235	0.244
D1	4.95	5.60	0.194	0.220
E	6.35	6.73	0.250	0.265
E1	4.32	5.50	0.170	0.216
e	2.286 typ.		0.090 typ.	
e1	4.40	4.70	0.173	0.185
H	9.35	10.40	0.368	0.409
L	1.0	1.78	0.039	0.070
L2		1.27		0.050
L4	0.60	1.02	0.023	0.040
V2	-8°	+8°	-8°	+8°

Figure 20: DPAK recommended footprint (dimensions in mm)

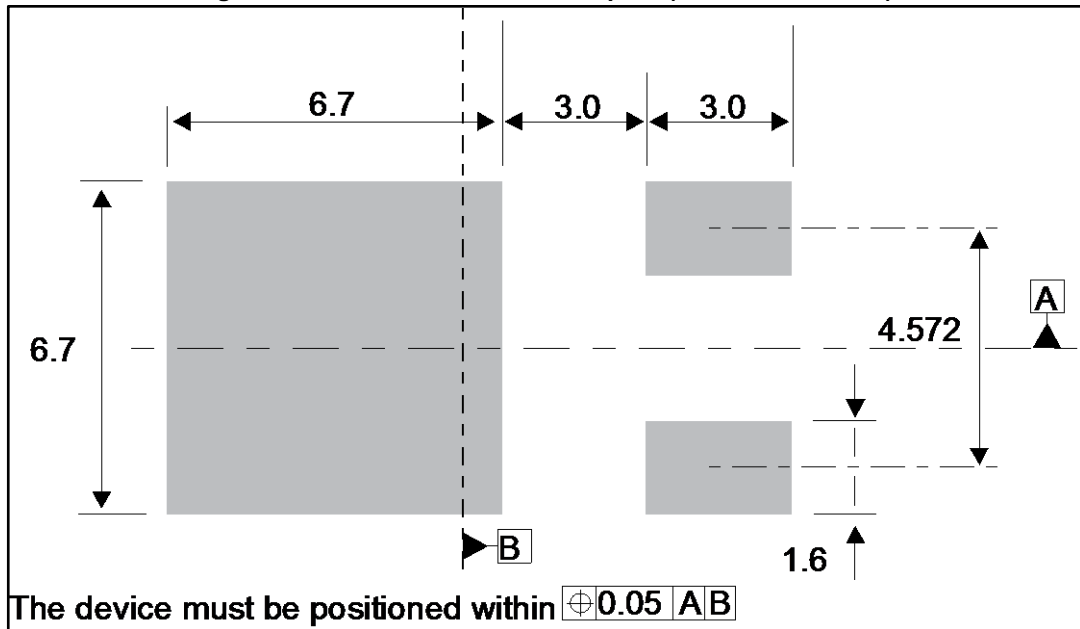

### 3 Ordering information

Table 10: Ordering information

Order code	Marking	Package	Weight	Base qty	Delivery mode
STTH5L06	STTH5L06	DO-201AD	1.12 g	600	Ammopack
STTH5L06RL	STTH5L06			1900	Tape and reel
STTH5L06D	STTH5L06D	TO-220AC	1.9 g	50	Tube
STTH5L06B-TR	STTH5 L06B	DPAK	0.32 g	2500	Tape and reel
STTH5L06FP	STTH5L06FP	TO-220FPAC	1.9 g	50	Tube

### 4 Revision history

Table 11: Document revision history

Date	Revision	Changes
16-Nov-2001	1	First issue.
31-Mar-2007	2	Merged with TO-220AC, TO-220FPAC and DPAK version.
26-Nov-2014	3	Updated DPAK and reformatted to current standard.
05-Dec-2014	4	Updated Features.
17-May-2017	5	Updated DPAK package information and reformatted to current standard.

**IMPORTANT NOTICE – PLEASE READ CAREFULLY**

STMicroelectronics NV and its subsidiaries ("ST") reserve the right to make changes, corrections, enhancements, modifications, and improvements to ST products and/or to this document at any time without notice. Purchasers should obtain the latest relevant information on ST products before placing orders. ST products are sold pursuant to ST's terms and conditions of sale in place at the time of order acknowledgement.

Purchasers are solely responsible for the choice, selection, and use of ST products and ST assumes no liability for application assistance or the design of Purchasers' products.

No license, express or implied, to any intellectual property right is granted by ST herein.

Resale of ST products with provisions different from the information set forth herein shall void any warranty granted by ST for such product.

ST and the ST logo are trademarks of ST. All other product or service names are the property of their respective owners.

Information in this document supersedes and replaces information previously supplied in any prior versions of this document.

© 2017 STMicroelectronics – All rights reserved