

EMH2407

EMH2407 General-Purpose Switching Device Applications

Features

- Low ON-Resistance
- Best Suited for LiB Charging and Discharging Switch
- Common-Drain Type
- 2.5 V Drive
- Protection Diode In

ABSOLUTE MAXIMUM RATINGS at Ta = 25°C

Symbol	Parameter	Conditions	Ratings	Unit
V _{DSS}	Drain to Source Voltage		20	V
V _{GSS}	Gate to Source Voltage		±12	V
I _D	Drain Current (DC)		6	A
I _{DP}	Drain Current (Pulse)	PW ≤ 10 μs, duty cycles ≤ 1%	40	A
P _D	Allowable Power Dissipation	When mounted on ceramic substrate (900 mm ² × 0.8 mm) 1 unit	1.3	W
P _T	Total Dissipation	When mounted on ceramic substrate (900 mm ² × 0.8 mm)	1.4	W
T _{CH}	Channel Temperature		150	°C
T _{STG}	Storage Temperature		-55 to +150	°C

Stresses exceeding those listed in the Maximum Ratings table may damage the device. If any of these limits are exceeded, device functionality should not be assumed, damage may occur and reliability may be affected.



ON Semiconductor®

www.onsemi.com

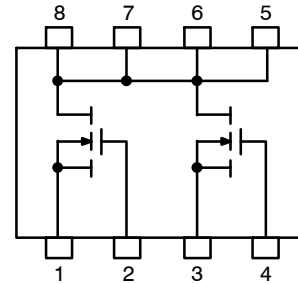

ELECTRICAL CONNECTION

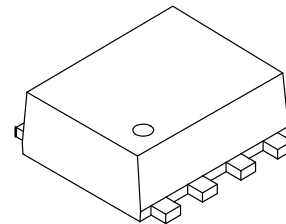

EMH8
CASE 419AT

MARKING DIAGRAM

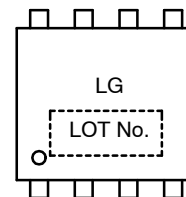

LG = Specific Device Code
XX = Lot Number

ORDERING INFORMATION

Device	Package	Memo	Shipping
EMH2407-TL-H	EMH8	Pb-Free/ Halogen Free	3000 Units/ Reel

EMH2407

ELECTRICAL CHARACTERISTICS at Ta = 25°C

Symbol	Parameter	Conditions	Min	Typ	Max	Unit
$V_{(BR)DSS}$	Drain to Source Breakdown Voltage	$I_D = 1 \text{ mA}, V_{GS} = 0 \text{ V}$	20			V
I_{DSS}	Zero Gate Voltage Drain Current	$V_{DS} = 20 \text{ V}, V_{GS} = 0 \text{ V}$			1	μA
I_{GSS}	Gate to Source Leakage Current	$V_{GS} = \pm 8 \text{ V}, V_{DS} = 0 \text{ V}$			± 10	μA
$V_{GS(off)}$	Cutoff Voltage	$V_{DS} = 10 \text{ V}, I_D = 1 \text{ mA}$	0.5		1.3	V
$ y_{fs} $	Forward Transfer Admittance	$V_{DS} = 10 \text{ V}, I_D = 3 \text{ A}$	3	5		S
$R_{DS(on)1}$	Static Drain to Source On-State Resistance	$I_D = 3 \text{ A}, V_{GS} = 4.5 \text{ V}$	13	19	25	$\text{m}\Omega$
$R_{DS(on)2}$		$I_D = 3 \text{ A}, V_{GS} = 4 \text{ V}$	14	20	26	$\text{m}\Omega$
$R_{DS(on)3}$		$I_D = 1.5 \text{ A}, V_{GS} = 2.5 \text{ V}$	16	28	39	$\text{m}\Omega$
C_{iss}	Input Capacitance	$V_{DS} = 10 \text{ V}, f = 1 \text{ MHz}$		580		pF
C_{oss}	Output Capacitance			95		pF
C_{rss}	Reverse Transfer Capacitance			75		pF
$t_d(on)$	Turn-ON Delay Time	See specified Test Circuit.		310		ns
t_r	Rise Time			1020		ns
$t_d(off)$	Turn-OFF Delay Time			3000		ns
t_f	Fall Time			2250		ns
Q_g	Total Gate Charge	$V_{DS} = 10 \text{ V}, V_{GS} = 4.5 \text{ V}, I_D = 6 \text{ A}$		6.3		nC
Q_{gs}	Gate to Source Charge			0.83		nC
Q_{gd}	Gate to Drain "Miller" Charge			1.9		nC
V_{SD}	Diode Forward Voltage		$I_S = 6 \text{ A}, V_{GS} = 0 \text{ V}$		0.78	

Product parametric performance is indicated in the Electrical Characteristics for the listed test conditions, unless otherwise noted. Product performance may not be indicated by the Electrical Characteristics if operated under different conditions.

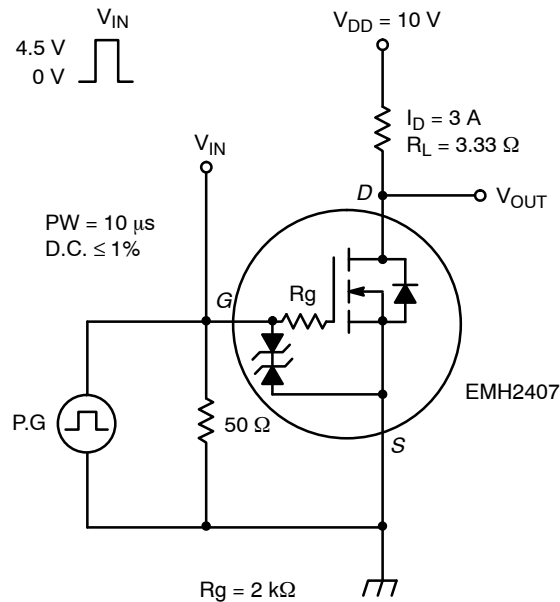

Figure 1. Switching Time Test Circuit

TYPICAL CHARACTERISTICS

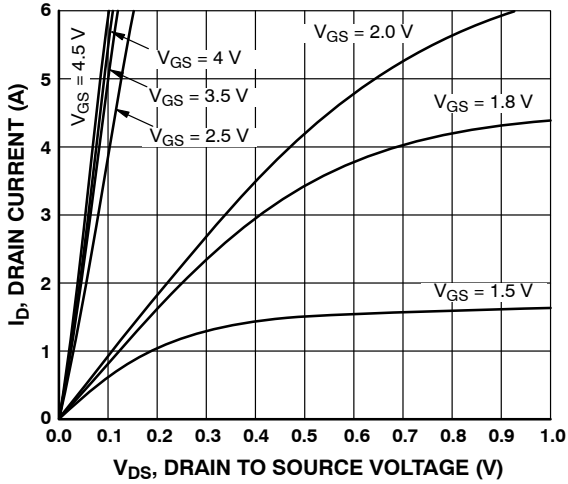

Figure 2. $I_D - V_{DS}$

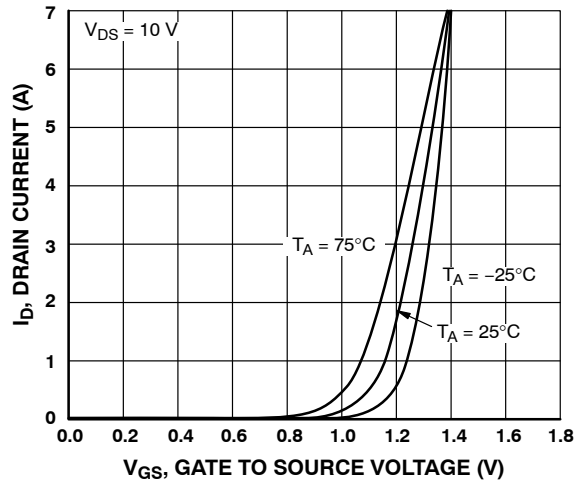

Figure 3. $I_D - V_{GS}$

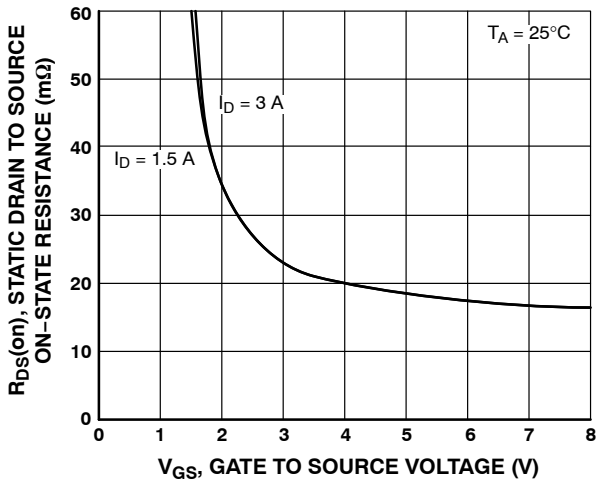

Figure 4. $R_{DS(on)} - V_{GS}$

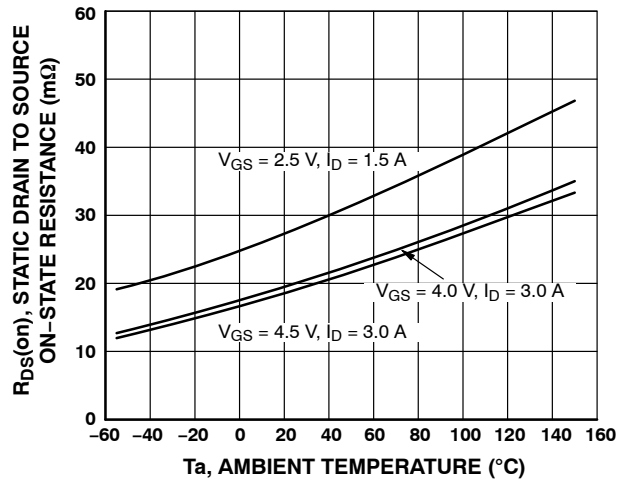

Figure 5. $R_{DS(on)} - T_a$

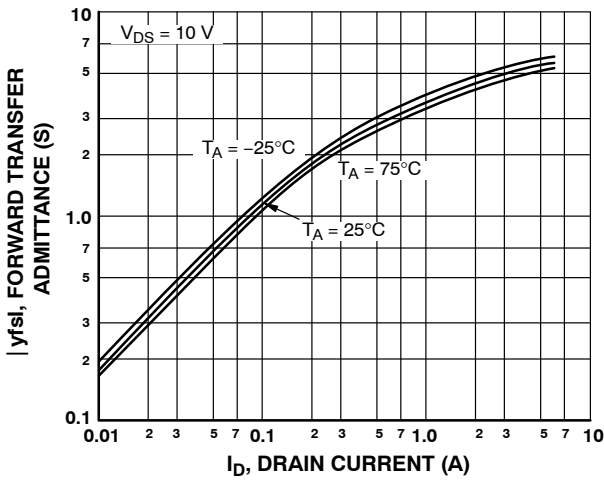

Figure 6. $|y_{fs}| - I_D$

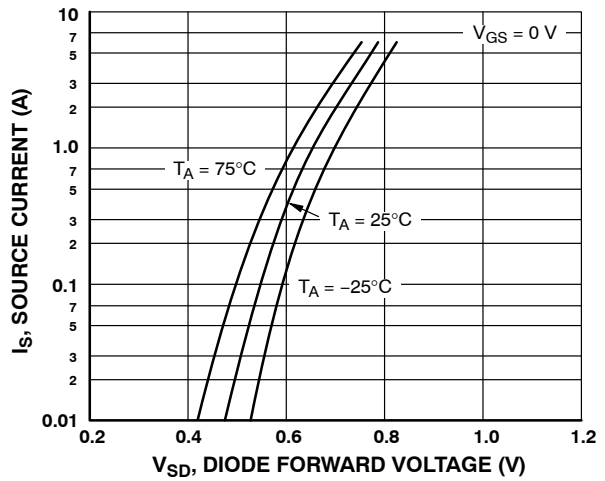

Figure 7. $I_S - V_{SD}$

TYPICAL CHARACTERISTICS (continued)

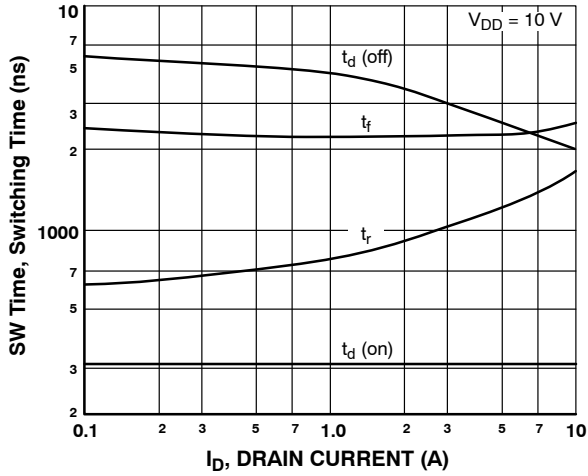

Figure 8. SW Time - I_D

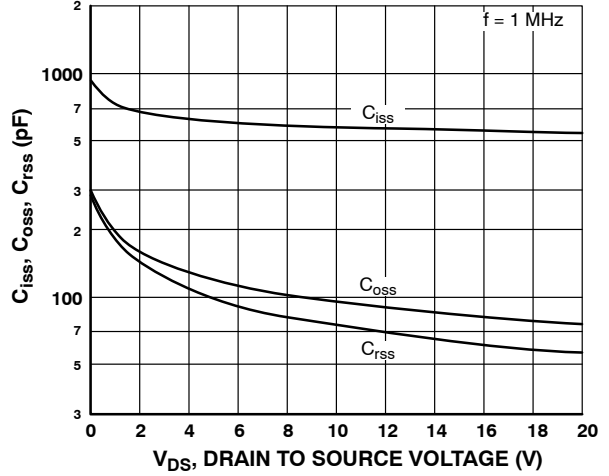

Figure 9. C_{iss} , C_{oss} , C_{rss} - V_{DS}

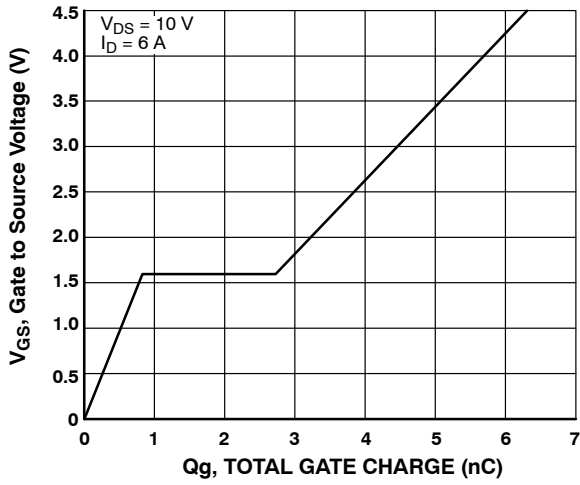

Figure 10. V_{GS} - Q_g

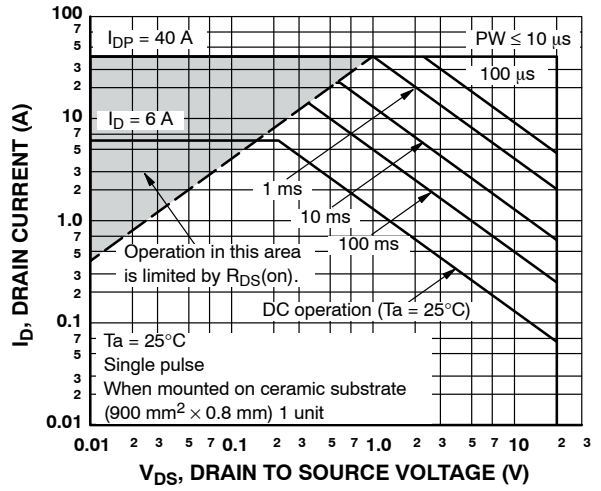

Figure 11. ASO

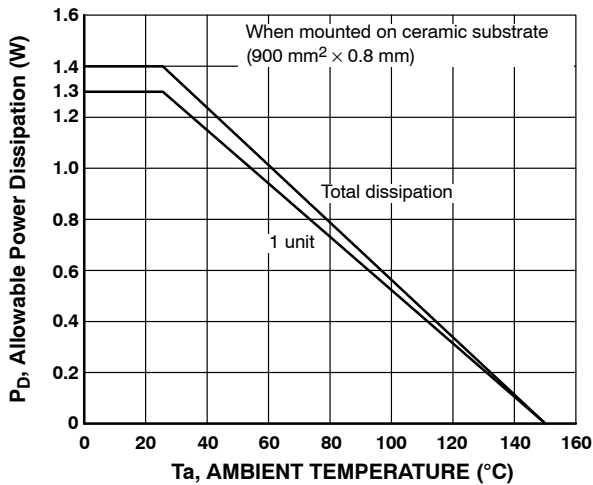
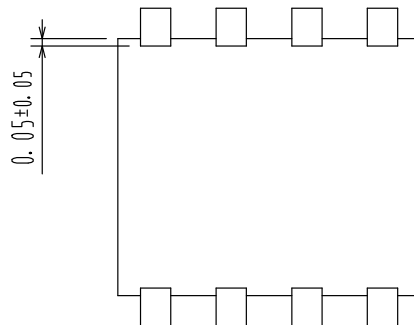
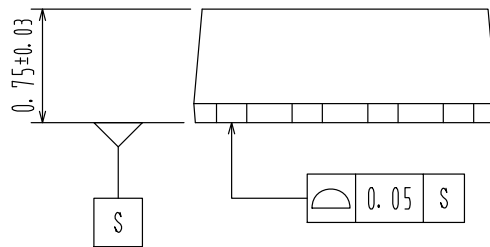
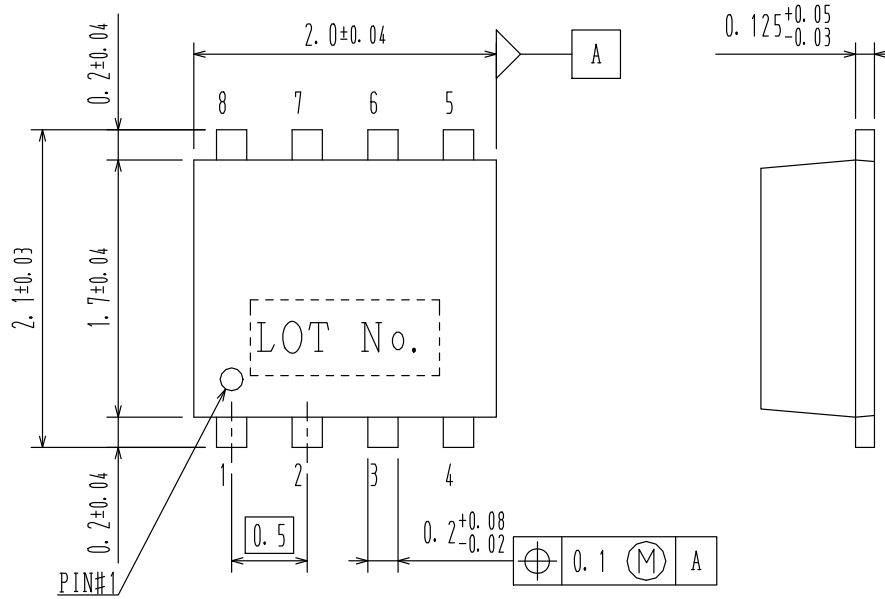



Figure 12. P_D - T_a

EMH2407

PACKAGE DIMENSIONS

SOT-383FL / EMH8
CASE 419AT
ISSUE O



ON Semiconductor and  are trademarks of Semiconductor Components Industries, LLC dba ON Semiconductor or its subsidiaries in the United States and/or other countries. ON Semiconductor owns the rights to a number of patents, trademarks, copyrights, trade secrets, and other intellectual property. A listing of ON Semiconductor's product/patent coverage may be accessed at www.onsemi.com/site/pdf/Patent-Marking.pdf. ON Semiconductor reserves the right to make changes without further notice to any products herein. ON Semiconductor makes no warranty, representation or guarantee regarding the suitability of its products for any particular purpose, nor does ON Semiconductor assume any liability arising out of the application or use of any product or circuit, and specifically disclaims any and all liability, including without limitation special, consequential or incidental damages. Buyer is responsible for its products and applications using ON Semiconductor products, including compliance with all laws, regulations and safety requirements or standards, regardless of any support or applications information provided by ON Semiconductor. "Typical" parameters which may be provided in ON Semiconductor data sheets and/or specifications can and do vary in different applications and actual performance may vary over time. All operating parameters, including "Typicals" must be validated for each customer application by customer's technical experts. ON Semiconductor does not convey any license under its patent rights nor the rights of others. ON Semiconductor products are not designed, intended, or authorized for use as a critical component in life support systems or any FDA Class 3 medical devices or medical devices with a same or similar classification in a foreign jurisdiction or any devices intended for implantation in the human body. Should Buyer purchase or use ON Semiconductor products for any such unintended or unauthorized application, Buyer shall indemnify and hold ON Semiconductor and its officers, employees, subsidiaries, affiliates, and distributors harmless against all claims, costs, damages, and expenses, and reasonable attorney fees arising out of, directly or indirectly, any claim of personal injury or death associated with such unintended or unauthorized use, even if such claim alleges that ON Semiconductor was negligent regarding the design or manufacture of the part. ON Semiconductor is an Equal Opportunity/Affirmative Action Employer. This literature is subject to all applicable copyright laws and is not for resale in any manner.

PUBLICATION ORDERING INFORMATION

LITERATURE FULFILLMENT:

Literature Distribution Center for ON Semiconductor
19521 E. 32nd Pkwy, Aurora, Colorado 80011 USA
Phone: 303-675-2175 or 800-344-3860 Toll Free USA/Canada
Fax: 303-675-2176 or 800-344-3867 Toll Free USA/Canada
Email: orderlit@onsemi.com

N. American Technical Support: 800-282-9855 Toll Free
USA/Canada
Europe, Middle East and Africa Technical Support:
Phone: 421 33 790 2910

ON Semiconductor Website: www.onsemi.com

Order Literature: <http://www.onsemi.com/orderlit>

For additional information, please contact your local Sales Representative