



2SC5536A

RF Transistor 12V, 50mA, $f_T=1.7\text{GHz}$, NPN Single SSFP

ON Semiconductor®

<http://onsemi.com>

Features

- Low-noise : NF=1.8dB typ (f=150MHz)
- High gain : $|S_{21e}|^2=16\text{dB}$ typ (f=150MHz)
- Ultrasmall, slim flat-lead package (1.4mm×0.8mm×0.6mm)
- Halogen free compliance

Specifications

Absolute Maximum Ratings at $T_a=25^\circ\text{C}$

Parameter	Symbol	Conditions	Ratings	Unit
Collector-to-Base Voltage	V_{CBO}		20	V
Collector-to-Emitter Voltage	V_{CEO}		12	V
Emitter-to-Base Voltage	V_{EBO}		2	V
Collector Current	I_C		50	mA
Collector Dissipation	P_C		100	mW
Junction Temperature	T_j		150	$^\circ\text{C}$
Storage Temperature	T_{stg}		-55 to +150	$^\circ\text{C}$

Stresses exceeding Maximum Ratings may damage the device. Maximum Ratings are stress ratings only. Functional operation above the Recommended Operating Conditions is not implied. Extended exposure to stresses above the Recommended Operating Conditions may affect device reliability.

Package Dimensions

unit : mm (typ)

7029A-002

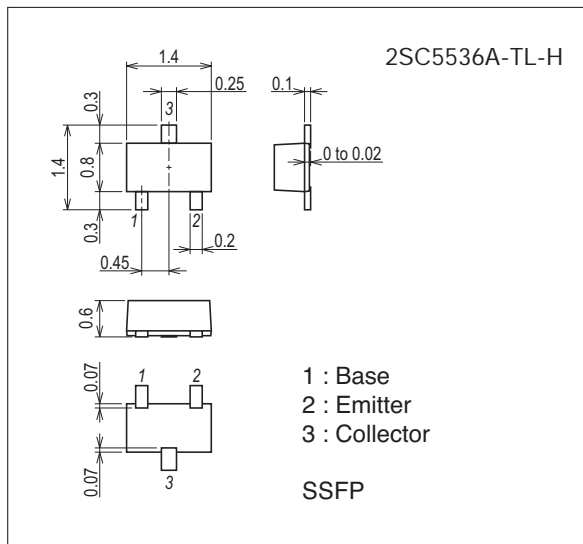

Product & Package Information

- Package : SSFP
- JEITA, JEDEC : SC-81
- Minimum Packing Quantity : 8,000 pcs./reel

Packing Type: TL

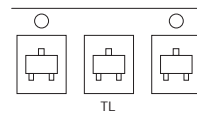

Marking

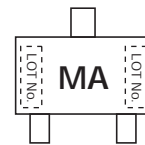

Electrical Connection

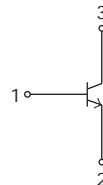

2SC5536A

Electrical Characteristics at Ta=25°C

Parameter	Symbol	Conditions	Ratings			Unit
			min	typ	max	
Collector Cutoff Current	I_{CBO}	$V_{CB}=10V, I_E=0A$			1.0	μA
Emitter Cutoff Current	I_{EBO}	$V_{EB}=1V, I_C=0A$			10	μA
DC Current Gain	h_{FE1}	$V_{CE}=2V, I_C=3mA$	80		200	
	h_{FE2}	$V_{CE}=2V, I_C=50mA$	70			
Gain-Bandwidth Product	f_T	$V_{CE}=2V, I_C=3mA$	1.0	1.7		GHz
Output Capacitance	C_{ob}	$V_{CB}=10V, f=1MHz$		1.1	1.8	pF
Reverse Transfer Capacitance	C_{re}			0.8		pF
Forward Transfer Gain	$ S_{21e} ^2$	$V_{CE}=2V, I_C=3mA, f=150MHz$	13	16		dB
Noise Figure	NF			1.8	3.0	dB

Ordering Information

Device	Package	Shipping	memo
2SC5536A-TL-H	SSFP	8,000pcs./reel	Pb Free and Halogen Free

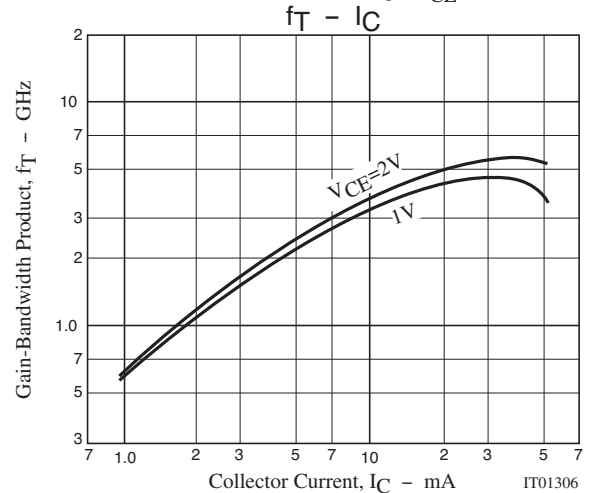
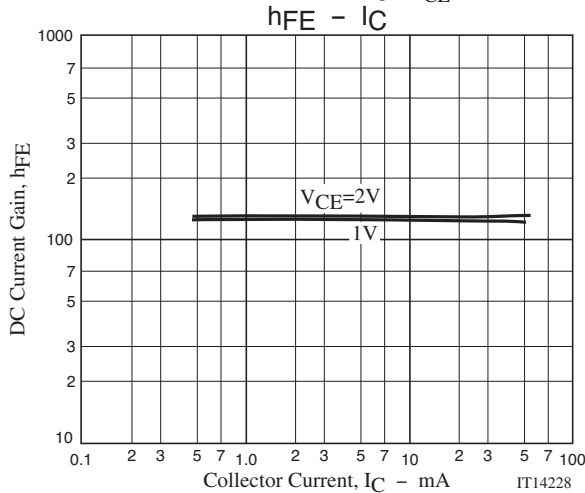
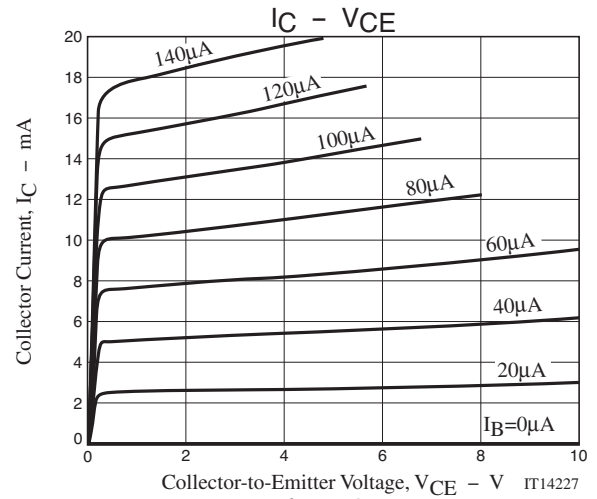
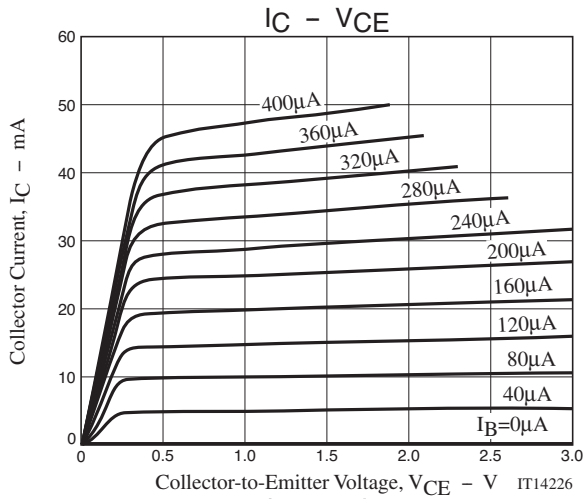

2SC5536A

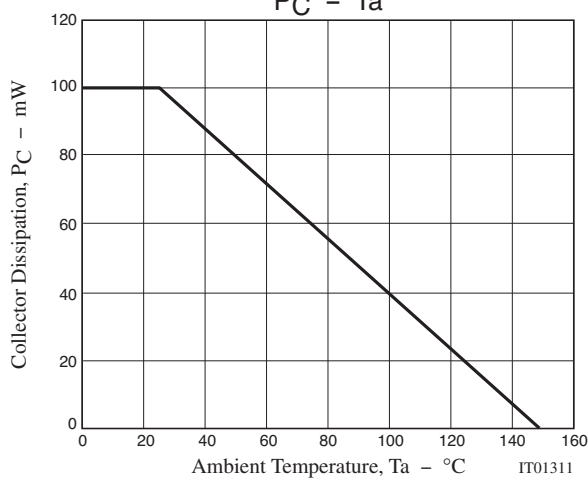
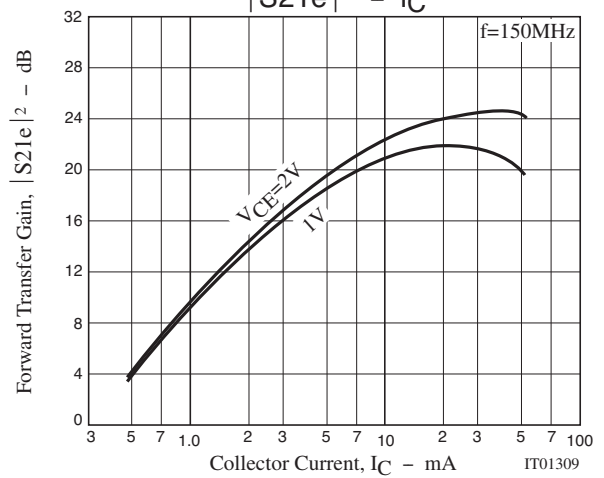
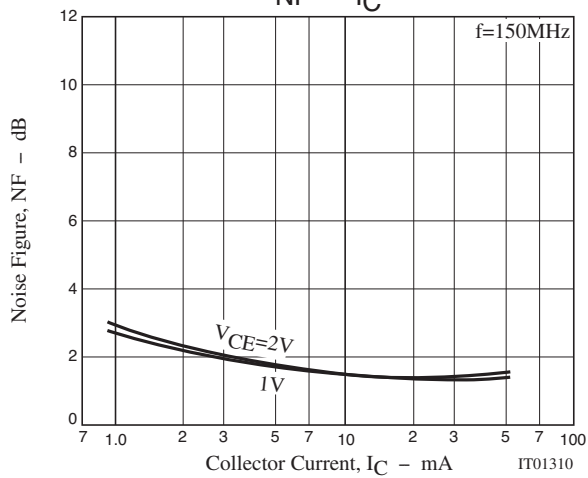
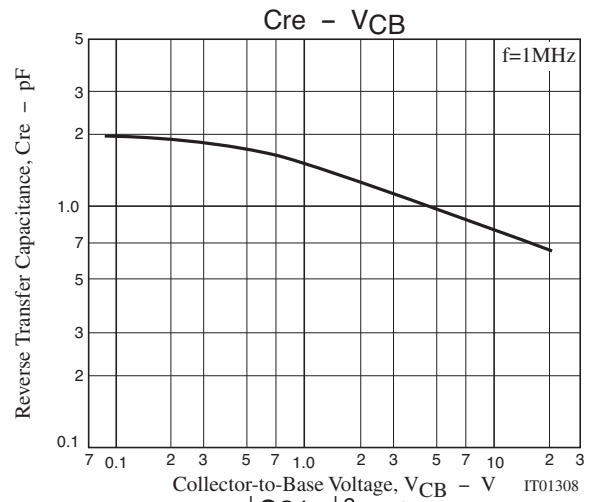
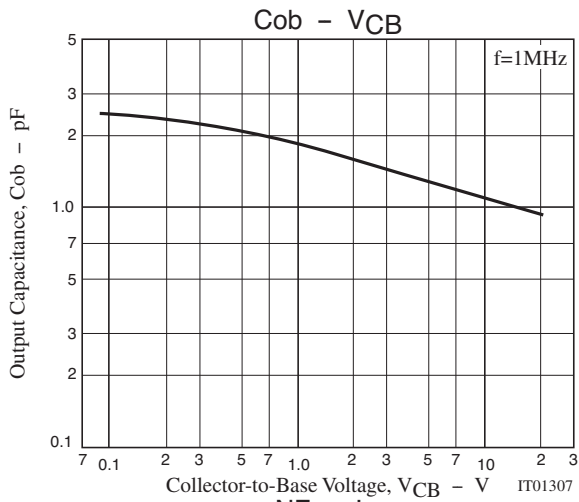

2SC5536A

S Parameters (Common emitter)

$V_{CE}=2V, I_C=1mA, Z_O=50\Omega$

Freq(MHz)	S11	$\angle S11$	S21	$\angle S21$	S12	$\angle S12$	S22	$\angle S22$
50	0.961	-26.3	3.67	162.9	0.040	74.8	0.980	-7.3
100	0.937	-52.0	2.90	148.5	0.074	61.5	0.938	-13.4
150	0.917	-72.8	2.69	135.6	0.099	50.4	0.890	-18.0
200	0.890	-89.5	2.47	125.0	0.114	41.3	0.843	-21.5
250	0.893	-100.7	2.23	116.6	0.124	33.8	0.803	-24.4
300	0.880	-111.3	1.93	108.8	0.130	28.3	0.785	-26.5
350	0.868	-122.4	1.83	102.9	0.135	23.9	0.747	-28.6
400	0.873	-127.6	1.58	96.8	0.136	19.9	0.747	-30.5
450	0.858	-135.4	1.52	92.7	0.137	16.8	0.720	-32.3
500	0.866	-138.9	1.31	87.3	0.135	14.0	0.724	-34.3

$V_{CE}=2V, I_C=3mA, Z_O=50\Omega$

Freq(MHz)	S11	$\angle S11$	S21	$\angle S21$	S12	$\angle S12$	S22	$\angle S22$
50	0.888	-37.5	9.15	157.9	0.038	69.9	0.942	-15.0
100	0.860	-68.6	8.01	140.2	0.064	54.0	0.829	-26.1
150	0.835	-91.8	6.76	127.0	0.080	43.3	0.723	-32.9
200	0.810	-108.7	5.56	117.8	0.088	35.6	0.636	-36.7
250	0.800	-121.4	4.93	110.1	0.095	30.8	0.581	-39.1
300	0.792	-130.6	4.17	104.6	0.098	27.4	0.533	-40.9
350	0.791	-137.9	3.73	98.9	0.098	24.8	0.510	-42.2
400	0.787	-143.8	3.28	95.2	0.100	23.0	0.482	-43.3
450	0.785	-148.4	2.99	91.0	0.098	22.2	0.472	-44.6
500	0.783	-152.5	2.69	88.1	0.100	21.3	0.457	-45.7

$V_{CE}=2V, I_C=10mA, Z_O=50\Omega$

Freq(MHz)	S11	$\angle S11$	S21	$\angle S21$	S12	$\angle S12$	S22	$\angle S22$
50	0.733	-64.8	22.70	145.6	0.031	60.7	0.825	-33.9
100	0.722	-105.2	16.71	125.0	0.046	44.9	0.605	-53.9
150	0.719	-126.7	12.55	113.3	0.052	38.2	0.462	-64.8
200	0.713	-139.6	9.94	106.2	0.055	36.3	0.371	-71.4
250	0.716	-147.8	8.10	101.0	0.059	35.6	0.314	-76.1
300	0.716	-153.8	6.88	96.9	0.060	36.2	0.276	-79.7
350	0.716	-158.8	5.96	93.4	0.062	37.4	0.248	-82.6
400	0.717	-162.1	5.25	90.7	0.065	38.6	0.228	-85.1
450	0.715	-165.3	4.70	88.2	0.067	40.6	0.215	-86.7
500	0.716	-167.6	4.24	85.9	0.069	42.1	0.204	-88.6

$V_{CE}=2V, I_C=30mA, Z_O=50\Omega$

Freq(MHz)	S11	$\angle S11$	S21	$\angle S21$	S12	$\angle S12$	S22	$\angle S22$
50	0.605	-104.0	36.87	131.9	0.022	54.3	0.672	-59.9
100	0.660	-137.6	23.04	112.9	0.030	44.3	0.450	-89.4
150	0.677	-151.7	16.23	104.1	0.034	45.3	0.352	-106.7
200	0.681	-159.5	12.43	99.4	0.038	47.4	0.302	-118.6
250	0.686	-164.5	10.04	95.6	0.042	50.8	0.276	-127.0
300	0.687	-168.1	8.44	92.8	0.045	53.9	0.260	-133.7
350	0.689	-170.8	7.27	90.2	0.050	56.5	0.251	-138.8
400	0.691	-173.0	6.38	88.3	0.055	58.3	0.244	-142.9
450	0.691	-174.8	5.70	86.4	0.059	60.5	0.239	-145.6
500	0.691	-176.5	5.14	84.7	0.064	61.5	0.237	-148.2

Embossed Taping Specification

2SC5536A-TL-H

1. Packing Format

Package Name	Carrier Tape Type	Maximum Number of devices contained (pcs)			Packing format	
		Reel	Inner box	Outer box	Inner BOX (C-1)	Outer BOX (A-7)
SSFP	SSFP	8,000	40,000	240,000	5 reels contained Dimensions:mm (external) 183×72×185	6 inner boxes contained Dimensions:mm (external) 440×195×210

Packing method

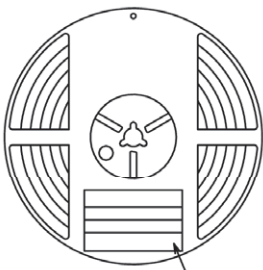

Reel label

Reel label, Inner box label
(unit:mm)

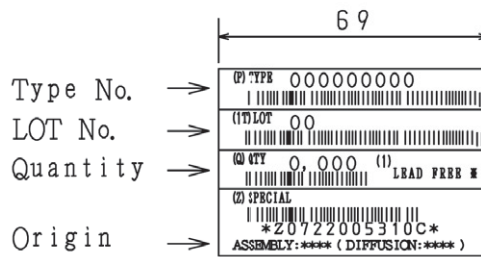

Outer box label
It is a label at the time of factory shipments. The form of a label may change in physical distribution process.

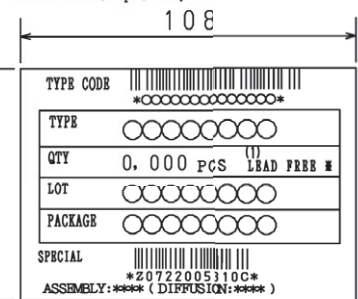

NOTE (1)

The LEAD FREE * description shows that the surface treatment of the terminal is lead free.

Label	JEITA Phase
LEAD FREE 3	JEITA Phase 3A
LEAD FREE 4	JEITA Phase 3

2. Taping configuration

2-1. Carrier tape size (unit:mm)

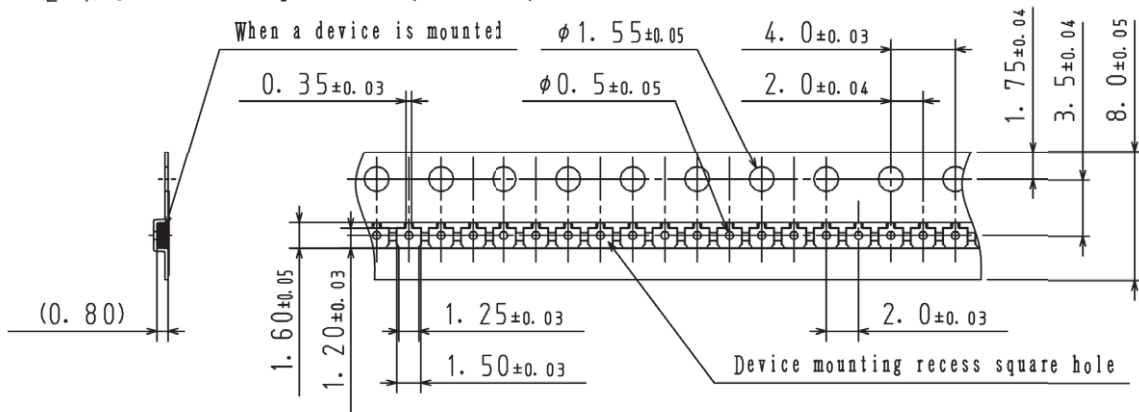

2-2. Device placement direction

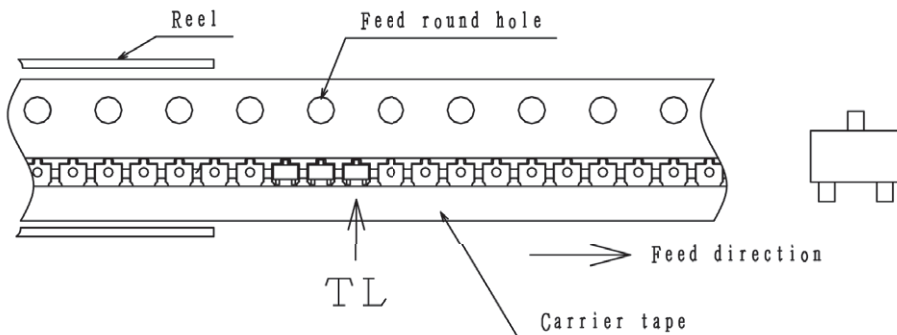

Those with pin 1 index on the feed hole side.....TL

2SC5536A

Outline Drawing

2SC5536A-TL-H

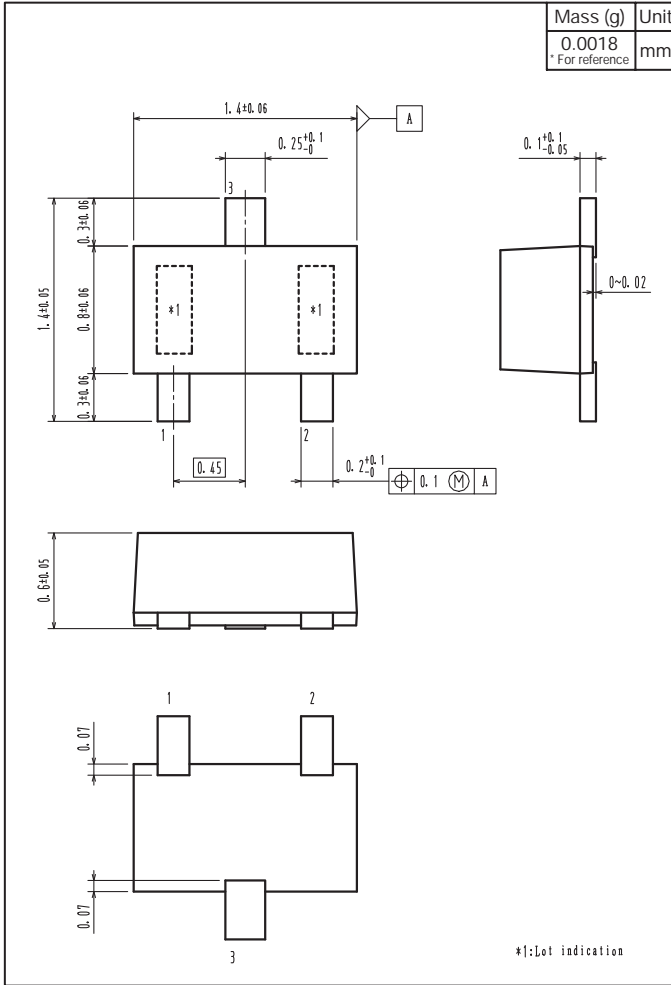

Land Pattern Example

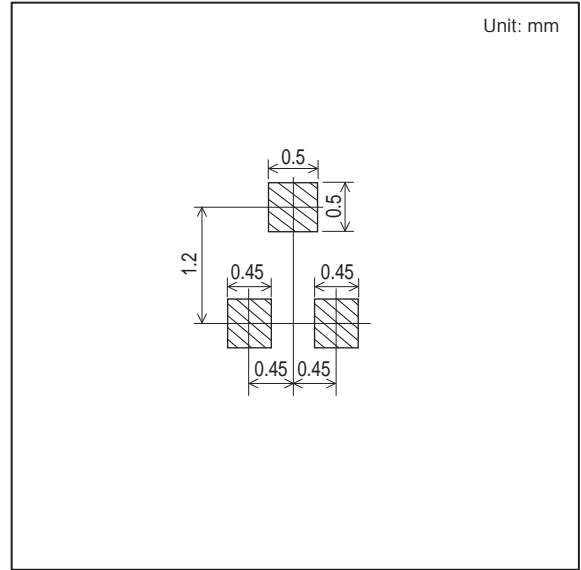

ON Semiconductor and the ON logo are registered trademarks of Semiconductor Components Industries, LLC (SCILLC). SCILLC owns the rights to a number of patents, trademarks, copyrights, trade secrets, and other intellectual property. A listing of SCILLC's product/patent coverage may be accessed at www.onsemi.com/site/pdf/Patent-Marking.pdf. SCILLC reserves the right to make changes without further notice to any products herein. SCILLC makes no warranty, representation or guarantee regarding the suitability of its products for any particular purpose, nor does SCILLC assume any liability arising out of the application or use of any product or circuit, and specifically disclaims any and all liability, including without limitation special, consequential or incidental damages. "Typical" parameters which may be provided in SCILLC data sheets and/or specifications can and do vary in different applications and actual performance may vary over time. All operating parameters, including "Typicals" must be validated for each customer application by customer's technical experts. SCILLC does not convey any license under its patent rights nor the rights of others. SCILLC products are not designed, intended, or authorized for use as components in systems intended for surgical implant into the body, or other applications intended to support or sustain life, or for any other application in which the failure of the SCILLC product could create a situation where personal injury or death may occur. Should Buyer purchase or use SCILLC products for any such unintended or unauthorized application, Buyer shall indemnify and hold SCILLC and its officers, employees, subsidiaries, affiliates, and distributors harmless against all claims, costs, damages, and expenses, and reasonable attorney fees arising out of, directly or indirectly, any claim of personal injury or death associated with such unintended or unauthorized use, even if such claim alleges that SCILLC was negligent regarding the design or manufacture of the part. SCILLC is an Equal Opportunity/Affirmative Action Employer. This literature is subject to all applicable copyright laws and is not for resale in any manner.