

Features

- High junction temperature capability
- Avalanche capability specified
- Low forward voltage drop current
- High frequency operation
- Insulated package
 - TO-220FPAB
 - Insulating voltage = 1500 V rms
 - Typical package capacitance 12 pF

Description

Dual center tap Schottky rectifier suited for high frequency switch mode power supplies.

Packaged in TO-220AB and TO-220FPAB, this device provides the adaptor designers with an optimized price-performance ratio.

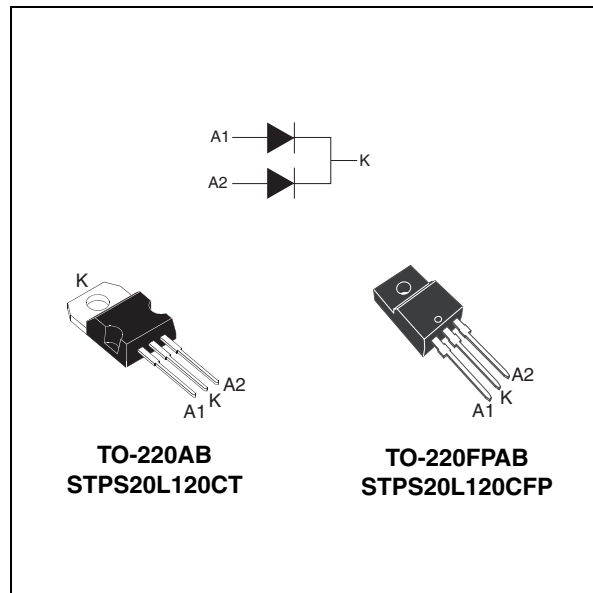

Table 1. Device summary

$I_{F(AV)}$	2 x 10 A
V_{RRM}	120 V
$T_{j(max)}$	150 °C
$V_{F(typ)}$	0.55 V

1 Characteristics

Table 2. Absolute ratings (limiting values, per diode)

Symbol	Parameter		Value	Unit
V_{RRM}	Repetitive peak reverse voltage		120	V
$I_{F(RMS)}$	Forward rms current		20	A
$I_{F(AV)}$	Average forward current, $\delta = 0.5$	Total package	20	A
I_{FSM}	Surge non repetitive forward current	$t_p = 10 \text{ ms}$ Sinusoidal	200	A
P_{ARM}	Repetitive peak avalanche power	$t_p = 1 \mu\text{s}$ $T_j = 25 \text{ }^\circ\text{C}$	8000	W
T_{stg}	Storage temperature range		-65 to + 175	$^\circ\text{C}$
T_j	Maximum operating junction temperature ⁽¹⁾		150	$^\circ\text{C}$

1. $\frac{dP_{Tot}}{dT_j} < \frac{1}{R_{th(j-a)}}$ condition to avoid thermal runaway for a diode on its own heatsink

Table 3. Thermal parameters

Symbol	Parameter		Value	Unit	
$R_{th(j-c)}$	Junction to case	TO-220AB	Per diode Total	2 1.1	$^\circ\text{C/W}$
		TO-220FPAB	Per diode Total	4.9 4.1	
		TO-220AB	Total	0.2	
				3.2	
$R_{th(c)}$	Coupling	TO-220AB	Total	0.2	
		TO-220FPAB		3.2	

When the diodes 1 and 2 are used simultaneously :

$$T_j(\text{diode 1}) = P(\text{diode 1}) \times R_{th(j-c)}(\text{per diode}) + P(\text{diode 2}) \times R_{th(c)}$$

Table 4. Static electrical characteristics (per diode)

Symbol	Test conditions		Min.	Typ.	Max.	Unit
$I_R^{(1)}$	Reverse leakage current	$T_j = 25 \text{ }^\circ\text{C}$	-	-	120	μA
		$T_j = 125 \text{ }^\circ\text{C}$	-	8	25	mA
$V_F^{(2)}$	Forward voltage drop	$T_j = 25 \text{ }^\circ\text{C}$	-	-	0.74	V
		$T_j = 125 \text{ }^\circ\text{C}$			-	
		$T_j = 25 \text{ }^\circ\text{C}$	-	-	0.86	
		$T_j = 125 \text{ }^\circ\text{C}$			-	
		$T_j = 25 \text{ }^\circ\text{C}$	-	-	1	
		$T_j = 125 \text{ }^\circ\text{C}$			-	

1. Pulse test : $t_p = 5 \text{ ms}$, $\delta < 2\%$

2. Pulse test : $t_p = 380 \mu\text{s}$, $\delta < 2\%$

To evaluate the maximum conduction losses use the following equation :

$$P = 0.595 \times I_{F(AV)} + 0.0095 I_{F(RMS)}^2$$

Figure 1. Average forward power dissipation vs. average forward current (per diode)

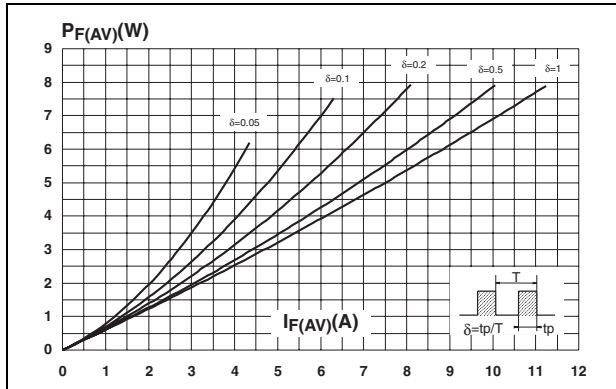

Figure 2. Average forward current vs. ambient temperature ($\delta = 0.5$, per diode)

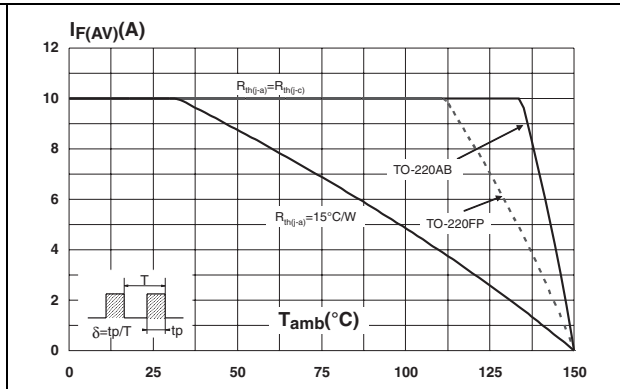

Figure 3. Normalized avalanche power derating vs. pulse duration

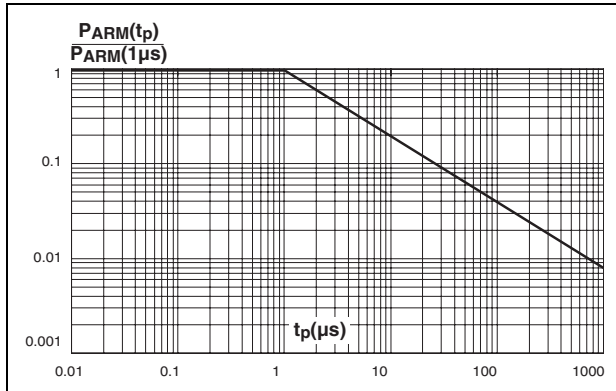

Figure 4. Normalized avalanche power derating vs. junction temperature

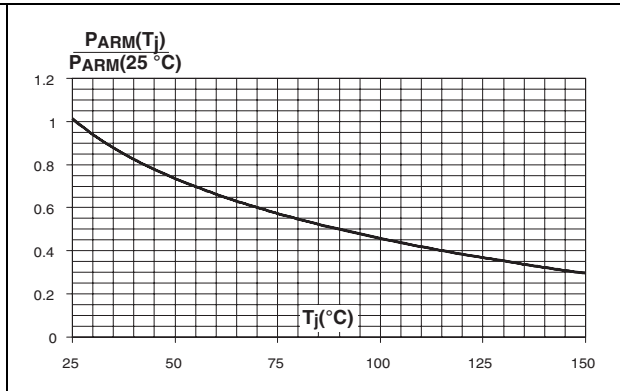

Figure 5. Non repetitive surge peak forward current vs. overload duration (max. values, per diode) (TO-220AB)

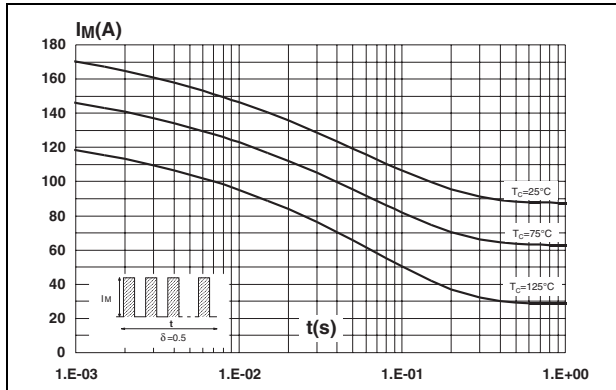

Figure 6. Non repetitive surge peak forward current vs. overload duration (max. values, per diode) (TO-220FPAB)

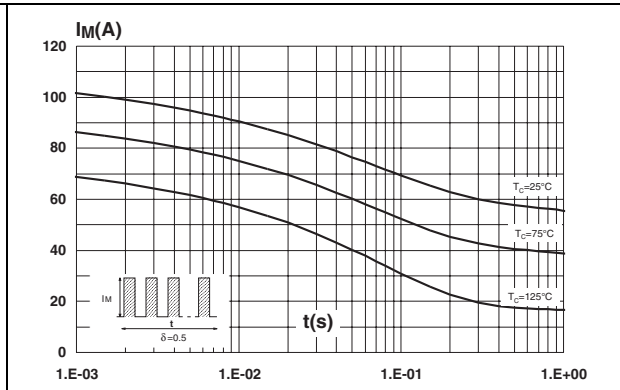

Figure 7. Relative variation of thermal impedance junction to case vs. pulse duration (TO-220AB)

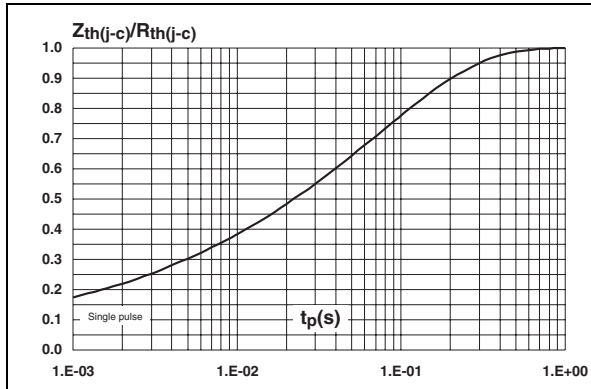

Figure 8. Relative variation of thermal impedance junction to case vs. pulse duration (TO-220FPAB)

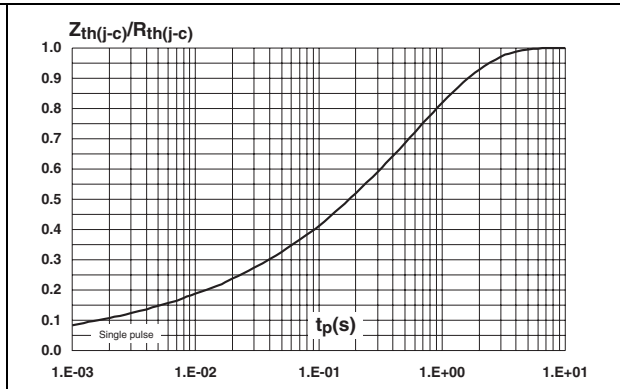

Figure 9. Reverse leakage current vs. reverse voltage applied (typical values, per diode)

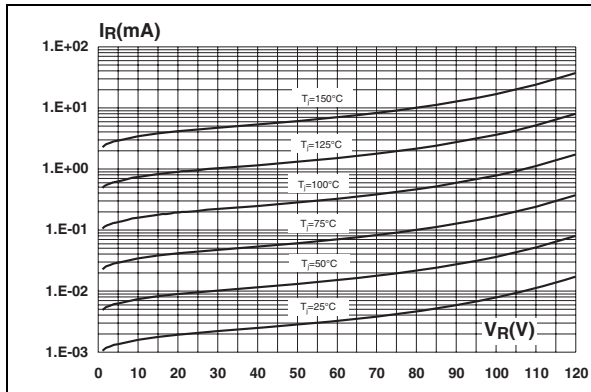

Figure 10. Junction capacitance vs. reverse voltage applied (typical values, per diode)

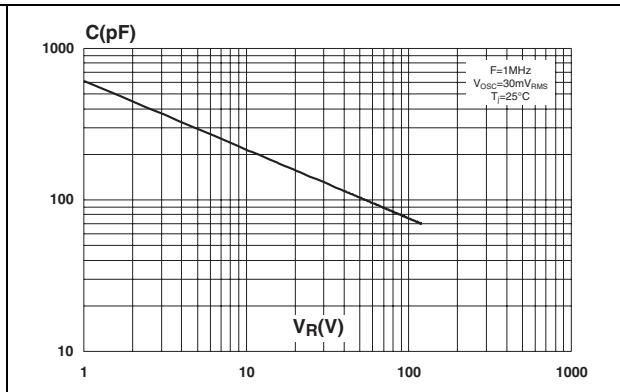
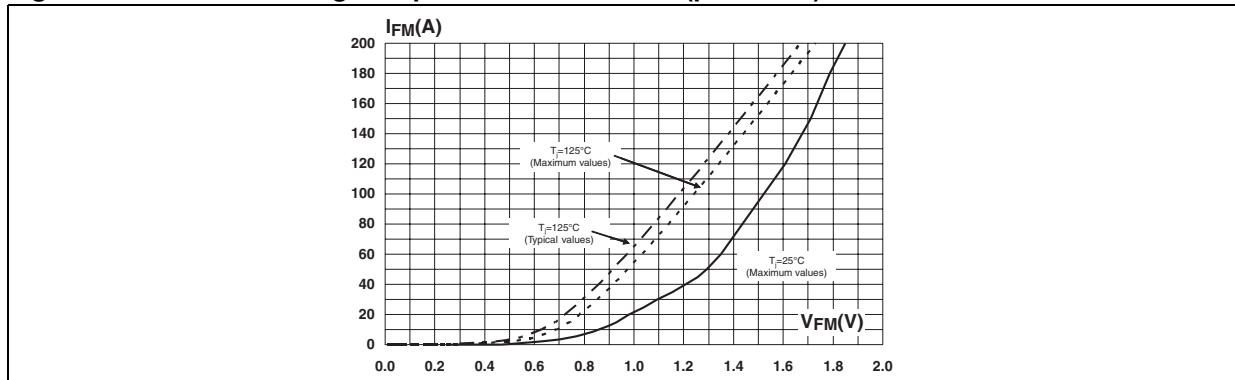

Figure 11. Forward voltage drop vs. forward current (per diode)



2 Package information

- Epoxy meets UL94, V0
- Cooling method: by conduction (C)
- Recommended torque value: 0.4 to 0.6 N·m

In order to meet environmental requirements, ST offers these devices in different grades of ECOPACK® packages, depending on their level of environmental compliance. ECOPACK® specifications, grade definitions and product status are available at: www.st.com. ECOPACK® is an ST trademark.

Table 5. TO-220AB dimensions

Ref.	Dimensions			
	Millimeters		Inches	
	Min.	Max.	Min.	Max.
A	4.40	4.60	0.173	0.181
C	1.23	1.32	0.048	0.051
D	2.40	2.72	0.094	0.107
E	0.49	0.70	0.019	0.027
F	0.61	0.88	0.024	0.034
F1	1.14	1.70	0.044	0.066
F2	1.14	1.70	0.044	0.066
G	4.95	5.15	0.194	0.202
G1	2.40	2.70	0.094	0.106
H2	10	10.40	0.393	0.409
L2	16.4 typ.		0.645 typ.	
L4	13	14	0.511	0.551
L5	2.65	2.95	0.104	0.116
L6	15.25	15.75	0.600	0.620
L7	6.20	6.60	0.244	0.259
L9	3.50	3.93	0.137	0.154
M	2.6 typ.		0.102 typ.	
Diam.	3.75	3.85	0.147	0.151

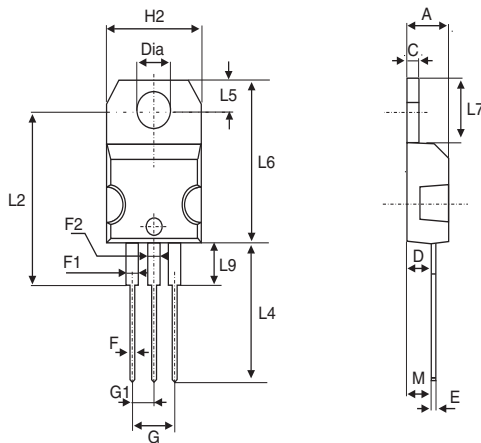
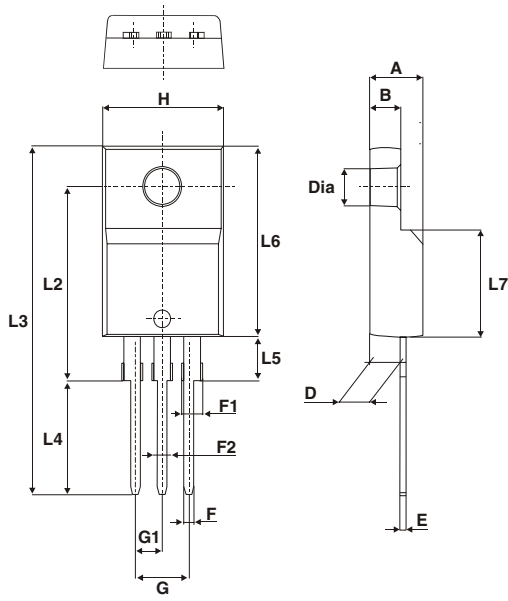

Table 6. TO-220FPAB dimensions

Ref.	Dimensions			
	Millimeters		Inches	
	Min.	Max.	Min.	Max.
A	4.4	4.6	0.173	0.181
B	2.5	2.7	0.098	0.106
D	2.5	2.75	0.098	0.108
E	0.45	0.70	0.018	0.027
F	0.75	1	0.030	0.039
F1	1.15	1.50	0.045	0.059
F2	1.15	1.50	0.045	0.059
G	4.95	5.20	0.195	0.205
G1	2.4	2.7	0.094	0.106
H	10	10.4	0.393	0.409
L2	16 Typ.		0.63 Typ.	
L3	28.6	30.6	1.126	1.205
L4	9.8	10.6	0.386	0.417
L5	2.9	3.6	0.114	0.142
L6	15.9	16.4	0.626	0.646
L7	9.00	9.30	0.354	0.366
Dia.	3.00	3.20	0.118	0.126



3 Ordering information

Table 7. Ordering information

Order code	Marking	Package	Weight	Base qty	Delivery mode
STPS20L120CT	STPS20L120CT	TO-220AB	2.2 g	50	Tube
STPS20L120CFP	STPS20L120CFP	TO-220FPAB	2.0 g	50	Tube

4 Revision history

Table 8. Document revision history

Date	Revision	Changes
20-May-2009	1	First issue

Please Read Carefully:

Information in this document is provided solely in connection with ST products. STMicroelectronics NV and its subsidiaries ("ST") reserve the right to make changes, corrections, modifications or improvements, to this document, and the products and services described herein at any time, without notice.

All ST products are sold pursuant to ST's terms and conditions of sale.

Purchasers are solely responsible for the choice, selection and use of the ST products and services described herein, and ST assumes no liability whatsoever relating to the choice, selection or use of the ST products and services described herein.

No license, express or implied, by estoppel or otherwise, to any intellectual property rights is granted under this document. If any part of this document refers to any third party products or services it shall not be deemed a license grant by ST for the use of such third party products or services, or any intellectual property contained therein or considered as a warranty covering the use in any manner whatsoever of such third party products or services or any intellectual property contained therein.

UNLESS OTHERWISE SET FORTH IN ST'S TERMS AND CONDITIONS OF SALE ST DISCLAIMS ANY EXPRESS OR IMPLIED WARRANTY WITH RESPECT TO THE USE AND/OR SALE OF ST PRODUCTS INCLUDING WITHOUT LIMITATION IMPLIED WARRANTIES OF MERCHANTABILITY, FITNESS FOR A PARTICULAR PURPOSE (AND THEIR EQUIVALENTS UNDER THE LAWS OF ANY JURISDICTION), OR INFRINGEMENT OF ANY PATENT, COPYRIGHT OR OTHER INTELLECTUAL PROPERTY RIGHT.

UNLESS EXPRESSLY APPROVED IN WRITING BY AN AUTHORIZED ST REPRESENTATIVE, ST PRODUCTS ARE NOT RECOMMENDED, AUTHORIZED OR WARRANTED FOR USE IN MILITARY, AIR CRAFT, SPACE, LIFE SAVING, OR LIFE SUSTAINING APPLICATIONS, NOR IN PRODUCTS OR SYSTEMS WHERE FAILURE OR MALFUNCTION MAY RESULT IN PERSONAL INJURY, DEATH, OR SEVERE PROPERTY OR ENVIRONMENTAL DAMAGE. ST PRODUCTS WHICH ARE NOT SPECIFIED AS "AUTOMOTIVE GRADE" MAY ONLY BE USED IN AUTOMOTIVE APPLICATIONS AT USER'S OWN RISK.

Resale of ST products with provisions different from the statements and/or technical features set forth in this document shall immediately void any warranty granted by ST for the ST product or service described herein and shall not create or extend in any manner whatsoever, any liability of ST.

ST and the ST logo are trademarks or registered trademarks of ST in various countries.

Information in this document supersedes and replaces all information previously supplied.

The ST logo is a registered trademark of STMicroelectronics. All other names are the property of their respective owners.

© 2009 STMicroelectronics - All rights reserved

STMicroelectronics group of companies

Australia - Belgium - Brazil - Canada - China - Czech Republic - Finland - France - Germany - Hong Kong - India - Israel - Italy - Japan - Malaysia - Malta - Morocco - Philippines - Singapore - Spain - Sweden - Switzerland - United Kingdom - United States of America

www.st.com