



STPS2030CT/CG/CR

LOW DROP POWER SCHOTTKY RECTIFIER

MAJOR PRODUCTS CHARACTERISTICS

| | |
|-------------------|----------|
| $I_{F(AV)}$ | 2 x 10 A |
| V_{RRM} | 30 V |
| $T_j(\text{max})$ | 150°C |
| $V_F(\text{max})$ | 0.40 V |

FEATURES AND BENEFITS

- VERY SMALL CONDUCTION LOSSES
- NEGLIGIBLE SWITCHING LOSSES
- EXTREMELY FAST SWITCHING
- LOW FORWARD VOLTAGE DROP FOR HIGHER EFFICIENCY
- LOW THERMAL RESISTANCE
- AVALANCHE CAPABILITY SPECIFIED

DESCRIPTION

Dual Schottky rectifier suited for switch Mode Power Supply and high frequency DC to DC converters.

Packaged in TO-220AB, D²PAK and I²PAK, this device is intended for use in low voltage high frequency inverters, free wheeling and polarity protection applications.

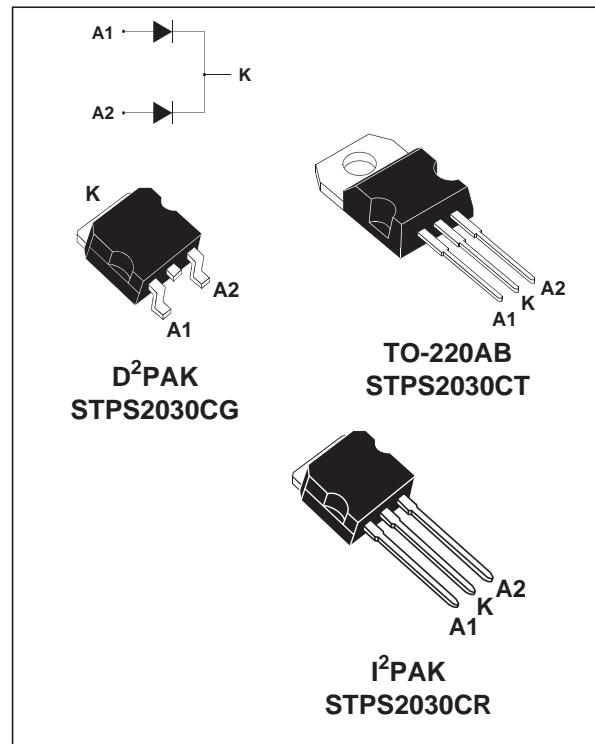

ABSOLUTE RATINGS (limiting values, per diode)

| Symbol | Parameter | | Value | Unit |
|--------------|--|--|-------------------------------|------------------|
| V_{RRM} | Repetitive peak reverse voltage | | 30 | V |
| $I_{F(RMS)}$ | RMS forward current | | 30 | A |
| $I_{F(AV)}$ | Average forward current | $T_c = 140^\circ\text{C}$ $\delta = 0.5$ | Per diode 20 Per device | A |
| I_{FSM} | Surge non repetitive forward current | $t_p = 10 \text{ ms}$ Sinusoidal | 180 | A |
| I_{RRM} | Peak repetitive reverse current | $t_p = 2 \mu\text{s}$ square $F = 1\text{kHz}$ | 1 | A |
| I_{RSM} | Non repetitive peak reverse current | $t_p = 100 \mu\text{s}$ square | 2 | A |
| P_{ARM} | Repetitive peak avalanche power | $t_p = 1 \mu\text{s}$ $T_j = 25^\circ\text{C}$ | 3000 | W |
| T_{stg} | Storage temperature range | | - 65 to + 150 | °C |
| T_j | Maximum operating junction temperature * | | 150 | °C |
| dV/dt | Critical rate of rise of reverse voltage (rated V_R , $T_j = 25^\circ\text{C}$) | | 10000 | V/ μs |

* : $\frac{dP_{tot}}{dT_j} < \frac{1}{R_{th(j-a)}}$ thermal runaway condition for a diode on its own heatsink

STPS2030CT/CG/CR

THERMAL RESISTANCES

| Symbol | Parameter | Value | Unit |
|---------------|---|-----------|------|
| $R_{th(j-c)}$ | Junction to case TO-220AB - D ² PAK - I ² PAK | Per diode | 2.2 |
| | | Total | 1.3 |
| $R_{th(c)}$ | Coupling | 0.3 | °C/W |

STATIC ELECTRICAL CHARACTERISTICS (per diode)

| Symbol | Parameter | Tests Conditions | Min. | Typ. | Max. | Unit | |
|---------|-------------------------|---------------------------|---------------------|---------------------|------|------|------|
| I_R^* | Reverse leakage current | $T_j = 25^\circ\text{C}$ | $V_R = V_{RRM}$ | 0.15 | 1.0 | mA | |
| | | $T_j = 125^\circ\text{C}$ | | 80 | 160 | | |
| V_F^* | Forward voltage drop | $T_j = 25^\circ\text{C}$ | $I_F = 10\text{ A}$ | 0.44 | 0.50 | V | |
| | | $T_j = 125^\circ\text{C}$ | | 0.34 | 0.40 | | |
| | | $T_j = 25^\circ\text{C}$ | | $I_F = 20\text{ A}$ | 0.50 | | 0.58 |
| | | $T_j = 125^\circ\text{C}$ | | | 0.44 | | 0.52 |

Pulse test : * $t_p = 380\ \mu\text{s}$, $\delta < 2\%$

To evaluate the conduction losses use the following equation :

$$P = 0.28 \times I_{F(AV)} + 0.012 I_{F(RMS)}^2$$

Fig. 1: Conduction losses versus average current.

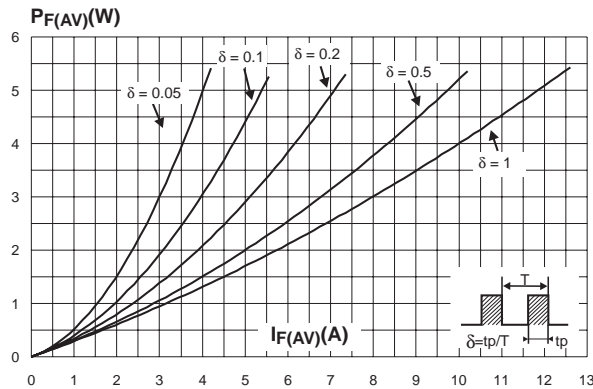

Fig. 3: Normalized avalanche power derating versus pulse duration.

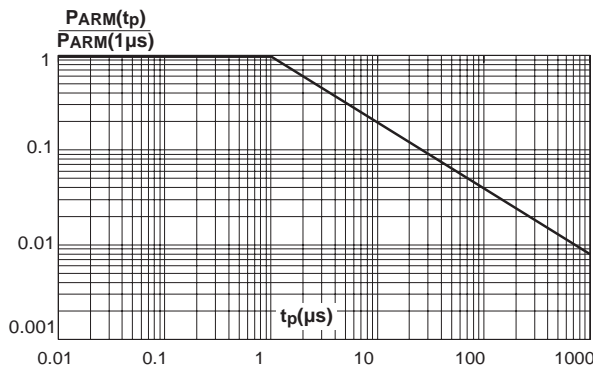

Fig. 2: Average forward current versus ambient temperature ($\delta = 0.5$).

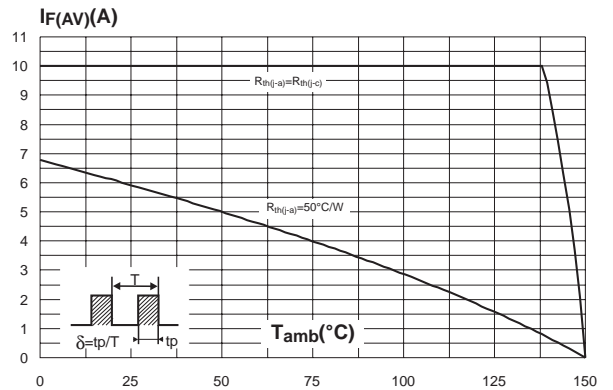

Fig. 4: Normalized avalanche power derating versus junction temperature.

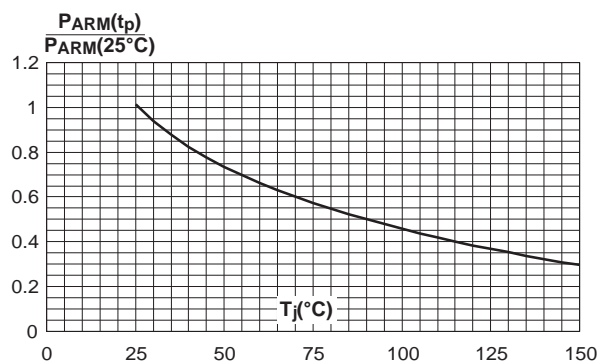

Fig. 5: Non repetitive surge peak forward current versus overload duration (maximum values).

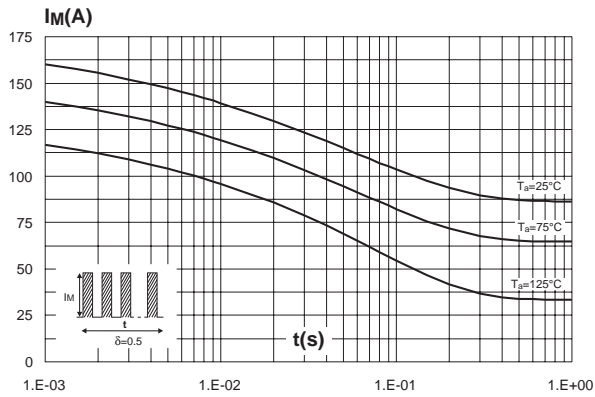

Fig. 6: Relative variation of thermal impedance junction to case versus pulse duration.

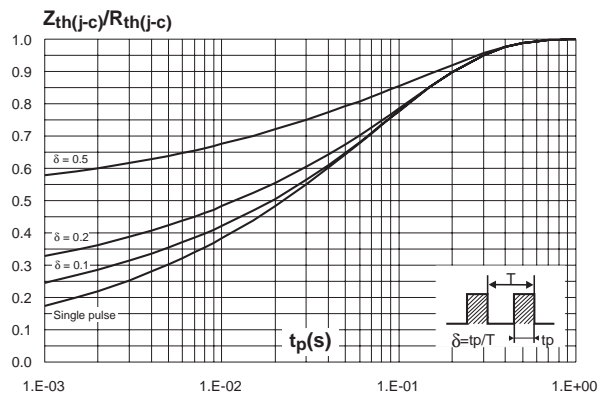

Fig. 7: Reverse leakage current versus reverse voltage applied (typical values).

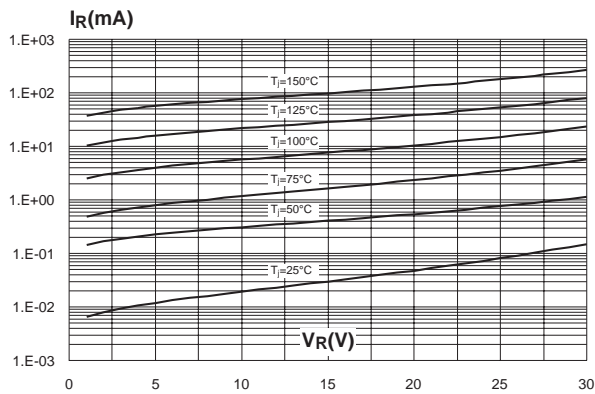

Fig. 8: Junction capacitance versus reverse voltage applied (typical values).

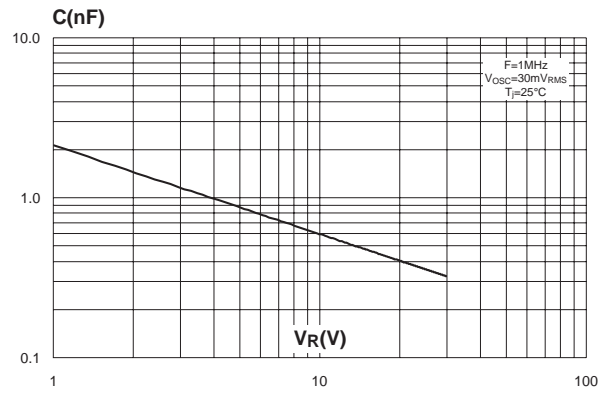

Fig. 9: Forward voltage drop versus forward current.

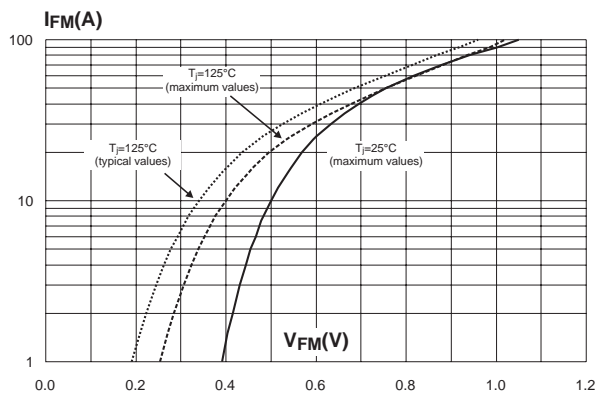
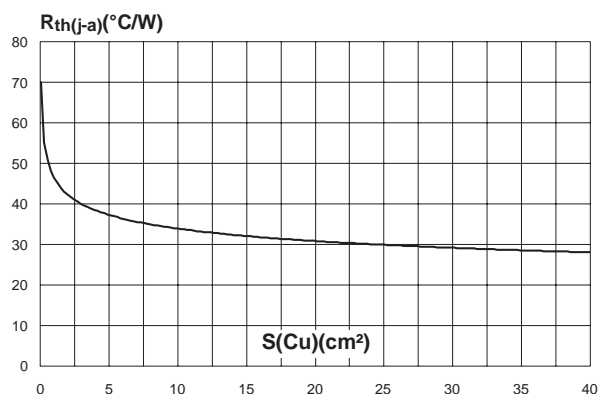
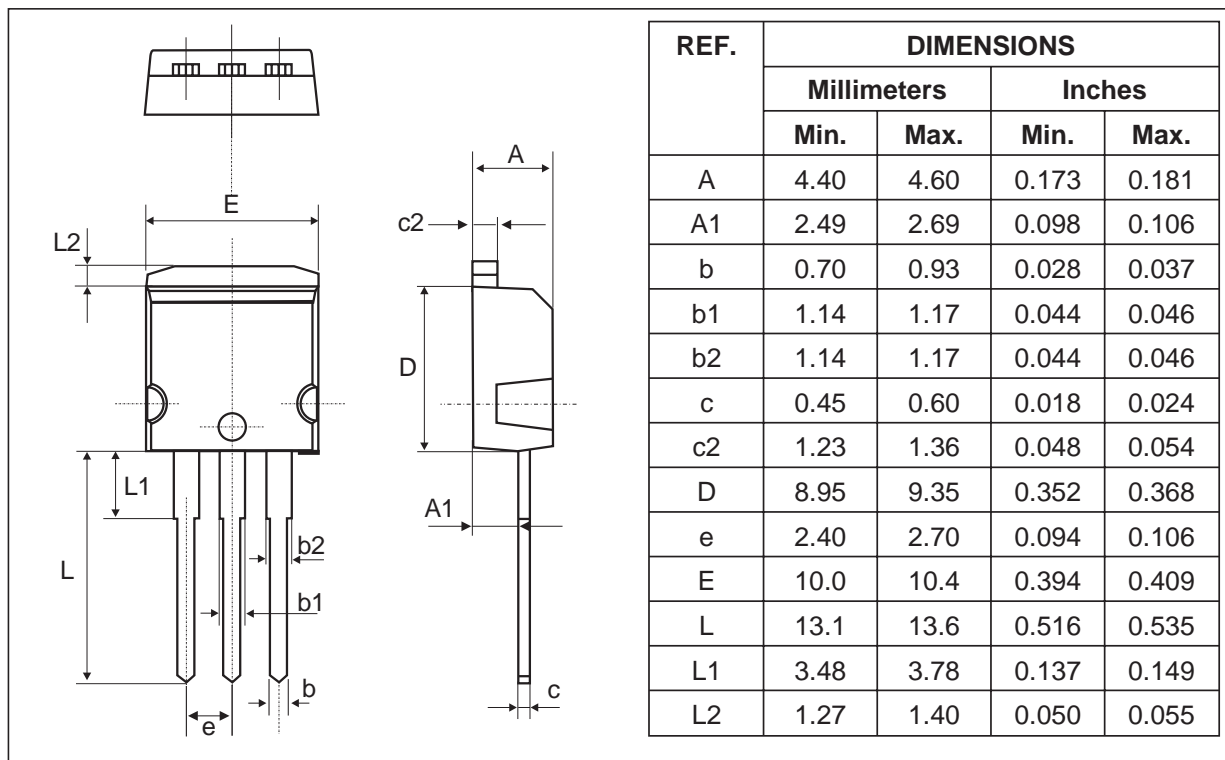

Fig. 10: Thermal resistance junction to ambient versus copper surface under tab (epoxy printed board FR4, Cu = 35µm).



PACKAGE MECHANICAL DATA
I²PAK



PACKAGE MECHANICAL DATA
D²PAK

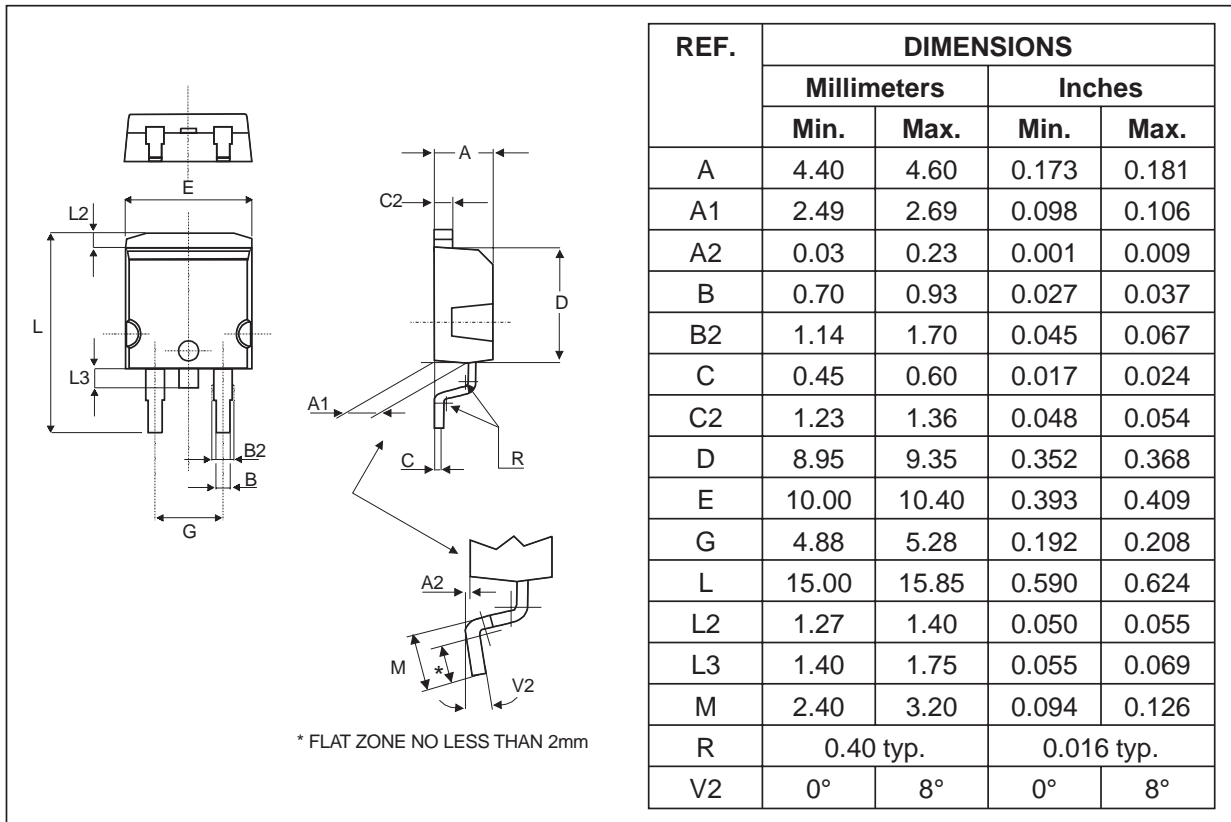

FOOTPRINT

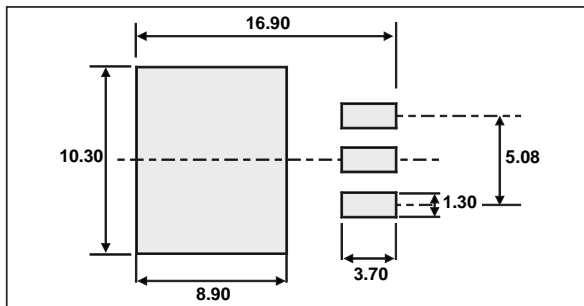

STPS2030CT/CG/CR

PACKAGE MECHANICAL DATA TO-220AB

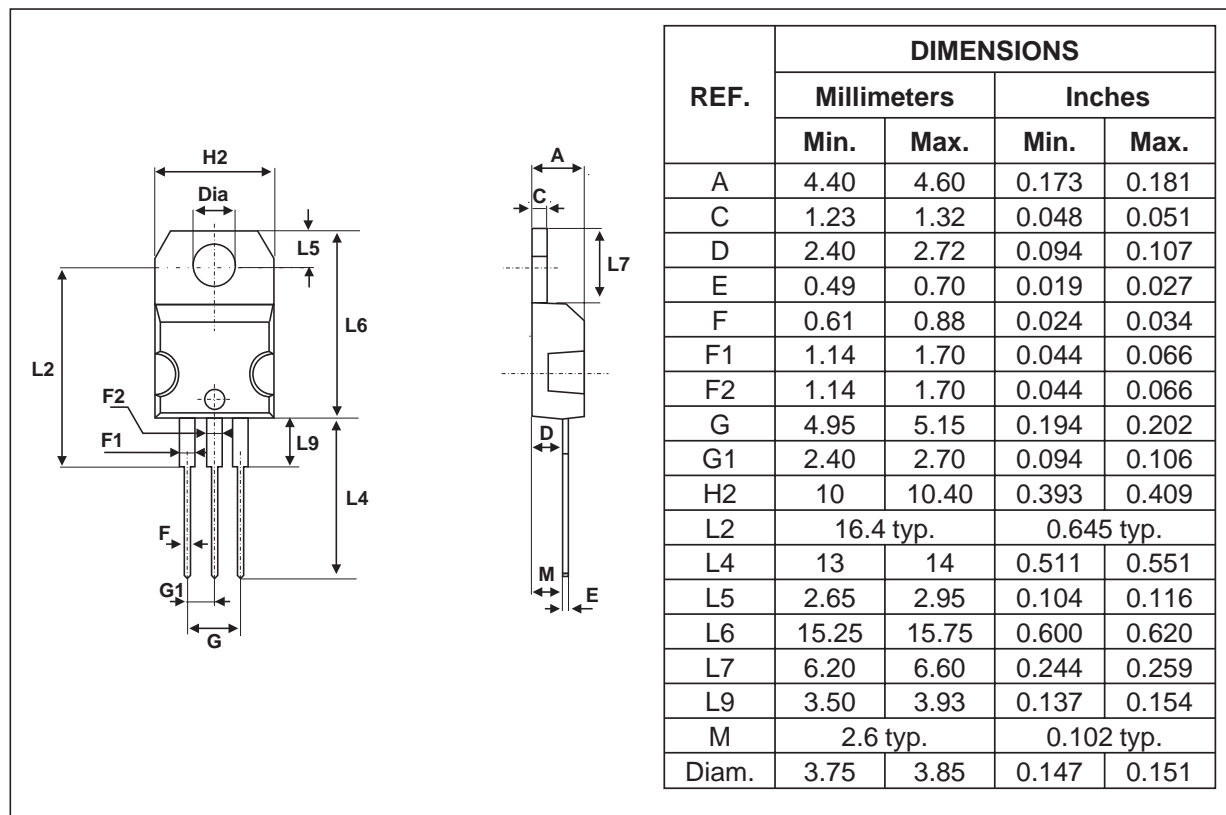

- COOLING METHOD : C
- RECOMMENDED TORQUE VALUE : 0.55 M.N
- MAXIMUM TORQUE VALUE : 0.70 M.N

| Ordering type | Marking | Package | Weight | Base qty | Delivery mode |
|---------------|------------|--------------------|--------|----------|---------------|
| STPS2030CT | STPS2030CT | TO-220AB | 2.2 g | 50 | Tube |
| STPS2030CG | STPS2030CG | D ² PAK | 1.48 g | 50 | Tube |
| STPS2030CG-TR | STPS2030CG | D ² PAK | 1.48 g | 1000 | Tape & reel |
| STPS2030CR | STPS2030CR | I ² PAK | 1.49 g | 50 | Tube |

- EPOXY MEETS UL94,V0

Information furnished is believed to be accurate and reliable. However, STMicroelectronics assumes no responsibility for the consequences of use of such information nor for any infringement of patents or other rights of third parties which may result from its use. No license is granted by implication or otherwise under any patent or patent rights of STMicroelectronics. Specifications mentioned in this publication are subject to change without notice. This publication supersedes and replaces all information previously supplied. STMicroelectronics products are not authorized for use as critical components in life support devices or systems without express written approval of STMicroelectronics.

The ST logo is a registered trademark of STMicroelectronics
 © 2003 STMicroelectronics - Printed in Italy - All rights reserved.
 STMicroelectronics GROUP OF COMPANIES
 Australia - Brazil - Canada - China - Finland - France - Germany
 Hong Kong - India - Israel - Italy - Japan - Malaysia - Malta - Morocco - Singapore
 Spain - Sweden - Switzerland - United Kingdom - United States.

<http://www.st.com>

