



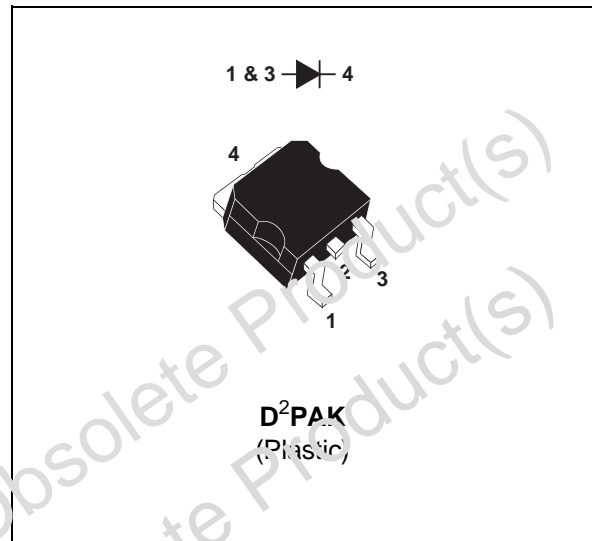
## HIGH EFFICIENCY FAST RECOVERY DIODES

### MAIN PRODUCT CHARACTERISTICS

$I_{F(AV)}$	25 A
$V_{RRM}$	200 V
$t_{rr}$	50 ns
$V_F$	0.85 V

### FEATURES AND BENEFITS

- VERY SMALL CONDUCTION LOSSES
- NEGLIGIBLE SWITCHING LOSSES
- LOW FORWARD AND REVERSE RECOVERY TIME
- HIGH SURGE CURRENT CAPABILITY
- SMD PACKAGE



### DESCRIPTION

Single rectifier suited for switchmode power supply and high frequency DC to DC converters. Packaged in D<sup>2</sup>PAK, this surface mount device is intended for use in high frequency inverters, free wheeling and polarity protection applications.

### ABSOLUTE MAXIMUM RATINGS

Symbol	Parameter	Value	Unit
$V_{RRM}$	Permitive peak reverse voltage	200	V
$I_{F(RMS)}$	RMS forward current	50	A
$I_{F(AV)}$	Average forward current	$T_c=125^\circ\text{C}$ $\delta = 0.5$	A
$I_{FSM}$	Surge non repetitive forward current	$t_p=10\text{ms}$ sinusoidal	A
$I_{FRM}$	Repetitive peak forward current	$t_p = 5\mu\text{s}$ $f = 5\text{ kHz}$	A
$T_{stg}$ $T_j$	Storage and junction temperature range	- 40 to + 150	°C

## BYW77G-200

### THERMAL RESISTANCE

Symbol	Parameter	Value	Unit
R <sub>th(j-c)</sub>	Junction to case	1	°C/W

### STATIC ELECTRICAL CHARACTERISTICS

Symbol	Parameter	Test Conditions		Min.	Typ.	Max.	Unit
I <sub>R</sub> *	Reverse leakage current	V <sub>R</sub> = V <sub>RRM</sub>	T <sub>j</sub> = 25°C			25	μA
			T <sub>j</sub> = 100°C			2.5	mA
V <sub>F</sub> **	Forward voltage drop	I <sub>F</sub> = 20 A	T <sub>j</sub> = 125°C			0.85	V
		I <sub>F</sub> = 40 A	T <sub>j</sub> = 125°C			1.00	
		I <sub>F</sub> = 40 A	T <sub>j</sub> = 25°C			1.15	

Pulse test : \* t<sub>p</sub> = 5 ms, δ < 2 %

\*\* t<sub>p</sub> = 380 μs, δ < 2 %

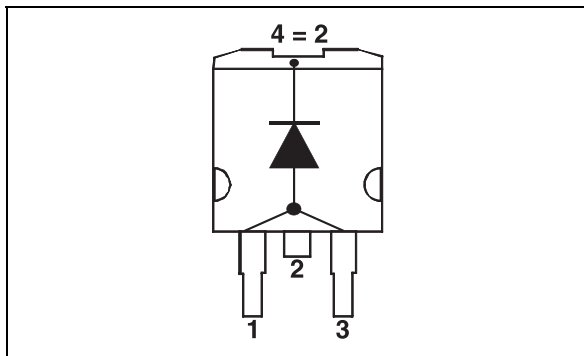
To evaluate the conduction losses use the following equation :

$$P = 0.65 \times I_{F(AV)} + 0.0075 I_{F(RMS)}^2$$

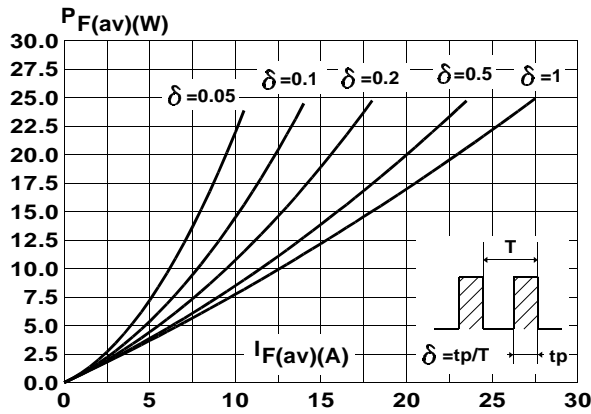
### RECOVERY CHARACTERISTICS

Symbol	Parameter	Test Conditions		Min.	Typ.	Max.	Unit
t <sub>rr</sub>	Reverse recovery time	T <sub>j</sub> = 25°C	I <sub>F</sub> = 0.5A			35	ns
		I <sub>r</sub> = 0.25 A	I <sub>R</sub> = 1A				
		T <sub>j</sub> = 25°C	I <sub>F</sub> = 1A			50	
		dI <sub>F</sub> /dt = -50A/μs V <sub>R</sub> = 30V					
t <sub>fr</sub>	Forward recovery time	T <sub>j</sub> = 25°C	I <sub>F</sub> = 1A		10		ns
		dI <sub>F</sub> /dt = 100A/μs					
		V <sub>FR</sub> = 1.1 x V <sub>F</sub> max					
V <sub>FP</sub>	Peak forward voltage	T <sub>j</sub> = 25°C	I <sub>F</sub> = 1A		1.5		V
		dI <sub>F</sub> /dt = 100A/μs					

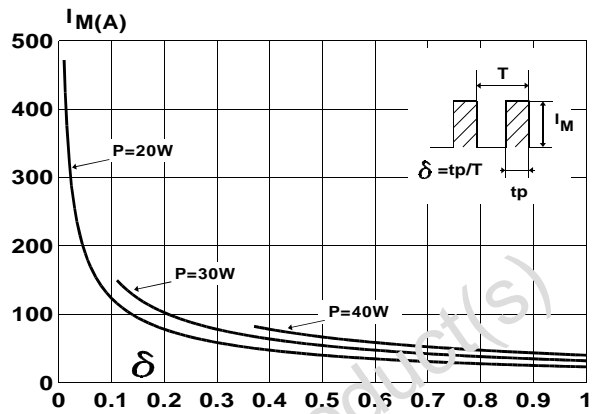
### PIN OUT configuration in D<sup>2</sup>PAK:



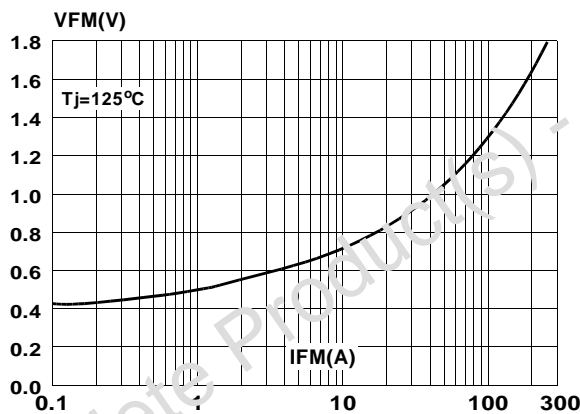
**Fig.1** : Average forward power dissipation versus average forward current.



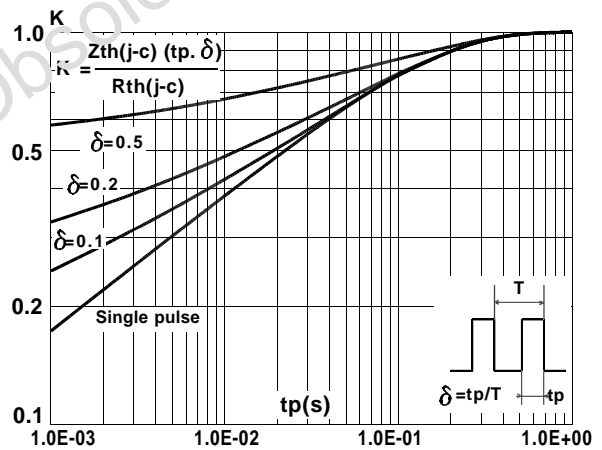
**Fig.2** : Peak current versus form factor.



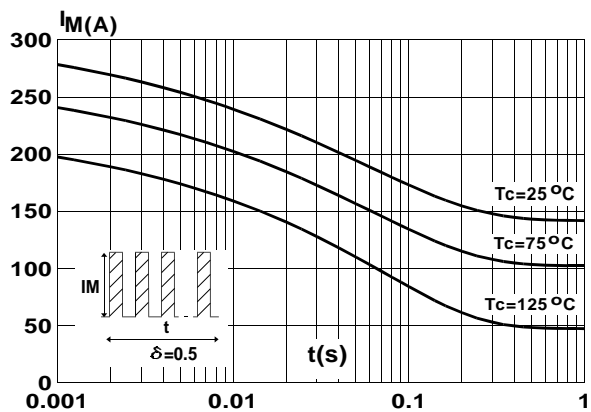
**Fig.3** : Forward voltage drop versus forward current (maximum values).



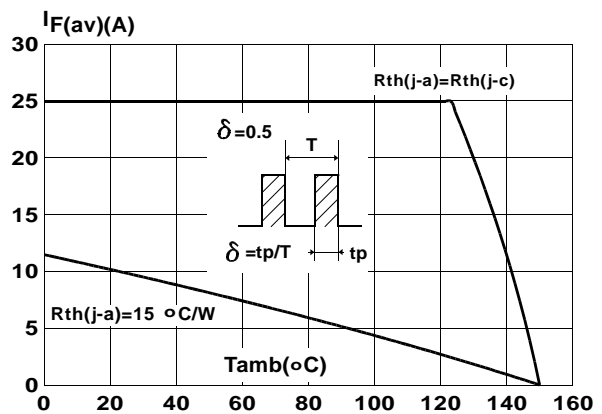
**Fig.4** : Relative variation of thermal impedance junction to case versus pulse duration.



**Fig.5** : Non repetitive surge peak forward current versus overload duration.

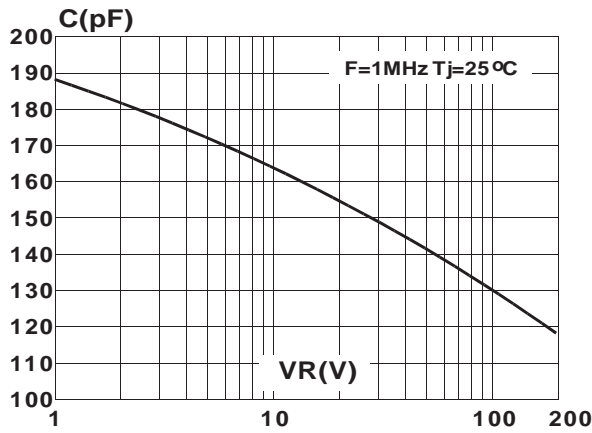


**Fig.6** : Average current versus ambient temperature. (delta = 0.5)

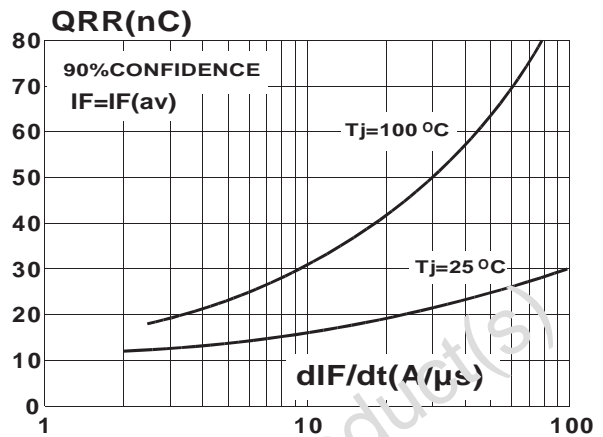


**BYW77G-200**

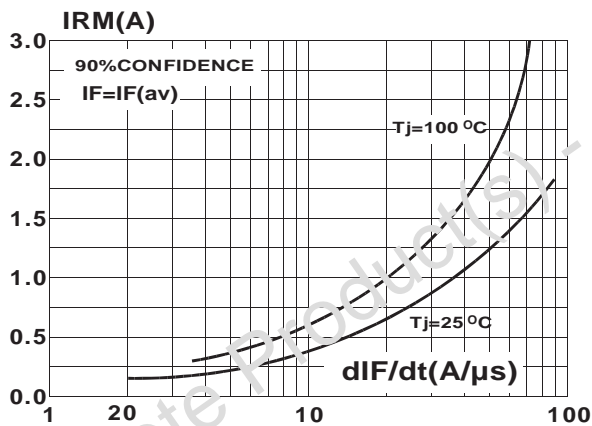
**Fig.7 :** Junction capacitance versus reverse voltage applied (Typical values).



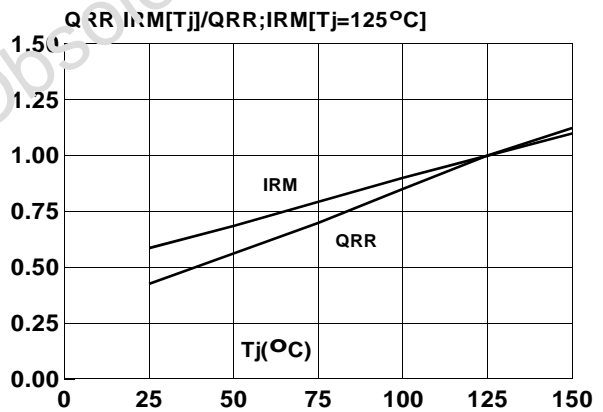
**Fig.8 :** Reverse recovery charges versus  $dI_F/dt$ .



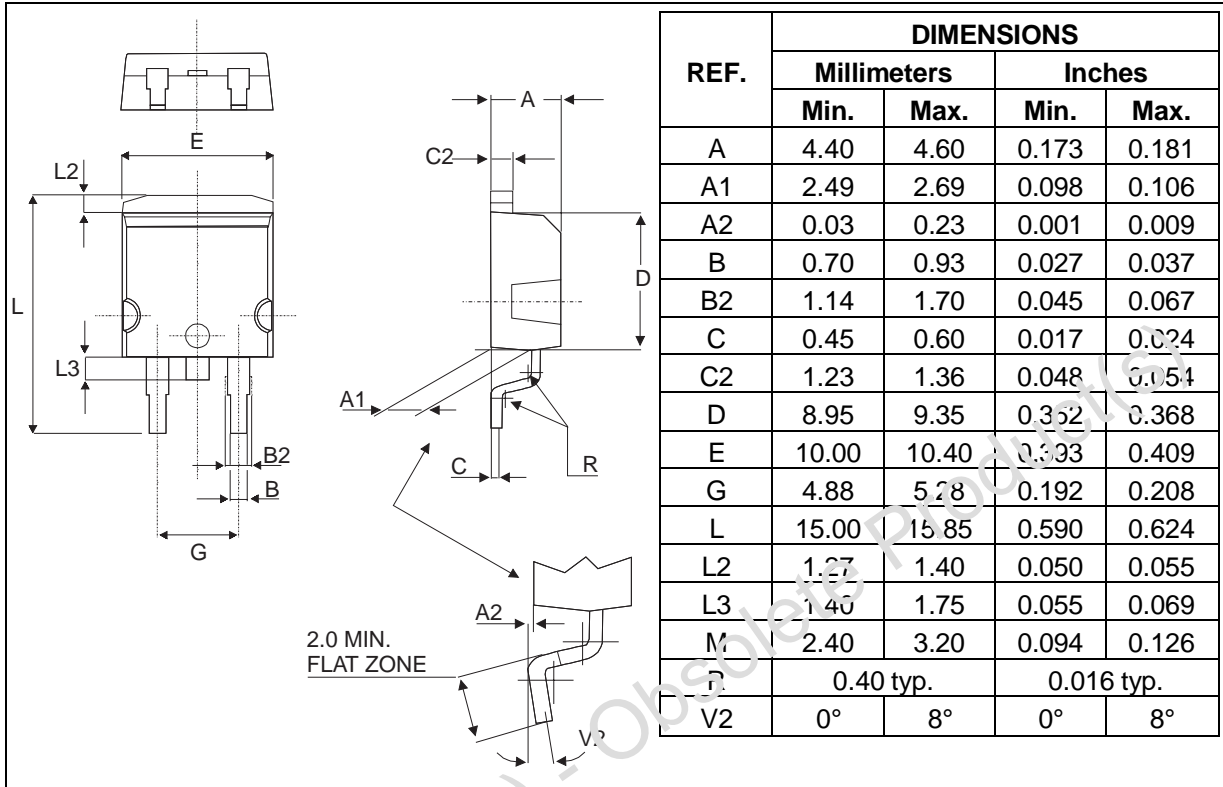
**Fig.9 :** Peak reverse current versus  $dI_F/dt$ .



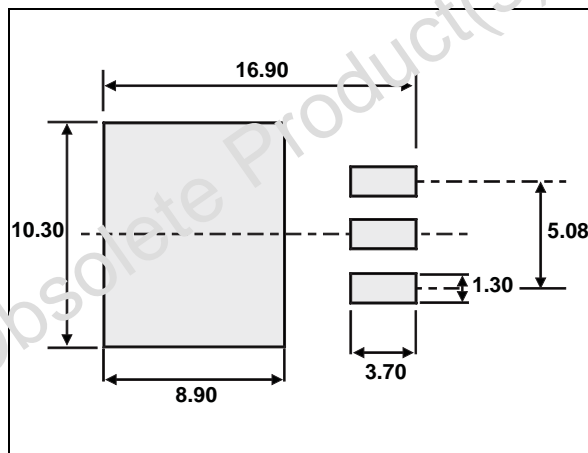
**Fig.10 :** Dynamic parameters versus junction temperature.



**PACKAGE MECHANICAL DATA**  
D<sup>2</sup>PAK (Plastic)



**FOOT PRINT (in millimeters)**



Information furnished is believed to be accurate and reliable. However, STMicroelectronics assumes no responsibility for the consequences of use of such information nor for any infringement of patents or other rights of third parties which may result from its use. No license is granted by implication or otherwise under any patent or patent rights of STMicroelectronics. Specifications mentioned in this publication are subject to change without notice. This publication supersedes and replaces all information previously supplied. STMicroelectronics products are not authorized for use as critical components in life support devices or systems without express written approval of STMicroelectronics.

The ST logo is a registered trademark of STMicroelectronics

© 1999 STMicroelectronics - Printed in Italy - All rights reserved.

STMicroelectronics GROUP OF COMPANIES

Australia - Brazil - China - Finland - France - Germany - Hong Kong - India - Italy - Japan - Malaysia  
Malta - Morocco - Singapore - Spain - Sweden - Switzerland - United Kingdom - U.S.A.

<http://www.st.com>

